

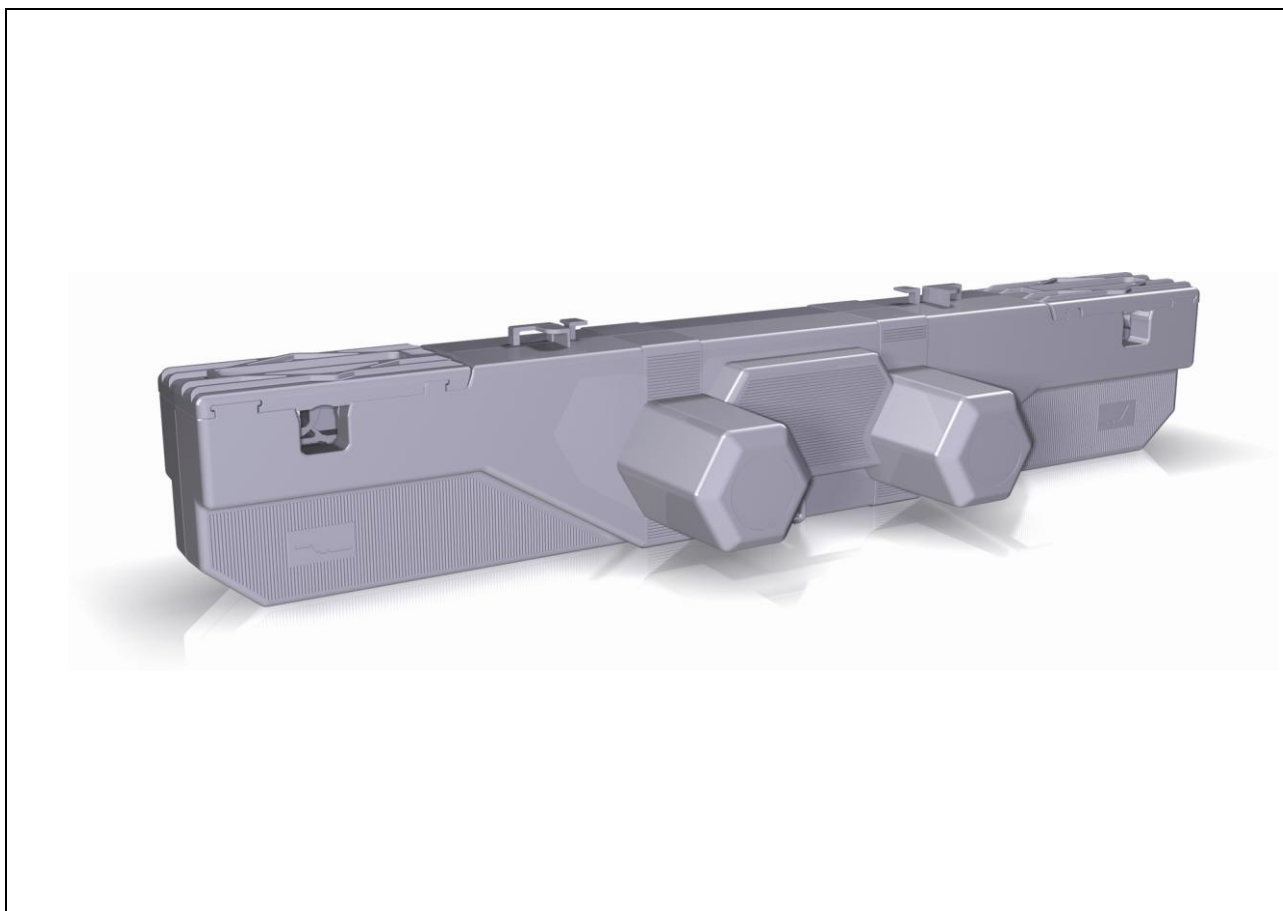

**DEWERT OKIN**

A DewertOkin Technology Group Company



# **DUOMAT 3**

## **Installation Instructions**

**(Translation of the original installation instructions)**



# Foreword

## Document revision history

| Version | Date  | Modification, change              |
|---------|-------|-----------------------------------|
| (-)     | 07/11 | First release                     |
| (a)     | 06/12 | Second edition                    |
| (b)     | 12/12 | RoHS, Safety Instructions, Toggle |

## Disclaimer and Exclusion of Liability

DewertOkin is not responsible for damage resulting from:

- failure to observe these instructions,
- changes made to this product which have not been approved by DewertOkin, or
- the use of replacement parts which have not been approved or manufactured by DewertOkin.

## Manufacturer's address

DewertOkin GmbH  
 Weststraße 1  
 32278 Kirchlengern  
 Germany  
 Tel: +49 (0)5223/979-0  
 Fax: +49 (0)5223/75182  
<http://www.dewertokin.de>  
[Info@dewertokin.de](mailto:Info@dewertokin.de)

## Creation of a complete operating instruction manual for the entire end product

These instructions are only intended to be used by the end-product manufacturer. They should not be given to the operator of the end product. The factual information contained within may be used as a basis when creating the end-product manual.

The warning and danger notices are best suited for use in the end product's manual. However it is not sufficient to simply follow these notices. You should also carry out an internal risk assessment for your end product. This can then be used as the basis for the safety notices in your manual.

These installation instructions do not contain all information required to safely operate the end product. They only describe the installation and operation of the drive as partially completed machinery.

The instructions are intended for the technicians responsible for manufacturing an end product and not for the operators of the end product.

**Notice for customers in EU nations**

**German Inspection Authority (TÜV) testing label**

The construction of the DUOMAT 3 has been inspected by the German Inspection Authority (TÜV). The TÜV also monitors the production of the DUOMAT 3. The official German TÜV label certifies this construction inspection and production monitoring.

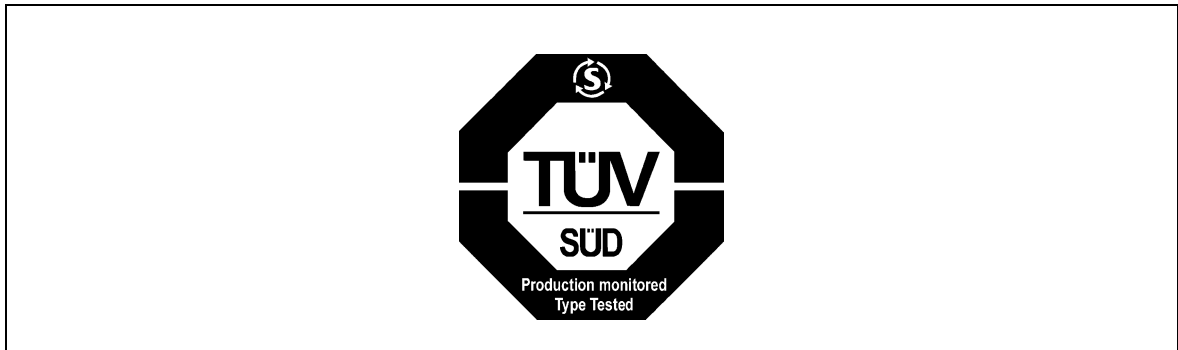

Figure 1 The TÜV label

# Table of Contents

|  |           |
|--|-----------|
| <b>Foreword</b>  | <b>3</b>  |
| Document revision history  | 3         |
| Disclaimer and Exclusion of Liability  | 3         |
| Manufacturer's address   | 3         |
| Creation of a complete operating instruction manual for the entire end product                               | 3         |
| Notice for customers in EU nations   | 4         |
| <b>Table of Contents</b>   | <b>5</b>  |
| <b>1. General information</b>  | <b>7</b>  |
| 1.1 Configurations   | 7         |
| 1.2 About these installation instructions  | 7         |
| 1.3 Availability of this document  | 7         |
| 1.4 Conventions used   | 8         |
| <b>2. Safety Instructions</b>  | <b>9</b>  |
| 2.1 Proper and Intended Usage  | 9         |
| 2.2 Safety notices within the installation instruction and the operating instructions for the entire machine | 10        |
| 2.3 Selection and qualification of personnel   | 10        |
| 2.4 Notice on safety during operations   | 11        |
| 2.5 Product identification   | 12        |
| <b>3. Possible Combinations</b>  | <b>14</b> |
| <b>4. Description</b>  | <b>15</b> |
| 4.1 Components   | 15        |
| <b>5. Technical Specifications</b>   | <b>17</b> |
| <b>6. Installation</b>   | <b>19</b> |
| 6.1 Safety notices to observe during installation  | 19        |
| 6.2 Installation procedure   | 20        |
| 6.3 Move your product into a position where it is supporting no load.  | 21        |
| <b>7. Operating Notes</b>  | <b>26</b> |
| 7.1 General information  | 26        |
| 7.2 Notice for operating with optional configuration   | 28        |
| <b>8. Troubleshooting</b>  | <b>30</b> |
| 68010(b)   | 5         |

|            |                              |           |
|------------|------------------------------|-----------|
| <b>9.</b>  | <b>Maintenance</b>           | <b>31</b> |
| 9.1        | Maintenance                  | 31        |
| 9.2        | Cleaning and care            | 32        |
| <b>10.</b> | <b>Disposal</b>              | <b>33</b> |
|            | Declaration of incorporation | 34        |
|            | EU Declaration of Conformity | 35        |
|            | Additional information       | 36        |

# 1. General information



## 1.1 Configurations

The DUOMAT 3 double drive is run in several different configurations. The "Possible Combinations" chapter includes information about the different device combinations available.

## 1.2 About these installation instructions

These installation instructions must be followed closely in order to install this drive successfully and safely in the end product. These instructions are not an operating manual for the end product.

These instructions will help you to minimize danger, repair costs and down times. They will also help you to maximize the reliability and lifespan of the end product.

|   |
|---|
|  <b>CAUTION</b>  |
|  <p>The notices in these instructions must be followed! Following the guidelines during installation and connection procedures will help to minimize:</p> <ul style="list-style-type: none"> <li>• the risk of accident and injury, and</li> <li>• damage to the drive system or the end product.</li> </ul> |

These installation instructions have been written with due care and attention. However, we cannot guarantee that the data, images and drawings are complete and correct nor do we accept any liability for the information contained therein, unless required by law.

- ▶ We reserve the right to make unannounced technical changes in the course of our continual product improvement process!

## 1.3 Availability of this document



As manufacturer of the end product, you are obligated to comply with Machinery Directive 2006/42/EC. This directive stipulates that the installation instructions must be kept on file for governmental inspection purposes.



### 1.4 Conventions used



Notices which do not relate to safety are indicated in these instructions with a triangle:

- ▶ Triangular notice symbol

#### Safety notice explanations

|   |   |
|---|---|
|  |  <b>DANGER</b>       |
|   | DANGER indicates a hazardous situation which, if not avoided, will result in serious injury or death. |

|   |  |
|---|--|
|  |  <b>WARNING</b>       |
|   | DANGER indicates a hazardous situation which, if not avoided, could result in serious injury or death. |

|   |  |
|---|--|
|  |  <b>CAUTION</b>       |
|   | CAUTION indicates a hazardous situation which, if not avoided, could result in minor or moderate injury. |

|   |   |
|---|---|
|  | <b>NOTICE</b>   |
|   | NOTICE is used to address practices which are not related to personal injury but may result in damage to the product or surroundings. |





## 2. Safety Instructions

### 2.1 Proper and Intended Usage



The DUOMAT 3 drive is meant to be installed in beds.



- It provides motor adjustment capabilities for movable reclining bed parts. It should be used in conjunction with suitable brackets and mechanics.
- It can be used for care purposes (CARE)
- It can be used in a hospital (HOSP).



|  |
|--|
|  <b>CAUTION</b>   |
|  <p>This drive should only be used for the applications described above. Any other form of usage is not permitted and can lead to accidents or destruction of the unit. Such non-approved applications will lead immediately to the expiration of all guarantee and warranty claims on the part of the end-product manufacturer against the manufacturer.</p> |

#### Improper usage



Be sure to follow the notices below concerning improper usage. You should include them in your product manual in order to inform the users of your end product.

|   |
|---|
|  <b>WARNING</b>  |
|  <p>The DUOMAT 3 drive should not be used:</p> <ul style="list-style-type: none"> <li>• in any environment where combustible or explosive gases or vapours (e.g., anaesthesiology) may be present,</li> <li>• in a moist environment,</li> <li>• outdoors,</li> <li>• in any application that will be cleaned with an automated washing system,</li> </ul> |

|  |
|--|
|  <b>CAUTION</b>   |
|  <p>The DUOMAT 3 drive may not be operated:</p> <ul style="list-style-type: none"> <li>• by small children,</li> <li>• by frail or infirm persons without supervision, or</li> <li>• in the proximity of small children.</li> </ul> |

|  |
|--|
|  <b>CAUTION</b>   |
|  <p>You should only use spare parts which have been manufactured or approved by DewertOkin. Only these parts will guarantee a sufficient level of safety.</p> |

**Optional: battery-operated reset function**

|   |  |
|---|--|
|      |  <b>CAUTION</b> |
| The battery-operated reset function is not a safety system and does not avert danger. |  |

DewertOkin does not guarantee that the drive will function in the event of a power outage.

If the end-product manufacturer chooses to guarantee the functionality of the end product during a power outage, then the end-product manufacturer is responsible for arranging a mechanism to ensure this functionality.

**2.2 Safety notices within the installation instruction and the operating instructions for the entire machine**

The manufacturer of the end product is only permitted to operate the DUOMAT 3 drive (by itself an incomplete machine)

- when the end product (for which the DUOMAT 3 drive is intended) is in compliance with all protective measures specified in the Machinery Directive 2006/42/EC, and
- when the manufacturer expressly declares the compliance of the end product.

The manufacturer of the end product must create a manual for the users of that product. The safety notices in the end-product manual must be written based on the end product's risk assessment.

**2.3 Selection and qualification of personnel**

This drive should only be installed into the end product by someone who has completed training in electronic motor assembly or has equivalent qualifications.

You should only install this drive when you are qualified to do so. Otherwise, a properly qualified person should be found for this task.

## 2.4 Notice on safety during operations

Basic safety rules must be followed in order to ensure that the end product can be continually operated in a safe manner. These rules must be observed while using the end product and while installing the drive.

These rules and safety measures can be categorized as follows:

- Construction measures before the installation (refer to the "Ensuring operational reliability during installation" section in the "Installation" chapter).
- Safety fundamentals during the drive installation and during cable and wire routing (refer to the "Safety notices to observe during installation" section in the "Installation" chapter).
- Using the drive in intermittent duty (refer to the "General information" section in the "Operating Notes" Chapter).
- Basic safety rules during operation (refer to the "Operating Notes" Chapter).
- The creation of a manual for the end product which contains these and other safety rules.

### Creating a user's manual

The manufacturer of the end product must create a manual for the users of that product. The safety notices in the end-product manual must be written based on the end product's risk assessment.

**2.5 Product identification**

**2.5.1 Type plate**

A ratings plate on each drive specifies the exact name and serial number of the drive. It also states the technical specifications valid for that particular drive. In particular, you will find the maximum pull force and the maximum push force here. The following illustration shows where the specifications are located on the drive's ratings plate.

- ▶ The ratings plate shown is an example; the specifications for your drive may differ from this illustration.

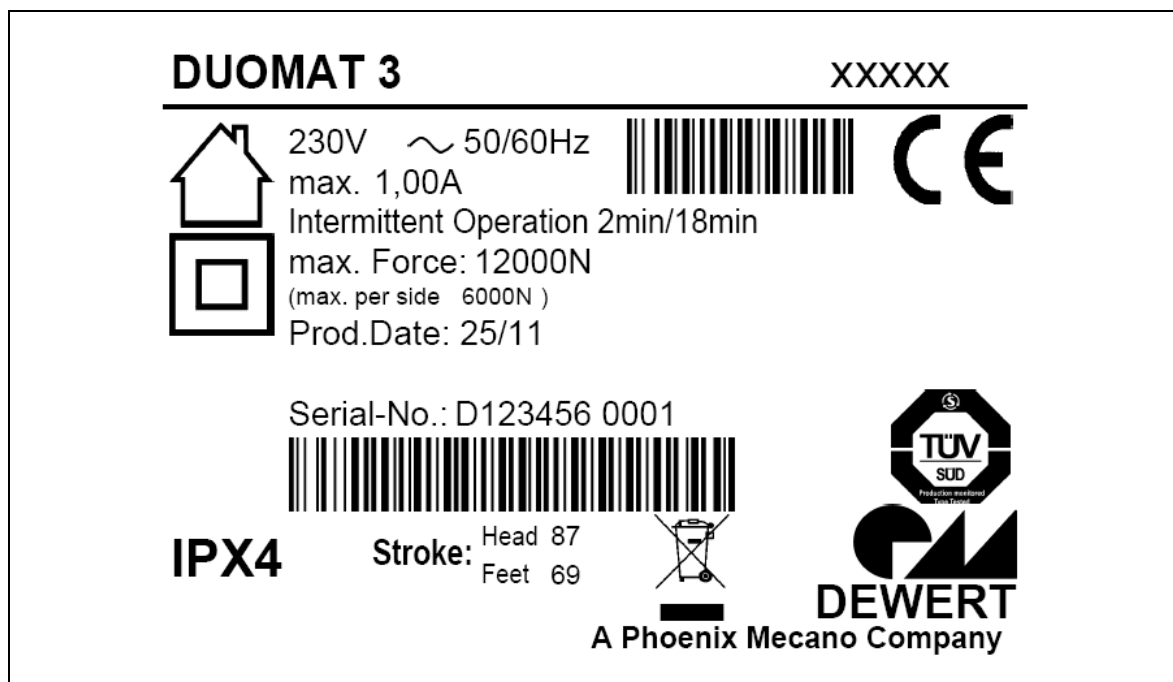





Figure 2 Ratings plate example

|                                   |   |
|-----------------------------------|---|
| <b>DUOMAT 3</b>                   | <b>Model name</b>                               |
| xxxxx                             | Article No:                                     |
| 230V ~ 50/60Hz                    | Input voltage and frequency                     |
| Max. 1.00A                        | Rating of fuse                                  |
| Intermittent Operation 2min/18min | Intermittent operations: 2 minutes / 18 minutes |
| Max. force                        | Push force                                      |
| Prod.date                         | Calendar week / year                            |
| Serial No.                        | Serial number for your drive                    |
| IPX4                              | Protection degree                               |
| Stroke                            | Stroke (head / foot)                            |

|   |   |
|---|---|
|  | Use in dry rooms only!                    |
|  | Protection class II                       |
|  | Follow all special disposal instructions! |
|  | Conformity mark                           |

### 3. Possible Combinations

The DUOMAT 3 double drive can be combined for use with other single or double drives. The following basic combinations are possible:

- a DUOMAT 3 with a handset,
- a DUOMAT 3 as the main drive and a single drive used as a slave drive with a handset,
- a DUOMAT 3 as the main drive and two single drives used as a slave drives with a handset,

Systems can be customized by combining drives with the handset and control units as needed. The system components must be connected in a specific order.

DewertOkin has separate system instruction manuals containing all information and instructions needed for these systems.

- ▶ Only a DewertOkin device should be used to control the drive since they have already been verified to work together.

## 4. Description

The DUOMAT 3 drive is an electrically driven motor that is responsible for moving the end product in a linear direction. The head and foot sections of a bed can be adjusted depending on the drive options. The drive is controlled by means of a handset.

The different drive models vary according to the:

- motor power,
  - number of motors,
  - model with optional reset function,
  - model with optional mains cut-off mechanism,
  - with external SMPS (EPS),
  - with integrated SMPS (IPS).
- We reserve the right to make unannounced technical changes in the course of our continual product improvement process!
- The "Possible Combinations" Chapter describes the different possible combinations of drives and handsets/hand-held remote controls. You can also ask your supplier or dealer for additional information.

### 4.1 Components

The main components of the DUOMAT 3 drive are the motor and the adjustment motion mechanism. This mechanism is housed under the shutters. The shutters must be opened in order to mount the drive to the end product. The brackets fastened to the end product are then inserted into these openings.

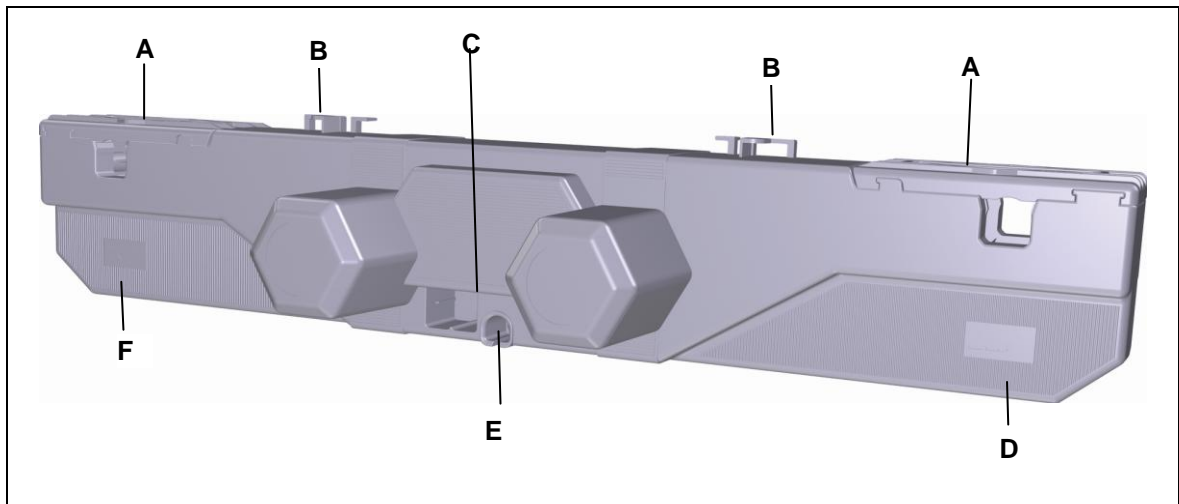



Figure 3 Main components of the DUOMAT 3 double drive



- |   |                                     |
|---|-------------------------------------|
| <b>A</b> Shutters                               | <b>B</b> Strain relief              |
| <b>C</b> Battery compartment with 9-V batteries | <b>D</b> Symbol for head end of bed |
| <b>E</b> Power cord                             | <b>F</b> Symbol for foot end of bed |

#### 4.1.1 Mains power supply

|   |  |
|---|--|
|    |  <b>WARNING</b> |
| <p>Please follow these operating instructions carefully. You could be injured by fire or electrical shock if you do not follow these assembly instructions.</p> |  |

#### Plug versions

The appropriate power cable is included, depending on the regional version (USA, continental Europe, the UK or Australia).

|  |  |
|--|--|
|   |  <b>WARNING</b> |
| <p>Only use the proper power cable that is permitted in your country. Be sure to use the correct plug adapter, as described in Figure 4.</p> |  |

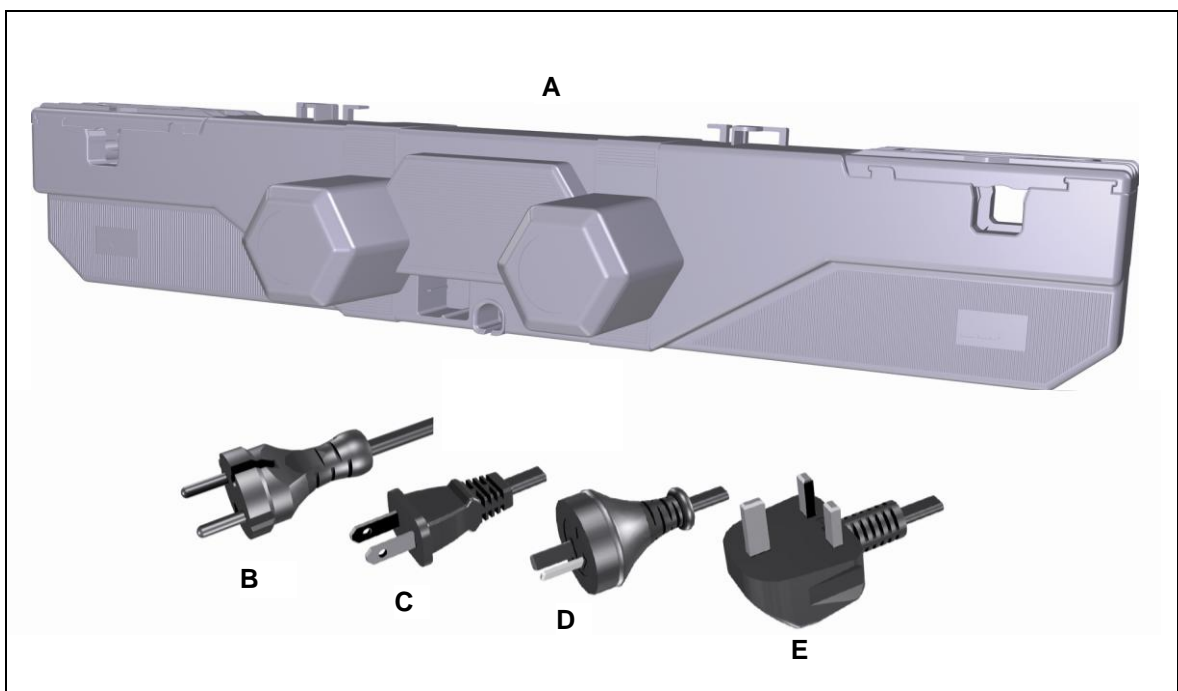

Figure 4 Power cord, regional variants

**A** The DUOMAT 3 double drive

**C** Power plug (USA version)

**E** Power plug (United Kingdom version)

**B** Power plug (German version)

**D** Power plug (Australian version)



## 5. Technical Specifications

|  |   |
|--|---|
| Connection to mains power (AC)<br>or<br>Input voltage (DC)     | 100 V - 240 V AC, 50/60 Hz (refer to the ratings plate on the drive)<br>24 V DC - 29 V DC (refer to the ratings plate on the drive) |
| Current consumption at rated load                              | Max. 8.0 A DC   |
| Permitted push force   | Max. 6000 N   |
| Mode of operation <sup>1</sup> under max. rated load           | Intermittent duty 2 min./18 min.  |
| Protection class   | II  |
| Noise level  | ≤ 65 dB(A)  |
| Fuse   | T 3.15 A, depending on mains power connection (refer to the drive's ratings plate)  |
| Drive type   | Double drive  |
| Protection degree  | IPX4  |
| Stroke <sup>2</sup>  | 87, 69 (standard)   |
| Colours  | Refer to sales brochure   |
| Length x width x height  | 708 mm x 166 mm x 120 mm  |
| Axle gap distance  | 581 mm  |
| Weight   | Approx. 5 kg  |
| <b>Optional: battery-operated reset function</b>               |   |
| Voltage  | One or two 9-V batteries (type 6LR61) depending on version  |
| <b>Ambient conditions for operation, storage and transport</b> |   |
| Transport / storage temperature                                | From -20 °C to +50 °C<br>From -4 °F to +122 °F  |
| Operating temperature  | From +10 °C to +40 °C<br>From +50 °F to +104 °F   |
| Relative humidity  | From 30% to 75%   |
| Air pressure   | From 800 hPa to 1060 hPa  |
| Altitude   | < 2000 m  |

<sup>1)</sup> Mode of operation: intermittent duty 2 min./18 min. This means that after the unit is operated with its rated load for up to two minutes it must then be paused for 18 minutes. The system can malfunction if this pause is not observed!

<sup>2)</sup> Other stroke distances are available on request.

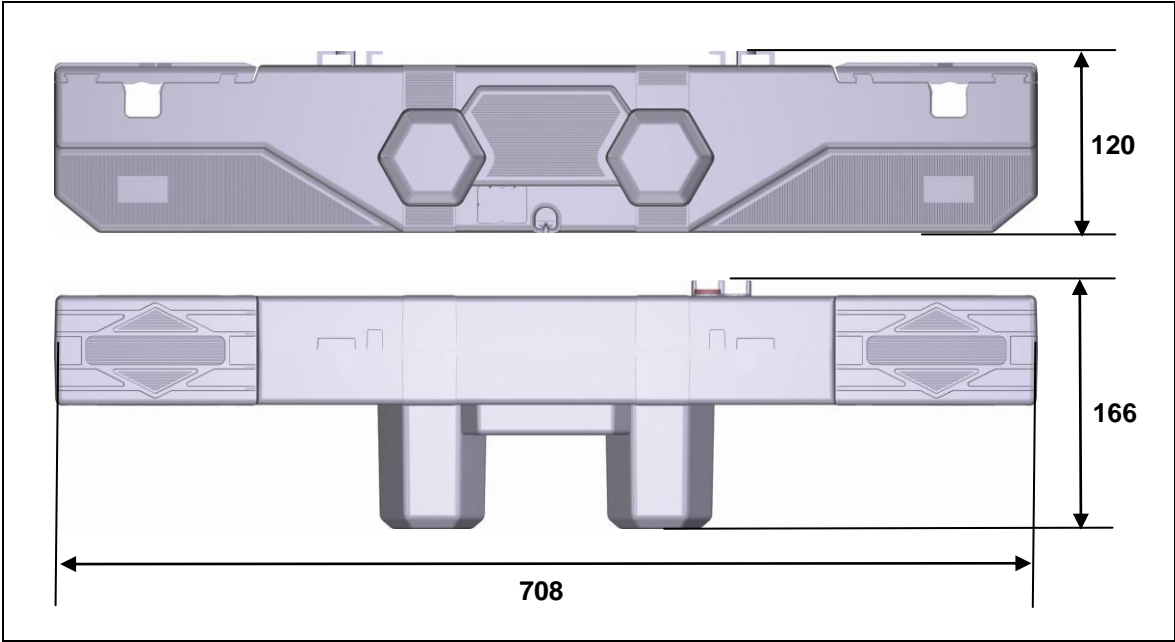

Figure 5 Dimensions of DUOMAT 3 drive (in mm)

## 6. Installation



### 6.1 Safety notices to observe during installation

Basic safety rules must be followed in order to ensure that the end product can be continually operated in a safe manner. These rules must be observed while using the end product and while installing the drive.



#### 6.1.1 Ensuring operational reliability during installation

The safety and reliability of the end product containing the DewertOkin drive can be ensured by using the proper construction methods described below.

#### Avoiding fatigue fractures

|  |
|--|
|  <b>CAUTION</b>   |
| <div style="display: flex; align-items: center;">  <div> <p>Drives that are incorrectly installed can undergo fatigue fractures which then create a risk of injury.</p> <ul style="list-style-type: none"> <li>• Install the drive in the end product so that it is properly aligned. This will help prevent shear stress.</li> <li>• Do not position the drive at a slanted angle when installing it in the end product. A slanted angle between the intended direction of movement of the end product and the drive's direction will create shear stress and could lead to a fatigue fracture.</li> </ul> </div> </div> |

#### Avoiding a pinching hazard

|   |
|---|
|  <b>CAUTION</b>  |
| <div style="display: flex; align-items: center;">  <div> <p>When designing your end product, you should take the drive adjustment movement into account with passive safety mechanisms and with the appropriate safety notices in your operating instructions.</p> <ul style="list-style-type: none"> <li>• Installation methods for ensuring passive safety: Install the DUOMAT 3 drive so that none of the positions where shear and pinch hazards exist are accessible externally.</li> </ul> </div> </div> |

When preparing safety notices for the operator, be sure that your operating instructions inform the user of these points.

## 6.2 Installation procedure

### 6.2.1 An example installation

Before installing the drive, make sure that you are observing all of the safety notices found in the "Safety notices to observe during installation" section.

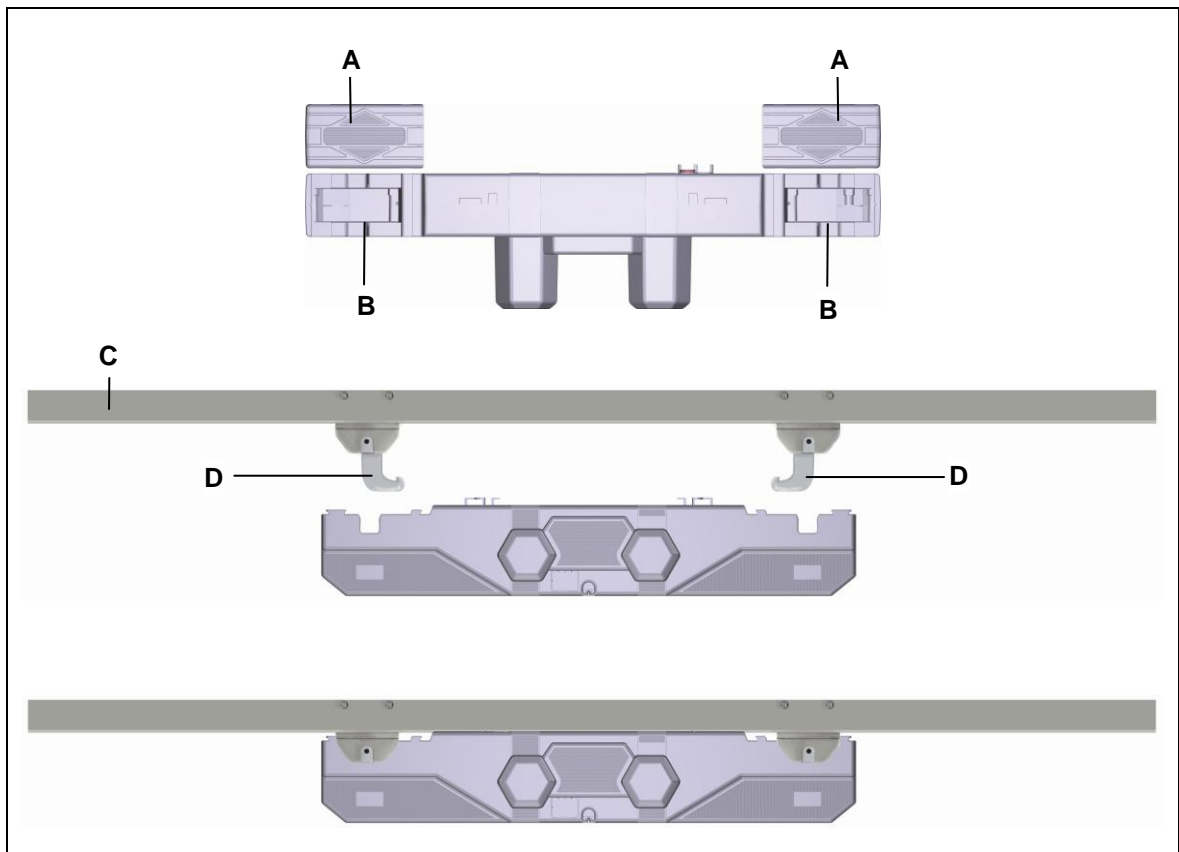

Figure 6 Installing the double drive



**A** Shutters



**B** Fitting mounts

**C** End product (bed)

**D** Brackets



- 1 Move your product into a position where it is supporting no load.

|   |   |
|---|---|
|  |  <b>CAUTION</b>  |
|   | Be sure to carry out work on the drive in a position so that no loads are bearing on it. Only in this way can you be sure to avoid any risks of crushing or injury. |



|   |  |
|---|--|
|  |  <b>CAUTION</b> |
|   | Disconnect the batteries if you are using the battery-operated reset function.                   |

- 2 Pull strongly on the shutters to the side (A). The slots (B) for the brackets (D) are uncovered.
- 3 Align the DUOMAT 3 next to your product. The slots for the head and foot sides must be properly aligned with the correct brackets on your product (refer to the symbols on the DUOMAT 3 as described in Figure 3).
- 4 Push the drive in so that the brackets (D) fit into the slots (B). Press in until the tubes snap into the brackets.
- 5 Close the shutters (A) on the drive by snapping them back in. The DUOMAT 3 is now securely attached to the end product.
- 6 Disconnect all additional components such as slave drives or handset from their sockets.
- 7 Close off the unused sockets using dummy plugs. The dummy plugs ensure that the sockets are properly protected against any splashed water.
- 8 Connect the mains power plug.

6.2.2 Electrical connection

|   |   |
|---|---|
|  |  <b>CAUTION</b>        |
|   | Electrical components should be connected or disconnected only when the power supply cord is unplugged. |

Power cord

|   |  |
|---|--|
|  |  <b>WARNING</b>   |
|   | <p>Only personnel with the following training are qualified to work on the power cord or to replace the power cord:</p> <ul style="list-style-type: none"><li>• someone who has completed training in electronic motor assembly or,</li><li>• someone with equivalent qualifications, or</li><li>• someone who has successfully completed the appropriate DewertOkin training program.</li></ul> <p>You should only work on the attached power cord when you are qualified to do so. Otherwise, a properly qualified person should be found for this task.</p> |

**Optional: battery-operated reset function**  
**Connecting the 9-V batteries**

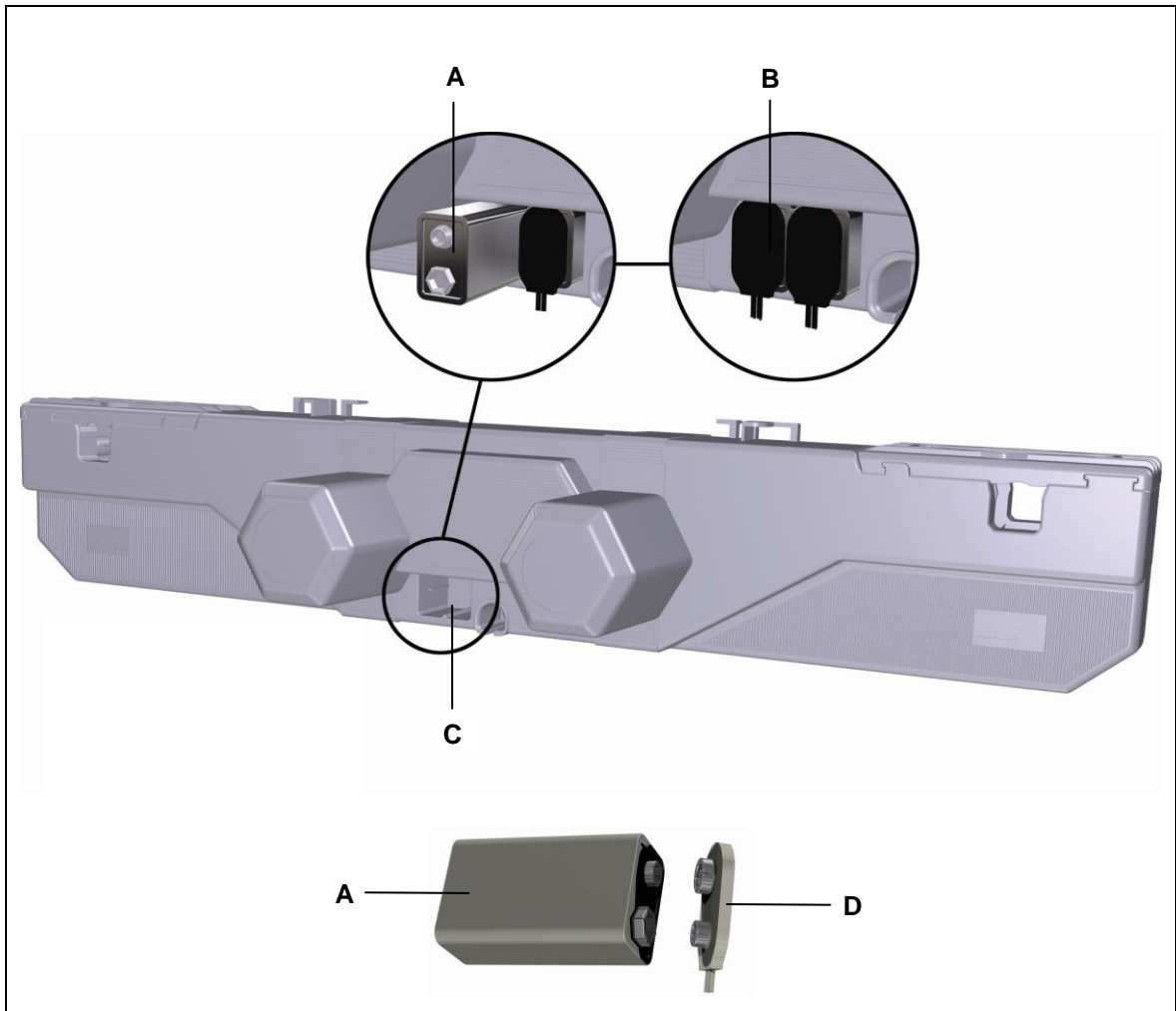

Figure 7 Connecting the 9-V batteries

**A** 9-V battery (type 6LR61)

**B** Battery clip, attached

**C** Battery compartment

**D** Battery clip, unattached

|                  |   |
|------------------|---|
| <b>⚠ CAUTION</b> |   |
|                  | <p>Connect the nine-volt batteries first when you would like to perform a battery-operated reset. The batteries may only be used to power the reset function one time. Take out the batteries and dispose of them properly after the reset function has been carried out.</p> |

**Routing the electrical cables**



When routing the cables, be sure that:

- the cables cannot get jammed,
- no mechanical load (such as pulling, pushing or bending) will be put on the cables, and
- the cables cannot be damaged in any way.

Fasten all cables (especially the mains cable) to the end product using sufficient strain relief and kink prevention methods. Be sure that the design of the end product prevents the mains cable from coming into contact with the floor during transport.





6.2.3 Dismantling



|   |  |
|---|--|
|  |  <b>CAUTION</b>     |
|   | Work on electrical components should be conducted only when the mains power connection is unplugged. |

► Certain details may change as a result of technical changes.

- 1 Move your product into a position where it is supporting no load.

|   |   |
|---|---|
|  |  <b>CAUTION</b>  |
|   | Be sure to carry out work on the drive in a position so that no loads are bearing on it. Only in this way can you be sure to avoid any risks of crushing or injury. |

- 2 Pull out the mains power plug!

|   |  |
|---|--|
|  |  <b>CAUTION</b>                       |
|   | Disconnect the batteries if you are using the battery-operated reset function. Disconnect the nine-volt block batteries. |



- 3 Disconnect all additional components such as slave drives or handset from their sockets.
- 4 Pull strongly on the shutters to the side (A).
- 5 Pull out the DUOMAT 3 far enough so that the brackets (D) are out of the slots (B). The DUOMAT 3 is now unattached and can be removed.

|   |  |
|---|--|
|  | <b>NOTICE</b>  |
|   | Be sure to support the drive's weight to prevent it falling. |

- 6 Push the shutters (A) back onto the DUOMAT 3 so that they are not lost during transportation.

## 7. Operating Notes

The factual information contained within may be used when you are creating the end-product manual. The installation instructions do not contain all information required for the safe operation of the end product. They only describe the installation and operation of the drive as a partially assembled piece of machinery.

|   |   |
|---|---|
|  |  <b>CAUTION</b>  |
|   | <p>When creating the operating instructions, remember that the installation instructions are intended for qualified specialists and are not for typical users of the end product.</p> |

### 7.1 General information

- ▶ Only a DewertOkin device should be used to control the drive since they have already been verified to work together.

#### Power-on time / intermittent operations

The DUOMAT 3 drive has been designed for intermittent operations. Intermittent operation is an operational mode where the drive must pause after a specified maximum period of operation (power-on time). This protects the drive from overheating. In an extreme case, overheating can lead to a malfunction.



- ▶ The ratings plate on the drive specifies the maximum power-on time and the required pause intervals.

#### Avoiding toggle operations



You should avoid switching from one direction of travel to the opposite direction without first stopping the motor. – Make sure that you pause between motions! A pause (motor stop time) can be activated using the operating element or handset.

|   |   |
|---|---|
|  | <b>NOTICE</b>   |
|   | <p>You should always avoid a quick change ("toggle") of directions.</p> |

#### Avoiding electrical risks



|   |   |
|---|---|
|  |  <b>WARNING</b>  |
|   | <p>Be sure that all live (current-carrying) parts of the drive system and power supply cannot be touched. In particular, be sure that unused power and control unit connections are covered adequately.</p> |

**Shutting off the drive**

|   |  |
|---|--|
|  |  <b>CAUTION</b>   |
|   | Pull out the power plug in order to shut off the drive. The power plug must always be accessible during operations so that emergency shut-off is possible. |

**Avoiding cable damage**

Be sure that your operating instructions inform the user about the possible cable risks.

|   |  |
|---|--|
|  |  <b>CAUTION</b>   |
|   | The cables (particularly the mains cable) should not be run over. In order to prevent injuries or drive damage, no mechanical strain should be placed on the cables. |

**Looping the handset cable through the strain relief mechanism**

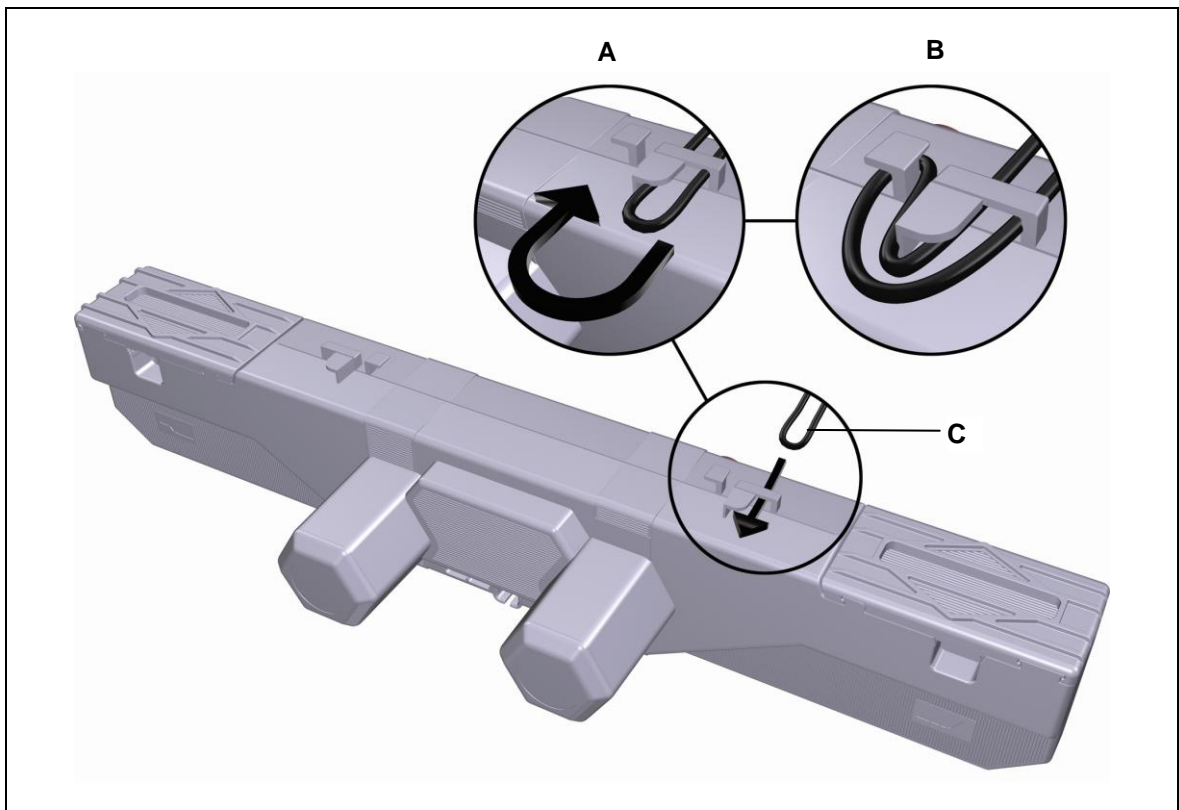

Figure 8 Looping the cable through the strain relief mechanism

**A** Looped-in cable

**B** Secured cable

**C** Handset cable loop

- 1 Connect the plug from the handset to the handset socket on the DUOMAT 3.
- 2 Loop the handset cable through the strain relief catch and pull back gently on the loop as illustrated in Figure 8.

## 7.2 Notice for operating with optional configuration

### 7.2.1 Optional: battery-operated reset function

The battery-operated reset function allows the drive system to be operated during a power outage. One or two nine-volt batteries can be used to power the DUOMAT 3 in the event of a power outage. The batteries should be connected only then when the outage occurs. The batteries are not connected by default since they have limited capacity. They can only be used to power the reset function once. The used batteries should then be replaced and properly disposed of.

|   |                  |
|---|------------------|
|      | <b>! CAUTION</b> |
| The battery-operated reset function is not a safety system and does not avert danger. |                  |

|  |                  |
|--|------------------|
|   | <b>! CAUTION</b> |
| Connect the nine-volt batteries first when you would like to perform a battery-operated reset. The batteries may only be used to power the reset function one time. Take out the batteries and dispose of them properly after the reset function has been carried out. |                  |

- ▶ If the end product is under a heavy load which prevents the reset function from operating, the strain or load on the end product must first be removed before a reset can be carried out.

### 7.2.2 Optional: the mains cut-off mechanism



The mains cut-off feature is only available with the attached power cord variants. The mains cut-off mechanism is responsible for isolating the drive automatically from the mains power supply when the drive is not moving. A switching component is used to isolate both poles of the power transformer from the mains power supply.

The mains cut-off mechanism allows power to the drive only after a button has been pressed on the handset to trigger drive motion.

► Do not use the integrated mains cut-off if you already use an in-house mains cut-off system.



If you have purchased the DUOMAT 3 with the mains cut-off function, then you should note the following:

- After a long period not being used, the capacitor can lose its voltage. The built-in nine-volt battery buffers the mains cut-off capacitor.
- In the very unlikely event that the battery is also empty, it is still possible to use the device without problems. Press the green button on the mains cut-off. The capacitor is charged up immediately, and the mains cut-off is ready for use again.

|   |  |
|---|--|
|  | <b>WARNING</b>   |
|   |  <p>The mains cut-off is not a "central command device" in the sense used by the DIN VDE regulations. You should first completely disconnect the voltage supply from the drive system before conducting any type of work on a DewertOkin product which features a mains cut-off. First pull out the power plug. This guarantees that the system is safely shut off in compliance with the German DIN VDE 0105 and BGV A3 regulations.</p> |

## 8. Troubleshooting

This chapter describes troubleshooting methods for fixing problems. If you experience an error that is not listed in this table, please contact your supplier.

|   |  |
|---|--|
|  |  <b>CAUTION</b>                       |
|   | <p>Only qualified specialists who have received electrician training should carry out troubleshooting and repairs.</p> |

| Problem   | Possible cause  | Solution  |
|---|---|---|
| The handset or drive system is not functioning. | There is no mains supply voltage.   | Connect the mains power.  |
|   | The hand switch or drive system is defective.   | Please contact your supplier or sales agent.                      |
| The drive is suddenly not capable of movement.  | Possibly the thermal circuit breaker on the transformer has been triggered or is defective. | The drive system should be allowed to pause for 20 to 30 minutes. |
|   | The thermal fuse on the transformer may have been triggered or may be defective.            | Please contact your supplier or sales agent.                      |
|   | The unit's fuse may have been triggered or may be broken.                                   | Please contact your supplier or sales agent.                      |
|   | There is no mains supply voltage.   | Connect the mains power.  |
|   | A lead-in connection has been interrupted (mains power, hand switch or auxiliary drive).    | Check the cables and reinsert them, if required.                  |
| The battery-operated reset is not functioning.  | The batteries are empty.  | Check the batteries and replace if necessary.                     |
|   | Battery is not connected.   | Connect the batteries.  |

## 9. Maintenance

- ▶ You should only use spare parts which have been manufactured or approved by DewertOkin. Only these parts will guarantee a sufficient level of safety.

### 9.1 Maintenance

| Type of check   | Explanation  | Time interval   |
|---|--|---|
| Check the function and safety of the electrical system.                             | A qualified electrician should carry out this inspection. (Refer to the "Electrical connection" section in the "Installation" Chapter.)                      | Periodic inspections can be carried out at intervals based on the risk assessment which you conduct for your end product. |
| Look over the housing periodically for any signs of damage.                         | Check the housing for breaks or cracks. The IP-class protection will be impaired by any breakage or cracks.  | At least every six months.  |
| Look over the plug-in connections and electrical access points for signs of damage. | Check that all electrical cables and connections are firmly seated and correctly positioned.   | At least every six months.  |
| Look over the cables for any signs of damage.                                       | Check the connecting cables for pinching or shearing. Also check the strain relief and kink protections mechanisms, in particular after any mechanical load. | At least every six months.  |
| Periodic functional test of the end switches.                                       | Move the drive to the end positions in order to test the end switches.   | At least every six months.  |

## 9.2 Cleaning and care

The DUOMAT 3 drive was designed so that it would be easy to clean. The smooth surfaces can be conveniently cleaned.

|   |  |
|---|--|
|  | <b>NOTICE</b>  |
|   | Never clean the drive in an automated washing system or with a high-pressure cleaner. Do not allow fluids to penetrate the drive. Damage to the system could result. |

- 1 Always disconnect the mains power plug before you start to clean the drive!

|   |  |
|---|--|
|  | <b>CAUTION</b>   |
|   | Disconnect the batteries if you are using the battery-operated reset function. Disconnect the nine-volt block batteries. |

- 2 Clean the DUOMAT 3 drive using a moist cloth
- 3 Be sure that you do not damage the drive's connecting cable.

|   |   |
|---|---|
|  | <b>NOTICE</b>   |
|   | Do not use a cleanser that contains benzene, alcohol or similar solvents. |



## 10. Disposal

The DUOMAT 3 drive consists of electronic components, cables and metal and plastic parts. You should observe all corresponding national and regional environmental regulations when disposing of the DUOMAT 3 drive.

The disposal of the end product is regulated in Germany by Elektro-G, internationally by the EU Directive 2012/19/EC (WEEE), or by any applicable national laws and regulations.



The DUOMAT 3 drive should not be disposed of with normal household waste!



The disposal of the nine-volt batteries is regulated in the EU by Battery Directive 2006/66/EC, in Germany by the BattG battery law of 25.6.2009, and internationally by any applicable national laws and regulations.



The nine-volt batteries should not be disposed of with normal household waste!



## Einbauerklärung

nach Anhang II der EU-Maschinenrichtlinie  
2006/42/EG

Der Hersteller

## Declaration of Incorporation

*According to Appendix II of the EU Machinery  
Directive 2006/42/EC*

*The manufacturer:*

DewertOkin GmbH  
Weststraße 1  
32278 Kirchlengern  
Deutschland - Germany

erklärt hiermit, dass nachstehend beschriebene  
unvollständigen Maschinen

*declares that the incomplete machines described  
below*

### DUOMAT 3

die folgenden grundlegenden Anforderungen der  
Richtlinie Maschinen (2006/42/EG) erfüllt:

*complies with the following basic requirements of the  
Machinery Directive (2006/42/EC):*

Abschnitt:

*Sections:*

1.1.3; 1.3.3; 1.3.4; 1.3.7; 1.5.1; 1.5.2; 1.5.5; 1.5.6; 1.5.7; 1.5.8; 1.5.9; 1.5.10; 1.5.13

Die unvollständige Maschine darf erst dann in Be-  
trieb genommen werden, wenn festgestellt wurde,  
dass die Maschine, in die die unvollständige Ma-  
schine eingebaut werden soll, den Bestimmungen  
der Richtlinie Maschinen (2006/42/EG) entspricht.

*You may only operate this incomplete machine after  
you have confirmed that the end product (into which  
this machine will be installed) complies with the  
Machinery Directive 2006/42/EC.*

Der Hersteller verpflichtet sich, die speziellen Unter-  
lagen zur unvollständigen Maschine einzelstaatli-  
chen Stellen auf begründetes Verlangen elektronisch  
zu übermitteln. Die zur Maschine gehörenden  
speziellen technischen Unterlagen nach Anhang VII  
Teil B wurden erstellt.

*On reasonable request, the manufacturer is obliged  
to send the special documentation accompanying the  
partially completed machinery in electronic form to  
the appropriate national institution. The special  
technical documents corresponding to the machine  
have been created according to Appendix VII, part B.*

Für die Zusammenstellung der technischen Unter-  
lagen ist bevollmächtigt: DewertOkin GmbH  
Weststraße 1  
32278 Kirchlengern  
Tel.: 05223 979-0  
Deutschland - Germany

*For preparation of the technical documentation is  
authorized: DewertOkin GmbH  
Weststraße 1  
32278 Kirchlengern  
Tel.: 05223 979-0  
Deutschland - Germany*



Kirchlengern, Germany 25 November 2019

Dr.-Ing. Josef G. Groß  
Geschäftsführer / Managing Director

## EG-Konformitätserklärung

Nach Anhang IV der EMV-Richtlinie 2014/30/EU

Nach Anhang IV der EU-Niederspannungsrichtlinie 2014/35/EU

Nach Anhang VI der RoHS-Richtlinie 2011/65/EU (inkl. Delegierte Richtlinie (EU) 2015/863)

Der Hersteller

## EU Declaration of Conformity

*In compliance with Appendix IV of the EMC-Directive 2014/30/EU*

*In compliance with Appendix IV of the LVD-Directive 2014/35/EU*

*In compliance with Appendix VI of the EU RoHS Directive 2011/65/EU (incl. Commission delegated Directive (EU) 2015/863)*

*The manufacturer*

DewertOkin GmbH  
Weststraße 1  
32278 Kirchlegern  
Deutschland - Germany

erklärt hiermit, dass das Produkt

*declares that the following product*

### DUOMAT 3

die Anforderungen folgender EG-Richtlinien erfüllt:

*meets the requirements of the following EU directives:*

**Richtlinie über elektromagnetische Verträglichkeit 2014/30/EU**

***Electromagnetic Compatibility Directive 2014/30/EU***

**Niederspannungsrichtlinie 2014/35/EU**

***Low Voltage Directive 2014/35/EU***

**DELEGIERTE RICHTLINIE (EU) 2015/863 DER KOMMISSION vom 31. März 2015 zur Änderung von Anhang II der Richtlinie 2011/65/EU des Europäischen Parlaments und des Rates hinsichtlich der Liste der Stoffe, die Beschränkungen unterliegen.**

***COMMISSION DELEGATED DIRECTIVE (EU) 2015/863 of 31 March 2015 amending Annex II to Directive 2011/65/EU of the European Parliament and of the Council as regards the list of restricted substances.***

Angewendete Normen

*Applied standards:*

- EN 60335-1:2012/A11:2014
- EN 55014-1:2006/A1:2009/A2:2011
- EN 55014-2:1997/A1:2001/A2:2008
- EN 61000-3-2:2014
- EN 61000-3-3:2013
- EN 62233:2008

Konstruktive Änderungen, die Auswirkungen auf die in der Montageanleitung angegebenen technischen Daten und den bestimmungsgemäßen Gebrauch haben, das Produkt also wesentlich verändern, machen diese Konformitätserklärung ungültig!

*This declaration of conformity is no longer valid if constructional changes are made which significantly change the drive system (i.e., which influence the technical specifications found in the instructions or the intended use)!*

Kirchlegern, Germany 25 November 2019



Dr.-Ing. Josef G. Groß  
Geschäftsführer / Managing Director

## Additional information

### DUOMAT 3 drive system

The following standards and norms were used in the versions with at least IPX4 – in accordance to EN 60601-1, IEC 60601-1, 3. Edition, EN 60601-2-52, IEC 60601-2-52, Medical electrical equipment – applied:

|                            |   |
|----------------------------|---|
| EN60601-1, Main section 2  | Environmental conditions                        |
| EN60601-1, Main section 3  | Electrical shock protection                     |
| EN60601-1, Section 21      | Mechanical attachment                           |
| EN60601-1, Main section 7  | Overheating protection                          |
| EN60601-1, Main section 9  | Improper operations and malfunctions            |
| EN60601-1, Main section 10 | Structural requirements                         |
| EN60601-1, Section 56.8    | Power supply indicator is, however, not present |
| EN60601-2-38, Section 36   | Electromagnetic compatibility                   |
| EN60601-1-2                | Electromagnetic compatibility                   |

For the care version, in accordance with EN1970:2000, "Beds for disabled persons", the following standards are used:

|                             |   |
|-----------------------------|---|
| EN1970, Section 4 partially | Unintentional movement:<br>Prevention by a locking device (e.g. control box, MEDIX SK CARE or IPROXX®)<br>Lowering the backrest by the use of a battery, or lowering the backrest using a mechanical release control unit with a keypad |
| EN1970, Section 5.5.8       | Dimensions of the control unit  |
| EN1970, Section 5.6         | Operational forces for the electrical functions   |
| EN1970, Section 5.7         | Functional speeds<br>(for adjusting the head and foot sections)   |
| EN1970, Section 5.11        | Electrical requirements of protection degree: only for IPX4   |
| EN1970, Section 5.12        | Electromagnetic compatibility   |

In accordance with EN60601-2-38:1996 +A1:2000 (electrically operated hospital beds), the following standards apply when using the HOSP version:

|                                |  |
|--------------------------------|--|
| EN60601-2-38, Section 5.2      | The classification of application parts  |
| EN60601-2-38, Section 5.3      | System protection category, only for $\geq$ IPX4   |
| EN60601-2-38, Section 22.2.102 | Locking device<br>Control box, Supervisor, or IPROXX <sup>®</sup> SE   |
| EN60601-2-38, Section 22.4.101 | Control unit with button   |
| EN60601-2-38, Section 36       | Electromagnetic compatibility  |
| EN60601-2-38, Section 52.4     | Unintentional movement (locking device)  |
| EN60601-2-38, Section 52.5     | First fault (electrical):<br>Prevented by means of a locking mechanism or IPROXX <sup>®</sup>                                    |
| EN60601-2-38, Section 52.5.9   | Component outages:<br>Prevented by means of a locking device   |
| EN60601-2-38, Section 52.5.101 | Outages of electrical components   |
| EN60601-2-38, Section 52.5.102 | Inclination of the back section and the Trendelenburg during a power outage:<br>Using a battery or by using a mechanical release |
| EN60601-2-38, Section 56.8     | Lighting (not required)  |
| EN60601-2-38, Section 57.3a    | Power cord   |
| EN60601-2-38, Section 57.3.101 | Mains plug   |

In accordance with IEC 60601-2-52:2009, "Particular requirements for the safety and essential performance of medical beds", the following standards are used:

|                                       |  |
|---------------------------------------|--|
| IEC60601-2-52, Section 201.6.2        | Protection against electrical shock: Protection class II   |
| IEC60601-2-52, Section 201.6.3        | Control panel symbols (depending on model, customer requirements)  |
| IEC60601-2-52, Section 201.8.11.3.2   | Power supply lead: only $\geq 2.5$ m length<br>Power supply lead: for example, EPR or similar  |
| IEC60601-2-52, Section 201.9.2.2.5    | Continuous operations: Control unit only with button   |
| IEC60601-2-52, Section 201.9.2.3.1    | Unintentional movement:<br>Prevented by means of a locking mechanism (such as Control box, Supervisor, IPROXX <sup>®</sup> SE, IPROXX <sup>®</sup> , or Meditouch)     |
| IEC60601-2-52, Section 201.9.6.2.1    | Noise level: $\leq 65$ dB(A) (refer to EN60601-2-38)   |
| IEC60601-2-52, Section 201.11.1.1     | Temperatures   |
| IEC60601-2-52, Section 201.11.6.5.101 | Protection against water ingress: only for $\geq$ IPX4   |
| IEC60601-2-52, Section 201.11.8       | Power outage:<br>for example, battery usage, depending on version (customer requirement)   |
| IEC60601-2-52, Section 201.13.1.4     | Special mechanical hazards:<br>Prevented by means of a locking mechanism (such as Control box, Supervisor, IPROXX <sup>®</sup> SE, IPROXX <sup>®</sup> , or Meditouch) |
| IEC60601-2-52, Section 201.15.3.4.1   | Mechanical attachment – handset  |
| IEC60601-2-52, Section 201.15.4.4     | Displays: Ready indicator is not required  |
| IEC60601-2-52, Section 201.17         | Electromagnetic compatibility  |
| IEC60601-2-52, Section BB.3.3.3       | Dimensions: vary according to the model (customer requirement)   |
| IEC60601-2-52, Section BB.3.4.1       | Operating forces   |



**DEWERT OKIN**

A DewertOkin Technology Group Company

DewertOkin GmbH  
Weststraße 1  
32278 Kirchlengern, Germany  
Tel: +49 (0)5223/979-0  
Fax: +49 (0)5223/75182  
<http://www.dewertokin.de>  
[Info@dewertokin.de](mailto:Info@dewertokin.de)

ID-Nr.: 68010