



# **AG300**

## **Installation Instructions**

**(Translation of the original installation instructions)**



# Foreword

## Document revision history

Version	Date	Modification, change
(-)	06/2015	First release

## Disclaimer and exclusion of liability

DewertOkin is not responsible for damage resulting from:

- failure to observe these instructions,
- changes made to this product which have not been approved by DewertOkin, or
- the use of replacement parts which have not been approved or manufactured by DewertOkin.

## Manufacturer's address

DewertOkin GmbH  
Weststrasse 1  
32278 Kirchlengern, Germany  
Germany  
Tel: +49(0)5223/979-0  
Fax.: +49 0 522375182  
<http://www.dewertokin.de>  
[Info@dewertokin.de](mailto:Info@dewertokin.de)

## Creation of a complete operating instruction manual for the entire end product

These instructions are only intended to be used by the end-product manufacturer. They should not be given to the operator of the end product. The factual information contained within may be used as a basis when creating the end-product manual.

The warning and danger notices are best suited for use in the end product's manual. However, it is not sufficient to simply follow these notices. You should also carry out an internal risk assessment for your end product. This can then be used as the basis for the safety notices in your manual.

## Usage in medical products

The AG300 is not a medical device. If used in a medical end product, you (the end manufacturer) are obliged to ensure compliance with EC directives and to ensure that other pertinent medical product regulations are maintained.

## Notice for customers in EU nations

### German Inspection Authority (TÜV SÜD Product Service) testing label

The construction of the AG300 has been inspected by the German TÜV SÜD Product Service Inspection Authority. TÜV SÜD Product Service also monitors the production of the AG300. The official German TÜV SÜD Product Service certifies this construction inspection and production monitoring.

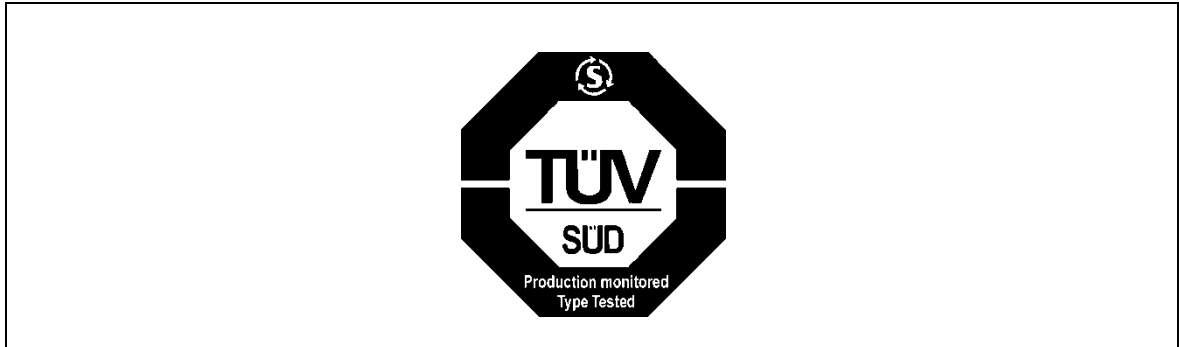

Figure 1 TÜV SÜD Product Service Safety Mark

# Table of contents

<b>Foreword</b>	<b>3</b>
Document revision history	3
Disclaimer and exclusion of liability	3
Manufacturer's address	3
Creation of a complete operating instruction manual for the entire end product	3
Usage in medical products	3
Notice for customers in EU nations	4
<b>Table of contents</b>	<b>5</b>
<b>1. General Information</b>	<b>7</b>
1.1 About these installation instructions	7
1.2 Availability of this document	7
1.3 Conventions used	7
<b>2. Safety notices</b>	<b>8</b>
2.1 Proper and intended usage	8
2.2 Selection and qualification of personnel	9
2.3 Notice on safety during operations	10
2.4 Product labelling	11
<b>3. Possible combinations</b>	<b>12</b>
<b>4. Description</b>	<b>13</b>
4.1 Components	13
<b>5. Technical specifications</b>	<b>14</b>
<b>6. Installation</b>	<b>16</b>
6.1 Safety notices to observe during installation	16
6.2 Installation procedure	17
<b>7. Operating notes</b>	<b>22</b>
7.1 General information	22
7.2 Information about commissioning the AG300	24
7.3 Safety instructions for operating and charging the AG300	24
7.4 Notices for operating and charging the AG300	24
7.5 Charging the AG300	25
7.6 Charging display on the handset (examples)	26
81423(-)	5



<b>8.</b>	<b>Troubleshooting</b>	<b>27</b>
<b>9.</b>	<b>Maintenance</b>	<b>28</b>
9.1	Maintenance	28
9.2	Cleaning and care	28
9.3	Note on maintenance and care	29
<b>10.</b>	<b>Disposal</b>	<b>30</b>
10.1	Packaging material	30
10.2	Components of the AG300	30
10.3	Batteries	30
	<b>EU Declaration of Conformity</b>	<b>31</b>

# 1. General Information

## 1.1 About these installation instructions

These installation instructions must be followed closely in order to install the AG300 successfully and safely. These instructions are not an operating manual for the end product.

These instructions will help you to minimize danger, repair costs and down times. They will also help you to maximize the reliability and lifespan of the end product.

 <b>CAUTION</b>
 <p>The notices in these instructions must be followed! Following the guidelines during installation and connection procedures will help to minimize:</p> <ul style="list-style-type: none"> <li>• the risk of accident and injury, and</li> <li>• damage to the AG300 or the end product.</li> </ul>

These installation instructions have been written with due care and attention. However, we cannot guarantee that the data, images and drawings are complete and correct nor do we accept any liability for the information contained therein, unless required by law.

- ▶ We reserve the right to make unannounced technical changes in the course of our continual product improvement process!

## 1.2 Availability of this document



As manufacturer of the end product, you are obligated to comply with Machinery Directive 2006/42/EC. This directive stipulates that the installation instructions must be kept on file for governmental inspection purposes.



## 1.3 Conventions used

Notices which do not relate to safety are indicated in these instructions with a symbol:

- ▶ Triangular notice symbol

### Explanations of warning notices

 <b>CAUTION</b>
 <p>CAUTION indicates a hazardous situation which, if not avoided, could result in minor or moderate injury.</p>



 <b>NOTICE</b>
 <p>NOTICE is used to address practices which are not related to personal injury but may result in damage to the product or surroundings.</p>

## 2. Safety notices

### 2.1 Proper and intended usage



The AG300 is intended to be used as an independent power supply for suitable DewertOkin drive systems:



- for care purposes,
- or in hospitals.

	 <b>CAUTION</b>
	<p>The AG300 should only be used for the applications described above. Any other use is forbidden. Improper usage can lead to accidents or destruction of the unit. Such non-approved applications will lead immediately to the expiration of all guarantee and warranty claims on the part of the end-product manufacturer against the manufacturer.</p>

#### 2.1.1 Improper usage

Be sure to follow the notices below concerning improper usage. You should include them in your product manual in order to inform the users of your end product.

	 <b>CAUTION</b>
	<p>The AG300 should not be used:</p> <ul style="list-style-type: none"> <li>• in any environment where combustible or explosive gases or vapours (e.g., anaesthesiology) may be present,</li> <li>• in the proximity of open fires or other heat sources (such as furnaces, ovens or direct sunlight),</li> <li>• as a power source for toys or games,</li> <li>• in any application that will be cleaned with an automated washing system,</li> <li>• in a moist environment, or</li> <li>• outdoors.</li> </ul>

	 <b>CAUTION</b>
	<p>The AG300 may not be operated:</p> <ul style="list-style-type: none"> <li>• by small children,</li> <li>• by frail or infirm persons without supervision, or</li> <li>• in the proximity of small children.</li> </ul>



The AG300 can be used by children of 8 years and older, persons with reduced physical, sensory or mental capabilities, or persons with lack of experience or knowledge when they are supervised or instructed concerning the safe use of the device and when they understand the resulting risks. Do not allow children to play with this device. The cleaning and user maintenance must not be carried out by children without supervision.

- ▶ You should only use spare parts which have been manufactured or approved by DewertOkin. Only these parts will guarantee a sufficient level of safety.



### Battery-operated reset function

The AG300 has a battery-operated reset function.

	 <b>CAUTION</b>
The battery-operated reset function is not a safety system and does not avert danger.	

DewertOkin does not guarantee that the drive will function in the event of a power outage.

If the end-product manufacturer chooses to guarantee the functionality of the end product during a power outage, then the end-product manufacturer is responsible for arranging a mechanism to ensure this functionality.

### Using the drive systems in medical applications

This DewertOkin product complies with the safety requirements found in IEC 60601-1.

We strongly recommend that the end product (including all its components) which you are manufacturing for a medical application should also comply with the safety requirements found in IEC 60601-1.

You should make sure that the mechanical movement of the motor in your end product poses no risk of injury. Conduct a risk analysis for the end product for this purpose. You should also include safety notices in the instructions for the end product and technical safeguards in your product to eliminate any risk.

## 2.2 Selection and qualification of personnel

The AG300 should only be installed into the end product by someone who has completed training in electronic motor assembly or has equivalent qualifications.

You should only install the AG300 control system when you are qualified to do so. Otherwise, a properly qualified person should be found for this task.

### 2.3 Notice on safety during operations

Basic safety rules must be followed in order to ensure that the end product can be continually operated in a safe manner. These rules must be observed while using the end product and while installing the AG300 in the end product.



These rules and safety measures can be categorized as follows:

- Construction measures before the installation (refer to the "Ensuring operational reliability during installation" section in the "Installation" Chapter).
- Safety fundamentals during the AG300 installation and during cable and wire routing (refer to the "Electrical connection" section in the "Installation" Chapter).
- Basic safety rules during operation (refer to the "Operating notes" Chapter).
- The creation of a manual for the end product which contains these and other safety rules.

#### 2.3.1 Creating a user's manual



The manufacturer of the end product must create a manual for the users of that product. The safety notices in the end-product manual must be written based on the end product's risk assessment.

#### 2.3.2 Electrical safety

	 <b>CAUTION</b>
	<p>Be careful; there is a risk of electrical shock! Be sure to unplug the power cord on the drive before you begin installation! Make sure that the mains plug is accessible at all times.</p>

- ▶ Do not open the AG300! Faulty or defective units may be sent to your supplier/dealer for repairs.

#### 2.3.3 Shutting down the connected drive in case of emergency

	 <b>CAUTION</b>
	<p>An emergency stop can be achieved by pulling the connecting plug from the AG300 out of the drive or the control unit. This power cable must be accessible at all times during operation so that the cable can be unplugged.</p>

## 2.4 Product labelling

### 2.4.1 Ratings plate (type label)

A ratings plate on each AG300 specifies the exact name and serial number. It also states the technical specifications valid for that particular AG300. The following illustrations show where the specifications are located on the ratings plate of the AG300.

- ▶ The ratings plate shown is an example; The specifications for the AG300 may differ from this illustration.

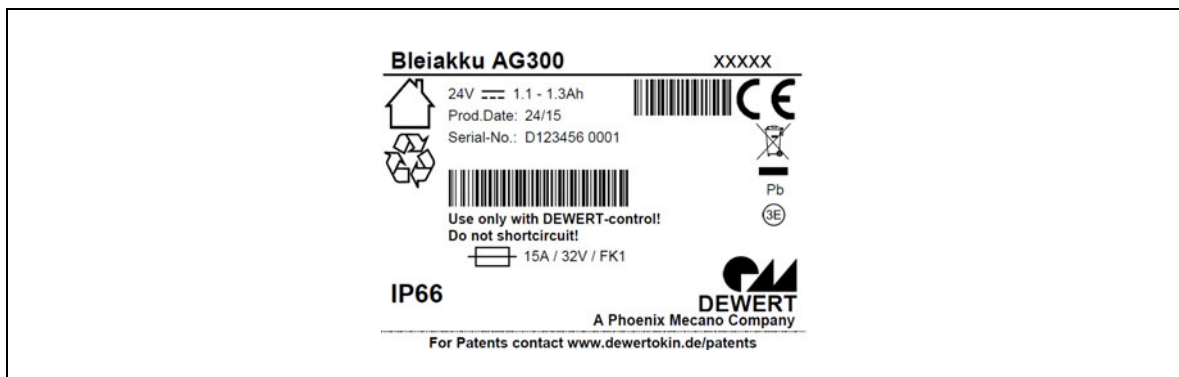







Figure 2 AG300 ratings plate example

Lead battery AG 300	Type designations
xxxxx	Article number
24V ~	Input voltage
1.1 – 1.3 Ah	Electrical charge
Prod.date	Calendar week / year
Serial No.	Serial number
IP66	Protection degree
	Use in dry rooms only!
	Fuse
15 A / 32 V / FK1	Description of the fuse
 Pb	Follow all special disposal instructions!
	Determine labelling
	Conformity mark
	Follow the special disposal instructions for recycling!

### 3. Possible combinations

The AG300 can be combined with various components. The following basic combinations are possible:

- An AG300 connected to a DUOMED,
- An AG300 connected to a SGAG300.

Systems can be customized by combining the drive, control unit, AG300 and handset.

DewertOkin has separate system instruction manuals containing the additional information and instructions needed for these systems. You can also find more information at [www.dewertokin.de](http://www.dewertokin.de).

## 4. Description

The AG300 lead battery is used as an emergency power supply for one or more DewertOkin drives. The AG300 can be charged in the following ways:

- using a charging circuit in the drive or in the control unit,
  - using an external charging station,
- ▶ We reserve the right to make unannounced technical changes in the course of our continual product improvement process!

### 4.1 Components

The AG300 is a compact lead-acid battery that should be connected to DewertOkin drives and control units. The AG300 is mounted either on the drive, control unit or in a mounting plate.

- ▶ A charging station is available for the AG300; four AG300 batteries can be charged simultaneously in this station.

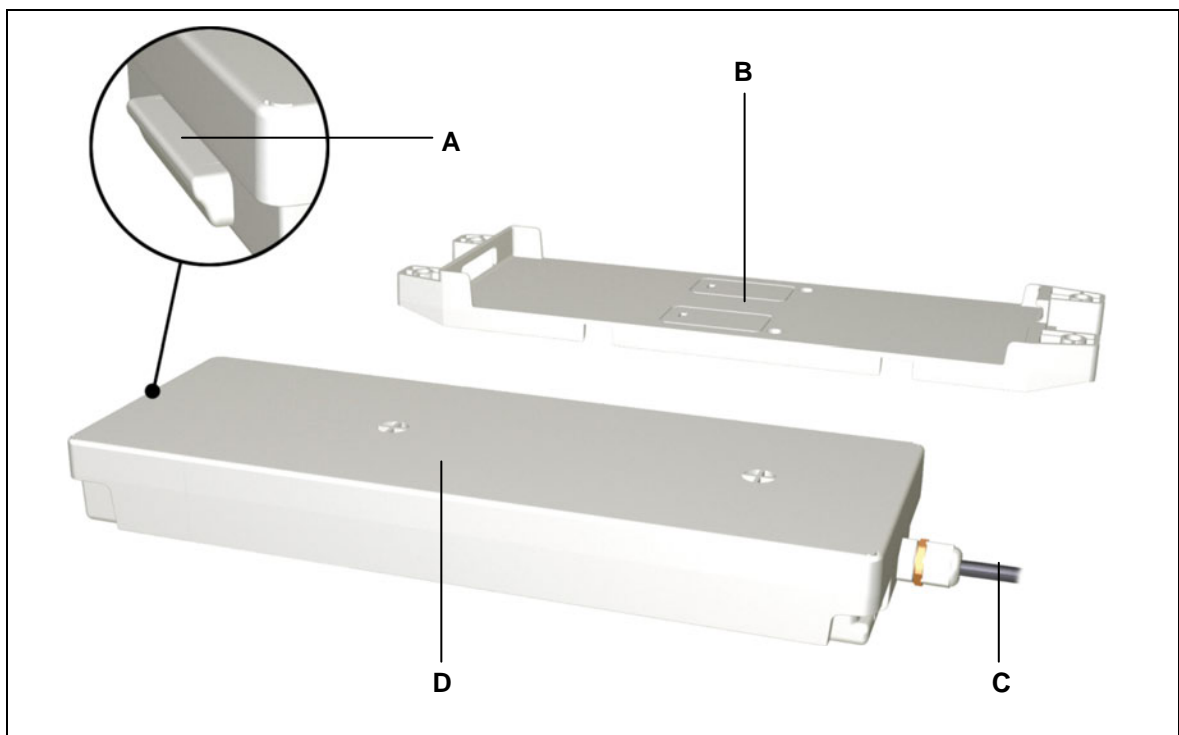

Figure 3 Components for the AG300

- |   |                             |
|---|-----------------------------|
| <b>A</b> Locking clip for attachment on the mounting plate, DUOMED or SGAG300 | <b>B</b> Mounting plate     |
| <b>C</b> Cable for connecting to drive or control unit                        | <b>D</b> AG300 lead battery |

## 5. Technical specifications

<b>AG300</b>	
Rated voltage	24 V DC
Capacity	1.1 – 1.3 Ah
Fuse	T 15 A
Protection degree	IPX4, IP44, IPX6, IP66
Battery type	Lead fleece
Final charging voltage	26.5 V – 29.0 V DC (depending on the control unit)
Charging time	Approx. 14 hours (depending on the control unit)
Lifespan	Approx. 1000 charging cycles (depending on the battery care <sup>1</sup> and your application)
Self-discharging	After approx. 6 months
<b>Dimensions and weight</b>	
Length x width x height	305 mm x 110 mm x 34 mm
Weight	Approx. 1.5 kg
<b>Ambient conditions for operation, storage and transport</b>	
Transport / storage temperature	From -20 °C to +50 °C From -4 °F to +122 °F
Operating temperature	From +10 °C to +40 °C From +50 °F to +104 °F
Relative humidity	From 30 % to 75 %
Air pressure	From 800 hPa to 1060 hPa
Height	< 2000 m

<sup>1</sup> Refer to section 10.2.



Figure 4 Dimensions of the AG300, top view (in mm)

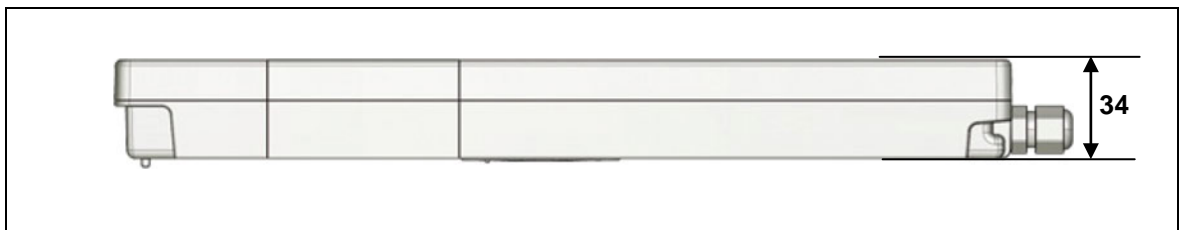



Figure 5 Dimensions of the AG300, side view (in mm)

## 6. Installation

### 6.1 Safety notices to observe during installation

Basic safety rules must be followed in order to ensure that the end product can be continually operated in a safe manner. These rules must be observed while using the end product and while installing the AG300 in the end product.

#### 6.1.1 Pause times for the AG300

NOTICE	
	<p>The following pause times for the AG300 must be observed. The unit must not be in operation for at least 1 hour:</p> <ul style="list-style-type: none"><li>• before commissioning,</li><li>• before removal and</li><li>• before changing the battery.</li></ul>

#### 6.1.2 Avoiding electrical faults

The AG300 has a connecting cable. When sizing your end product, remember that the connecting cable must never be squashed (e.g. by moving over it) during operations.

#### 6.1.3 Ensuring operational reliability during installation

The safety and reliability of the end product containing DewertOkin components can be ensured by using the proper construction methods described below.



## 6.2 Installation procedure

Before installing and connecting the AG300, make sure that you are observing all of the safety notices found in the "Safety notices to observe during installation" section.

- The AG300 can be inserted into the holder on the DUOMED or SGAG300.
- The AG300 can be inserted into the mounting plate that is attached to the end product.

### 6.2.1 Mounting the AG300 to the DUOMED

	<b>⚠ CAUTION</b>
	Work on electrical components should be conducted only when the mains power connection is unplugged.

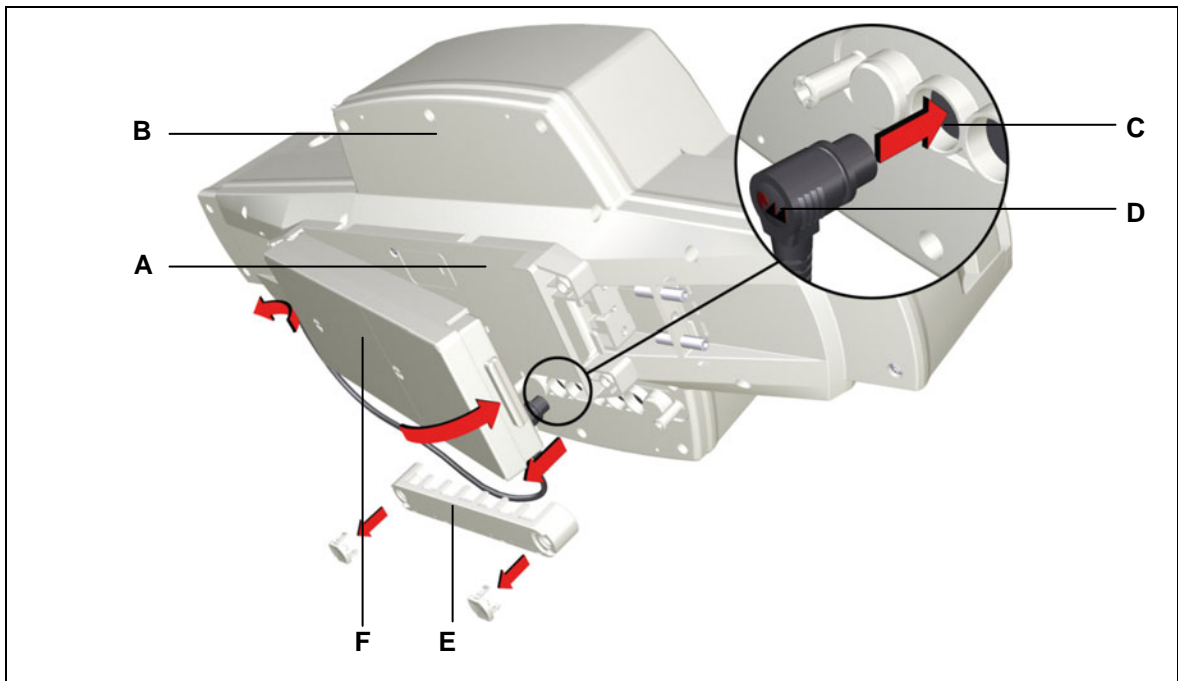



Figure 6 Mounting the AG300 to the DUOMED drive

- |                                      |  |
|--------------------------------------|--|
| <b>A</b> Holder on the drive         | <b>B</b> DUOMED                              |
| <b>C</b> Battery socket on the drive | <b>D</b> Plug for the AG300 connecting cable |
| <b>E</b> cap                         | <b>F</b> AG300                               |

Take the following steps when installing the AG300 in the DUOMED:

- 1 First, insert the battery (**F**) in the slots on the left side of the holder (**A**) until the AG300's locking clips engage.
- 2 Then snap in the locking clip on the right side of the battery into the right slot on the holder (**A**).
- 3 Remove the drive's cap (**E**) and the dummy plug from the battery socket (**C**) (if present). Then connect the AG300 cable (**D**) to the battery socket (**C**).
- 4 Then place the cap (**E**) back on and secure it.

### 6.2.2 Connecting the AG300 to the SGAG300 control unit

	<p><b>⚠ CAUTION</b></p>
<p>Work on electrical components should be conducted only when the mains power connection is unplugged.</p>	

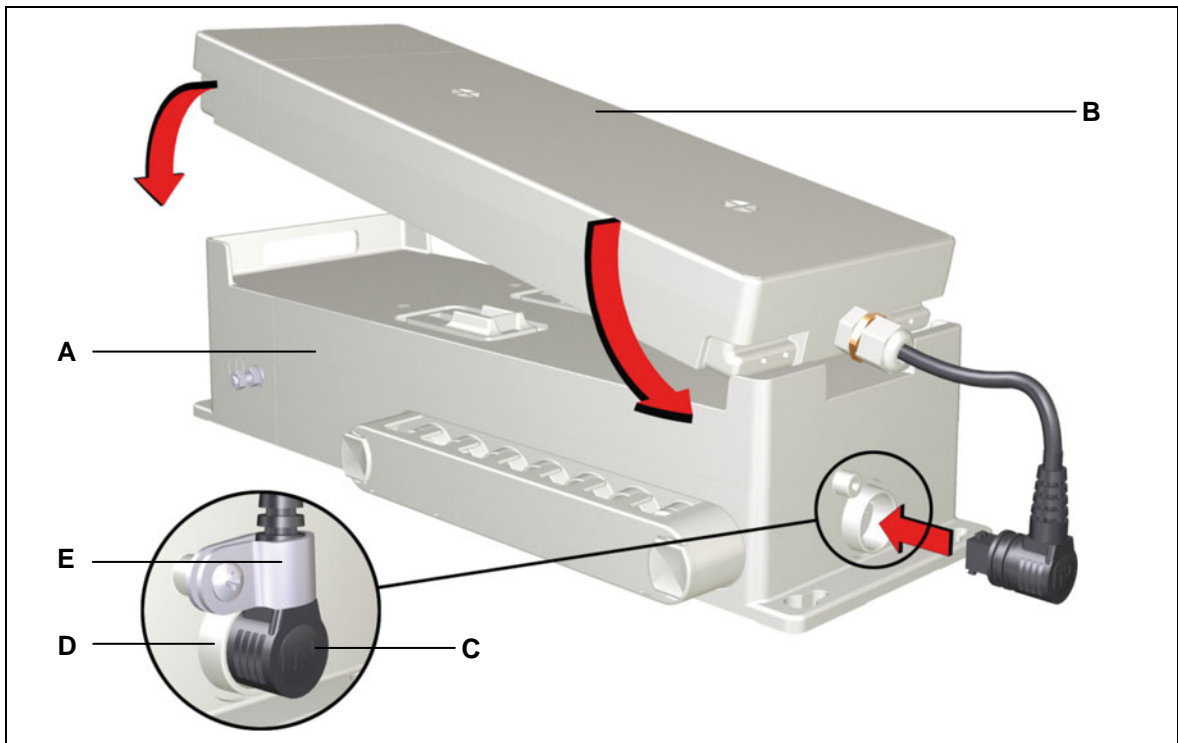

Figure 7 Connecting the AG300 to the SGAG300 control unit



- |  |                         |
|--|-------------------------|
| <b>A</b> SGAG300                             | <b>B</b> AG300          |
| <b>C</b> Plug for the AG300 connecting cable | <b>D</b> Battery socket |
| <b>E</b> Strain relief mechanism             |                         |

Take the following steps to connect the AG300 to the SGAG300 control unit:

- 1 First, insert the battery (**B**) in the slots on the right side of the control unit (**A**) until the AG300's locking clips engage.
- 2 Then snap in the locking clip on the left side of the battery into the left slot on the SGAG300 (**A**).
- 3 Connect the AG300 cable (**C**) to the battery socket on the SGAG300 (**D**).
- 4 Then place the strain relief mechanism (**E**) on the plug and screw it gently in.

### 6.2.3 Mounting the AG300 to the end product

Six screws should be used at the six mounting points to attach the AG300 mounting plate to the end product. The mounting plate should be mounted so that it lies flat against its supporting base. In the end product, no mechanical forces (such as torsion) should be put on the mounting plate or the AG300. Such forces could lead to damage (such as cracks) in the housing.

	 <b>CAUTION</b>
	<p>Work on electrical components should be conducted only when the mains power connection is unplugged.</p>

	<b>NOTICE</b>
	<p>The following information is important when mounting the AG300:</p> <ul style="list-style-type: none"> <li>• Charge the AG300 completely (for at least 24 hours) before first use. The installed batteries achieve their full capacity only after 5 to 10 discharge cycles.</li> <li>• The air vents on the AG300 must <b>not</b> be covered during the charging process.</li> <li>• When mounting the AG300, make sure that it is <b>not</b> lying on its top (upside down) and the connecting cable is <b>not</b> facing downwards. The AG300 may only be charged when it is properly positioned (as shown in Figure 11).</li> <li>• Allow the AG300 to rest for about 1 hour after charging it; this will prolong its life-span.</li> </ul>

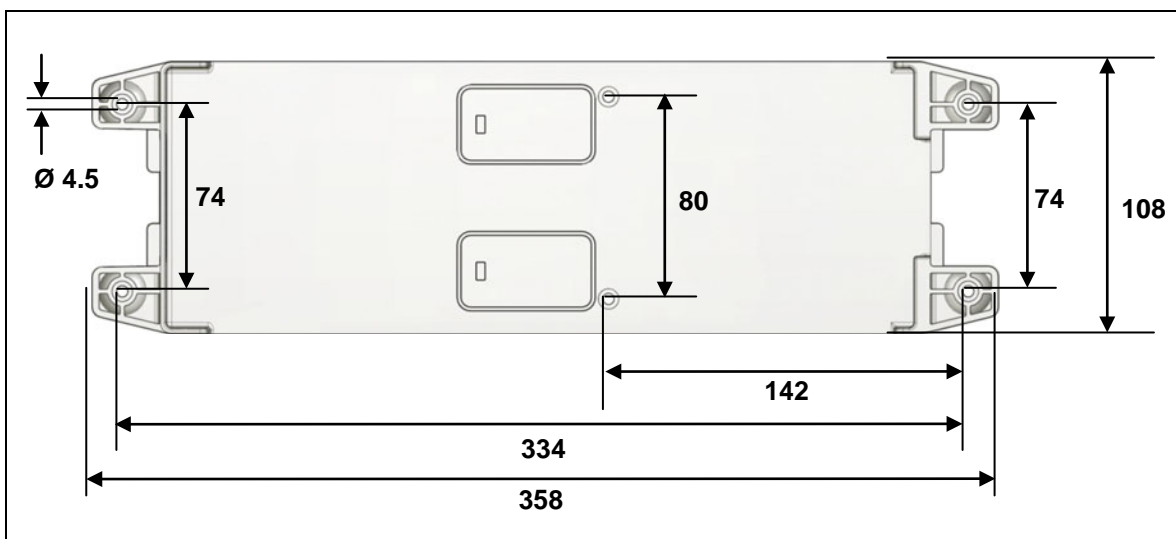

Figure 8 Mounting points on the AG300 mounting plate (specifications in mm)

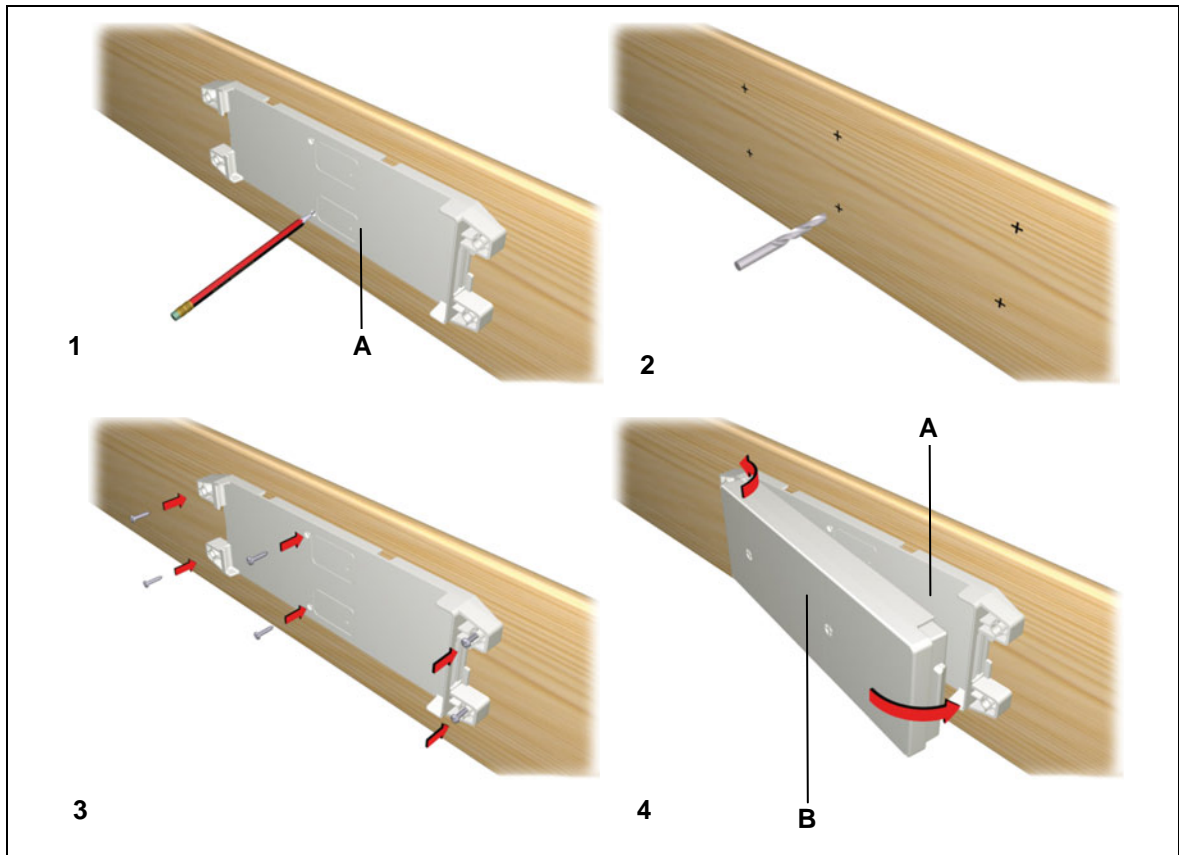

Figure 9 Attaching the mounting plate and inserting the AG300

**A** Mounting plate

**B** AG300

Proceed as follows to install and attach the mounting plate to the AG300:

- 1 Mark the positions of the mounting points on your end product.
- 2 Drill out the mounting points.
- 3 Screw the mounting plate (**A**) into position using the six mounting points. Use suitable screws (e.g. ISO 7049 ST3.5 x 25) to attach it to your end product. Make sure that the mounting plate lies completely flat against its supporting base. This will prevent mechanical forces such as torsion.
- 4 Place the battery in the lower part of the mounting plate (**A**). Then push the battery into the upper part until the tabs on the battery snap in.
- 5 You may now connect the battery cable to the battery socket on the drive or control unit.

## 6.2.4 Electrical connection



### Routing the electrical cables

When routing the cables, be sure that:

- the cables cannot get jammed,
- no mechanical load (such as pulling, pushing or bending) will be put on the cables, and
- the cables cannot be damaged in any way.

Fasten all cables (especially the connecting cables) to the end product using sufficient kink prevention methods. Be sure that the design of the end product prevents the connecting cables from coming into contact with the floor during transport.



## 6.2.5 Removing the AG300

	 <b>CAUTION</b>
	You should only connect and disconnect the cables when they are completely disconnected from any live current!

- 1 First, remove all strain relief and caps from the AG300 connection. Then disconnect the battery plug from the socket on the drive or control unit.
- 2 Take the battery out of the drive's holder or from the end product. You will need to press the battery's locking clip in until the battery can be pulled out of the compartment.
- 3 Insert the dummy plug (if available) for the battery socket on the drive or control unit.
- 4 Put the cap over the connection on the drive or control unit. Then secure the cap in place.



## 7. Operating notes

The factual information contained within may be used when you are creating the end-product manual. The installation instructions do not contain all information required for the safe operation of the end product. They only describe the assembly and operation of the AG300 as a partially assembled piece of machinery.

	 <b>CAUTION</b>
	When creating the operating instructions, remember that the installation instructions are intended for qualified specialists and are not for typical users of the end product.



### 7.1 General information

- ▶ Only components that have been approved from DewertOkin should be connected to the AG300; only approved components have been verified to work together. Ask your customer representative for more information.



	 <b>CAUTION</b>
	The connecting cable for the AG300 must remain easily accessible during all operating situations!

#### Inspecting before the initial commissioning and after external impacts

Heavy mechanical impacts (which may occur during transport or by dropped objects) can sometimes result in electrical malfunctions.

	 <b>CAUTION</b>
	<p>In order to improve the operational reliability, take the following steps before the initial commissioning and after any extreme mechanical loads:</p> <p>Check if the housing is damaged. If the housing shows signs of damage or if the device heats up excessively,</p> <ul style="list-style-type: none"> <li>• Unplug the AG300 from the drive or control unit and take the drive system out of service.</li> </ul>

#### Avoiding electrical risks

	 <b>CAUTION</b>
	Make sure that no live (current-carrying) parts of the drive system and power supply can be touched. In particular, be sure that unused power and control unit connections are covered adequately.



### Deep-discharge protection

The drive system is completely deactivated whenever the voltage of the AG300 has reached the shutdown threshold level. This deep discharge monitor protects the rechargeable battery from damages that could result when the discharge warning is ignored.

► Observe the following when operating under battery power:



- An acoustic warning signal will sound when the voltage of the AG300 falls to its deep-discharge protection level. The battery should be charged immediately when you hear this warning signal. However, it will still be possible to move the drive for a short time.
- If this deep-discharge warning is ignored, the drive system will shut down completely in the second stage in order to prevent damages that could occur from a deep discharge.
- Optionally available: deep-discharge protection against the slow discharge that occurs during standby mode. The battery will be completely deactivated if the charge is below the deep discharge threshold for more than 20 minutes. Movements are no longer possible. The battery must be fully re-charged.

### Shutting down the connected drive in case of emergency

 <b>CAUTION</b>

An emergency stop of the control unit can be achieved by pulling the connecting plug from the AG300 out of the drive or the control unit. This power cable must be accessible at all times during operation so that the cable can be unplugged.

### Avoiding cable damage

Be sure that your operating instructions inform the user about the possible cable risks.

 <b>CAUTION</b>

The cables (particularly the connecting cable) should not be run over. In order to prevent injuries or damage to the AG300, no mechanical strain should be placed on the cables.

## 7.2 Information about commissioning the AG300

- Connect the AG300 with the drive or control unit as described in section 7.2.
- Charge the AG300 completely (for at least 24 hours) before first use. The installed batteries achieve their full capacity only after 5 to 10 charge/discharge cycles.

## 7.3 Safety instructions for operating and charging the AG300

- Depending on your model, the AG300 may either be automatically charged using the electronics in the control unit or drive system, or using the charging station (sold separately), as shown in Figure 10.
- As long as the control unit or drive system is supplied with the mains voltage, the automatic charging circuitry ensures that the battery will always be ready.
- After the battery is used to operate the drive system, the lead battery should be immediately recharged (by restoring the connection to mains power).
- The drives may be moved at the same time that the AG300 is being charged.
- The charge level of the AG300 is signalled by an indicator light in the handset (as described in section 8.6).

## 7.4 Notices for operating and charging the AG300

- Do not open or destroy the AG300.
- Charge the AG300 only in its permitted charging position (as shown in Figure 11).
- Do not expose the AG300 to heat or to an open flame. Avoid storage in direct sunlight.
- If the batteries leak and you contact the leaked fluid, wash with plenty of water and seek medical attention immediately.
- Only use the AG300 for its originally intended purpose.
- Do not store the AG300 within reach of children.
- Do not throw the AG300 into fire or open it. Do not solder or weld on the AG300.
- Follow the applicable law and regulations governing the disposal of rechargeable batteries. Batteries may not be disposed with household waste.

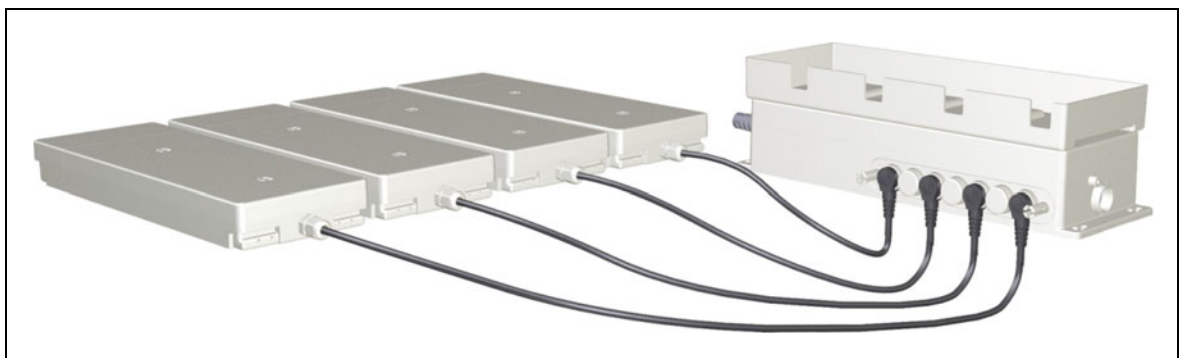



Figure 10 Charging the AG300 at a charging station (charging station sold separately)



## 7.5 Charging the AG300

The AG300 is charged by the drive or control unit that it is connected to. It is also possible to use an external charging station to charge the AG300 (as shown in Figure 10).

<b>NOTICE</b>	
	<p>The AG300 should only be charged by drives or control units from DewertOkin since they have already been verified to work together. The AG300 may also be charged with a DewertOkin charging station.</p> <p>Note the following information when charging:</p> <ul style="list-style-type: none"> <li>• Charge the AG300 completely (for at least 24 hours) before first use. The installed batteries achieve their full capacity only after 5 to 10 discharge cycles.</li> <li>• Refer to Figure 11 for the permitted charging positions.</li> <li>• Allow the AG300 to rest for about 1 hour after charging it; this will prolong its life-span.</li> </ul>

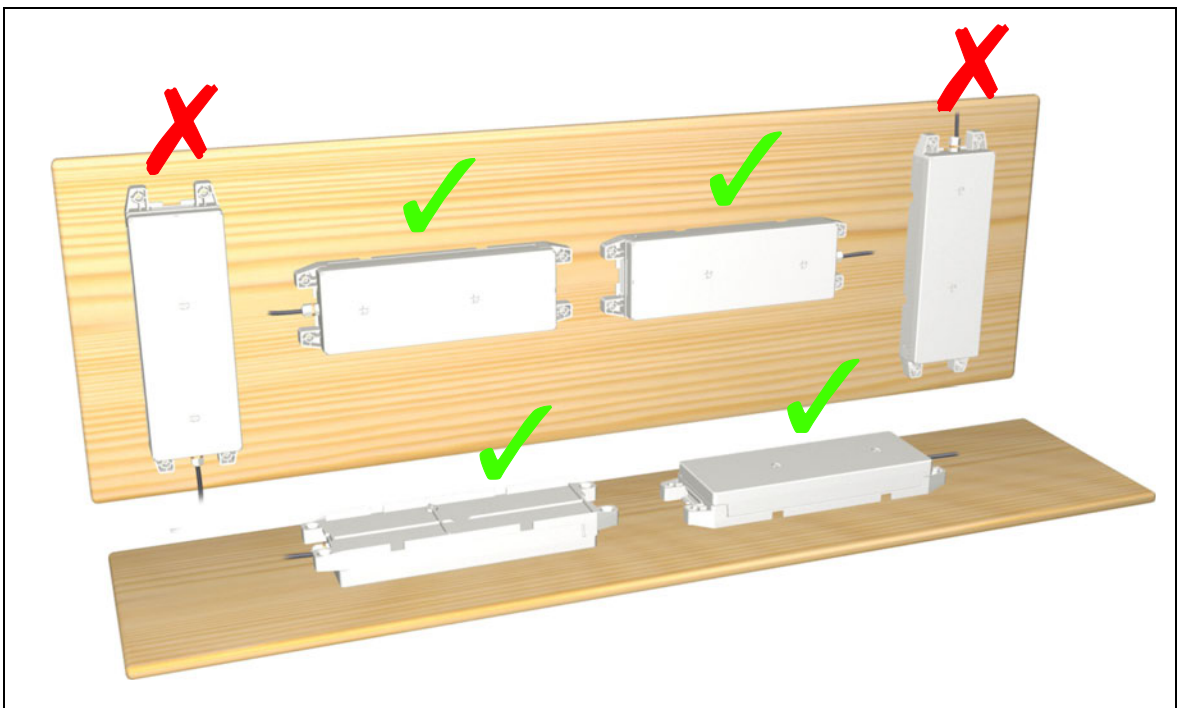

Figure 11 Permitted and prohibited positions when charging the AG300

### 7.6 Charging display on the handset (examples)

Custom handsets can be delivered for use with the AG300. The charging status is indicated by the Power On LED. Two examples are shown below.

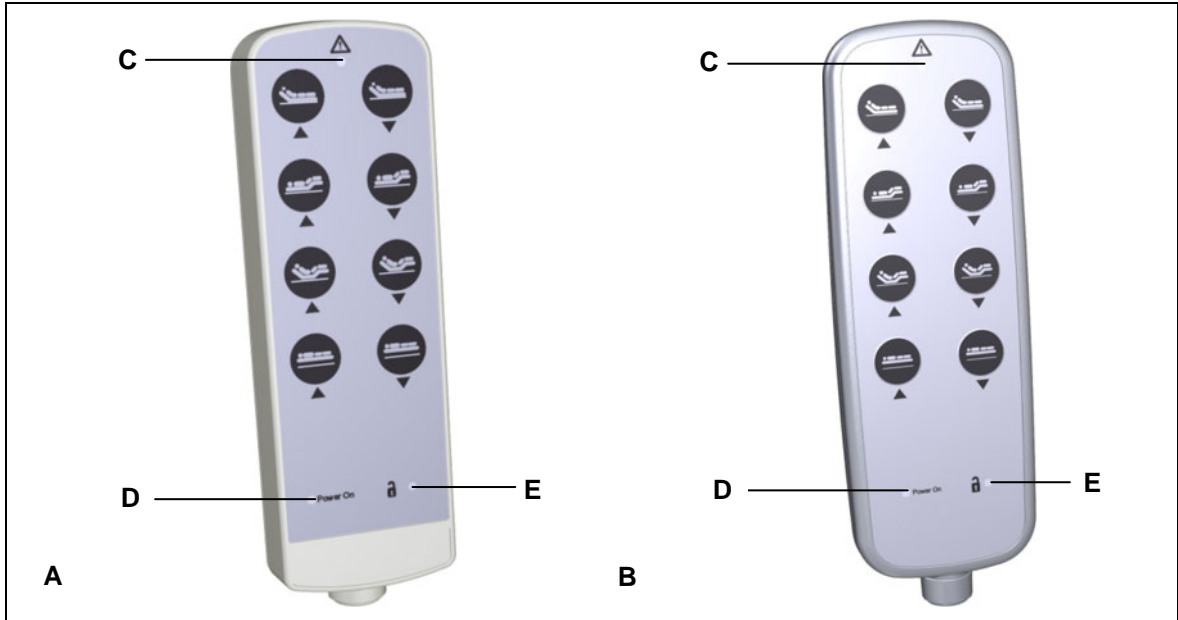

Figure 12 The IPROXX<sup>®</sup> SE and IPROXX 2 handsets (examples)

**A** IPROXX<sup>®</sup> SE handset

**B** IPROXX 2 handset

**C** Function LED

**D** Power On LED (Battery LED)



**E** Status LED

Charge level indicator	Explanation of the charging states
Power On LED is flashing	The battery is charging
The Power On LED is continuously illuminated while connected to mains power.	The battery is charged.

	<b>NOTICE</b>
	<p>The following pause times for the AG300 must be observed. The unit must not be in operation for at least 1 hour:</p> <ul style="list-style-type: none"> <li>before commissioning,</li> <li>before removal and</li> <li>before changing the battery.</li> </ul>

## 8. Troubleshooting

This chapter describes troubleshooting methods for fixing problems. If you experience an error that is not listed in this table, please contact your supplier.

	 <b>CAUTION</b>
	<p>Only qualified specialists who have received electrician training should carry out troubleshooting and repairs.</p>

Problem	Possible cause	Solution
The drive, handset or control unit is not functioning.	The drive, handset or control unit is defective.	Please contact your supplier or sales agent.
	There is no battery voltage.	Make sure the AG300 is connected.
		Make sure the AG300 is fully charged.
The drive is suddenly not capable of movement.	The overheating protection or system protection has been triggered.	Remove the overload (change or remove the load). Remove the power plug and allow the system to rest for 20 to 30 minutes. If this does not resolve the problem, contact your supplier or distributor.
	The unit's fuse may have been triggered.	Please contact your supplier or sales agent.
	A cable has been disconnected (to a drive or control keypad).	Check the cables and contacts and reinsert them, if required.
	The deep-deep-discharge protection mechanism may have triggered.	Make sure the AG300 is fully charged.
The Power On LED on the handset is not illuminated.	There is no mains supply voltage.	Connect the mains power.
	The battery is discharged	Connect the AG300 for charging
The Power On LED on the handset is flashing	The battery is charging	There is no error.
The battery-operated reset function of the drive/controller is not working.	The rechargeable battery is empty.	Charge the battery.
	The battery is not connected.	Connect the battery.
	The battery is defective.	Connect a new battery and dispose of the defective battery properly (refer to the Chapter 11 "Disposal").

## 9. Maintenance

- ▶ You should only use spare parts which have been manufactured or approved by DewertOkin. Only these parts will guarantee a sufficient level of safety.

### 9.1 Maintenance

Type of check	Explanation	Time interval
Check the function and safety of the electrical system.	A qualified electrician should carry out this inspection. (Refer to the "Electrical connection" section in the "Installation" Chapter.)	Periodic inspections can be carried out at intervals based on the risk assessment which you conduct for your end product.
Look over the housing periodically for any signs of damage.	Check the housing for breaks or cracks.	At least every six months.
Look over the plug-in connections and electrical access points for signs of damage.	Check that all electrical cables and connections are firmly seated and correctly positioned.	At least every six months.
Look over the cables for any signs of damage.	Check the connecting cables for pinching or shearing. Also, check the strain relief and kink protection mechanisms, in particular after any mechanical load.	At least every six months.

### 9.2 Cleaning and care

The AG300 is easy to clean. Its smooth surfaces simplify the cleaning process.

	<b>NOTICE</b>
	<p>Never clean the AG300 in an automated washing system or with a high-pressure cleaner. Do not allow fluids to penetrate the unit. Damage to the system could result.</p> <p>Do not use a cleanser that contains benzene, alcohol or similar solvents.</p>

- 1 Be sure to unplug the drive cable on the AG300 before you begin cleaning it!
- 2 Clean the AG300 with a moist cloth.
- 3 Be sure that you do not damage the connecting cables during the cleaning.

## 9.3 Note on maintenance and care

### 9.3.1 Maintenance information

- Plastic surfaces (such as the housing surface) should only be cleaned with a damp cloth.
- Charge the AG300 before you use it. Always use a control unit or drive from DewertOkin that has an integrated charging circuit for charging the battery. A DewertOkin charging station may also be used.
- After the unit has been in storage for a long time, it may be necessary to charge the battery more than once before the complete capacity is restored.
- There are numerous drive systems (especially CARE and HOSP) where a small current will flow even when the drive is not in use. Thus, the AG300 can discharge even when it is not used.
- The storage time should not be longer than six months at the recommended storage temperature. The battery should be charged again after this interval. At higher storage temperatures, the battery should be recharged more frequently. This will help to prevent a complete discharge of the battery, which would damage it irreparably.

### 9.3.2 Care instructions

The lead-acid batteries are maintenance-free. As with any rechargeable battery, the lifespan of the AG300 is limited. The actual lifespan is very dependent on the battery maintenance. In order to achieve the maximum lifespan for the battery, observe the battery level indicator and charge the batteries after any prolonged storage time (6 months storage should not be exceeded).

- Always keep the AG300 clean and dry. Do not short-circuit the AG300. Store the AG300 so that the terminals cannot be shorted to each other or other metallic objects.
- The AG300 should not be exposed to mechanical vibrations.
- Only use the recommended charger.
- Do not use organic solvents (thinning solvents, alcohol, oil, rust inhibitors or surface-active agents such as chemical cleaners, etc.) on the AG300.
- Retain the original documents for any future inquiries.
- The best battery capacity for the AG300 is achieved when the product is used at normal room temperatures (from 20 °C to 25 °C).
- Do not submerge the AG300 in water or store it in a humid location. It should be kept in a cool, dry place. The recommended temperature range for long-term storage is between +10 °C and +30 °C, at a relative humidity of 50 %.
- Only use the AG300 for its specified purpose.

## 10. Disposal

### 10.1 Packaging material

The packaging material should be sorted into recyclable components and then disposed of in accordance with the appropriate national environmental regulations (in Germany according to the recycling law KrWG from 01.06.2012; internationally according to the EU Directive 2008/98/EC (Waste Framework Directive WFD as of 12.12.2008)).

### 10.2 Components of the AG300

The AG300 consists of electronic components, cables and metal and plastic parts. You should observe all corresponding national and regional environmental regulations when disposing of the AG300.

The disposal of the end product is regulated in Germany by Elektro-G, internationally by the EU Directive 2012/19/EC (WEEE), or by any applicable national laws and regulations.



The AG300 components should not be disposed of with normal household waste!

### 10.3 Batteries

The disposal of the rechargeable battery is regulated in the EU by the Battery Directive 2006/66/EC, in Germany by the BattG battery law of 25.6.2009, and internationally by any applicable national laws and regulations.



The AG300 should not be disposed of with normal household waste!

## EG-Konformitätserklärung

Nach Anhang IV der EMV-Richtlinie 2014/30/EU

Nach Anhang IV der EU-Niederspannungsrichtlinie 2014/35/EU

Nach Anhang VI der RoHS-Richtlinie 2011/65/EU (inkl. Delegierte Richtlinie (EU) 2015/863)

Der Hersteller

## EU Declaration of Conformity

*In compliance with Appendix IV of the EMC-Directive 2014/30/EU*

*In compliance with Appendix IV of the LVD-Directive 2014/35/EU*

*In compliance with Appendix VI of the EU RoHS Directive 2011/65/EU (incl. Commission delegated Directive (EU) 2015/863)*

*The manufacturer*

DewertOkin GmbH  
Weststraße 1  
32278 Kirchlengern  
Deutschland - Germany

erklärt hiermit, dass das Produkt

*declares that the following product*

### AG300

#### **mit DewertOkin Antriebssystem / with DewertOkin drive system**

die Anforderungen folgender EG-Richtlinien erfüllt:

*meets the requirements of the following EU directives:*

**Richtlinie über elektromagnetische Verträglichkeit 2014/30/EU**

***Electromagnetic Compatibility Directive 2014/30/EU***

**Niederspannungsrichtlinie 2014/35/EU**

***Low Voltage Directive 2014/35/EU***

**DELEGIERTE RICHTLINIE (EU) 2015/863 DER KOMMISSION vom 31. März 2015 zur Änderung von Anhang II der Richtlinie 2011/65/EU des Europäischen Parlaments und des Rates hinsichtlich der Liste der Stoffe, die Beschränkungen unterliegen.**

***COMMISSION DELEGATED DIRECTIVE (EU) 2015/863 of 31 March 2015 amending Annex II to Directive 2011/65/EU of the European Parliament and of the Council as regards the list of restricted substances.***

Angewendete Normen

*Applied standards:*

- EN 60335-1:2012/A11:2014
- EN 55014-1:2006/A1:2009/A2:2011
- EN 55014-2:1997/A1:2001/A2:2008
- EN 61000-3-2:2014
- EN 61000-3-3:2013
- EN 62233:2008

Konstruktive Änderungen, die Auswirkungen auf die in der Montageanleitung angegebenen technischen Daten und den bestimmungsgemäßen Gebrauch haben, das Produkt also wesentlich verändern, machen diese Konformitätserklärung ungültig!

*This declaration of conformity is no longer valid if constructional changes are made which significantly change the drive system (i.e., which influence the technical specifications found in the instructions or the intended use)!*



Kirchlengern, Germany 25 November 2019

Dr.-Ing. Josef G. Groß  
Geschäftsführer / Managing Director

DewertOkin GmbH  
Weststrasse 1  
Kirchlengern 32278, Germany  
Tel: +49(0)5223/979-0  
Fax.: +49 0 522375182  
<http://www.dewertokin.de>  
[Info@dewertokin.de](mailto:Info@dewertokin.de)

ID No.: 81423