



# Installation Instructions

Floor lighting



# Foreword

## Revisions

Version	Date	Changes
(-)	06/09	First edition
(a)	07/12	Second edition
(b)	12/12	RoHS

## Disclaimer and exclusion of liability

DewertOkin is not responsible for damage resulting from:

- failure to observe these instructions,
- changes made to this product which have not been approved by DewertOkin, or
- the use of replacement parts which have not been approved or manufactured by DewertOkin.

## Contact addresses

DewertOkin GmbH  
 Weststraße 1  
 32278 Kirchlengern  
 Germany  
 Tel: +49 (0)5223/979-0  
 Fax: +49 (0)5223/75182  
<http://www.dewertokin.de>  
[Info@dewertokin.de](mailto:Info@dewertokin.de)

## Creation of a complete operating instruction manual for the entire end product

These instructions are only intended to be used by the end-product manufacturer. They should not be given to the operator of the end product. The factual information contained within may be used as a basis when creating the end-product manual.

The warning and danger notices may be particularly suited for use in the end-product's manual. However it is not sufficient to simply follow these notices. You should also carry out an internal risk assessment for your end product. This can then be used as the basis for the safety notices in your manual.

# Table of Contents



<b>Foreword</b>	<b>3</b>
<b>Revisions</b>	<b>3</b>
<b>Disclaimer and exclusion of liability</b>	<b>3</b>
<b>Contact addresses</b>	<b>3</b>
<b>Creation of a complete operating instruction manual for the entire end product</b>	<b>3</b>
<b>Table of Contents</b>	<b>4</b>
<b>1. General</b>	<b>5</b>
1.1 About these installation instructions	5
1.2 Conventions used	5
<b>2. Safety Notices</b>	<b>6</b>
2.1 Proper and intended usage	6
2.2 Selection and qualification of personnel	7
2.3 Notice on safety during operations	7
2.4 Product labelling	8
<b>3. Description of lighting</b>	<b>9</b>
<b>4. Technical Specifications</b>	<b>10</b>
<b>5. Installation</b>	<b>13</b>
5.1 Safety notices to observe during installation	13
5.2 Installation procedure	14
<b>6. Notices for operation</b>	<b>18</b>
6.1 General notice	18
6.2 Examples of how to use the handset	19
<b>7. Troubleshooting</b>	<b>20</b>
<b>8. Maintenance</b>	<b>21</b>
8.1 Recommended maintenance and inspection intervals	21
8.2 Cleaning and care	21
<b>9. Disposal</b>	<b>22</b>
<b>EU Declaration of conformity</b>	<b>23</b>

# 1. General

## 1.1 About these installation instructions

In order to install this drive successfully and safely in the end product, these installation instructions must be observed. These instructions are not an operating manual for the end product.

These instructions will help you to minimize danger, repair costs and down times. They will also help you to maximize the reliability and lifespan of the end product.

	 <b>CAUTION</b>
	<p>The notices in these instructions must be followed! Their observance during installation and connection will help to minimize</p> <ul style="list-style-type: none"> <li>• the risk of accident and injury, and</li> <li>• damage to the floor lighting or the end product.</li> </ul>

These installation instructions have been written with due care and attention. However, unless otherwise required by law, we do not guarantee that the data, images and drawings are accurate or complete nor do we accept liability for their contents.



- ▶ We reserve the right to make unannounced technical changes in the course of our continual product improvement process!



## 1.2 Conventions used



Notices which do not relate to safety are indicated in these instructions with a triangular symbol:

- ▶ Notice symbol

### Explanations of warning notices

	 <b>DANGER</b>
	DANGER indicates a hazardous situation which, if not avoided, will result in serious injury or death.

	 <b>WARNING</b>
	WARNING indicates a hazardous situation which, if not avoided, could result in serious injury or death.

	 <b>CAUTION</b>
	CAUTION indicates a hazardous situation which, if not avoided, could result in minor or moderate injury.



	<b>NOTICE</b>
	NOTICE is used to address practices which are not related to personal injury but may result in damage to the product or surroundings.

## 2. Safety Notices

### 2.1 Proper and intended usage



The floor lighting is intended to be installed in an end product:



- to illuminate under furniture such as hospital beds,
- for connecting to double drives and drive control units to provide motor adjustment capabilities for movable furniture and hospital beds, and
- for connecting up to two handsets (depending on the design).



	 <b>CAUTION</b>
	The floor lighting should only be used for the applications described above. Any other application is not permitted and can lead to accidents or damage to the unit. Such non-approved applications will lead immediately to the expiration of all guarantee and warranty claims on the part of the end-product manufacturer against DewertOkin.

#### 2.1.1 Improper usage

Be sure to follow the notices below concerning improper usage. You should include them in your product manual in order to inform your end product users.

	 <b>WARNING</b>
	The floor lighting should not be used: <ul style="list-style-type: none"> <li>• in any environment where combustible or explosive gases or vapours (e.g., anaesthesiology) may be present,</li> <li>• in a moist environment, or</li> <li>• outdoors.</li> </ul>

	 <b>CAUTION</b>
	The floor lighting may not be operated by <ul style="list-style-type: none"> <li>• small children.</li> </ul>

	 <b>CAUTION</b>
	You should only use spare parts which have been manufactured or approved by DewertOkin. Only these parts will guarantee a sufficient level of safety.

## 2.2 Selection and qualification of personnel

This floor lighting should only be installed into the end product by someone who has completed training in electronic motor assembly or has equivalent qualifications.

You should only install this floor lighting when you are qualified to do so. Otherwise, a properly qualified person should be found for this task.

## 2.3 Notice on safety during operations

Basic safety rules must be followed in order to ensure that the end product can be continually operated in a safe manner. These rules must be observed while using the end product and while installing the floor lighting.

These rules and safety measures can be categorized as follows:

- construction measures before the installation (refer to the "Ensuring operational reliability during installation" section in the chapter "Installation"),
- safety fundamentals during the installation of the floor lighting and during cable and wire routing (refer to the "Electrical connection" section in the chapter "Installation"),
- basic safety rules during operation (refer to the chapter "Notices for operation"), and
- the creation of a manual for the end product which contains these and other safety rules.

### 2.3.1 Creating a user's manual

The manufacturer of the end product must create a manual for the user of that product. The safety notices in the end-product manual must be written based on the end product's risk assessment.

## 2.4 Product labelling

### 2.4.1 Type label

A rating plate or "type label" on each drive specifies the exact name and serial number of the drive. It also states the technical specifications valid for that particular drive. The following illustration shows where the specifications are located on the rating plate of the floor lighting.

- ▶ The rating plate shown is an example; the specifications for your floor lighting may differ from this illustration.

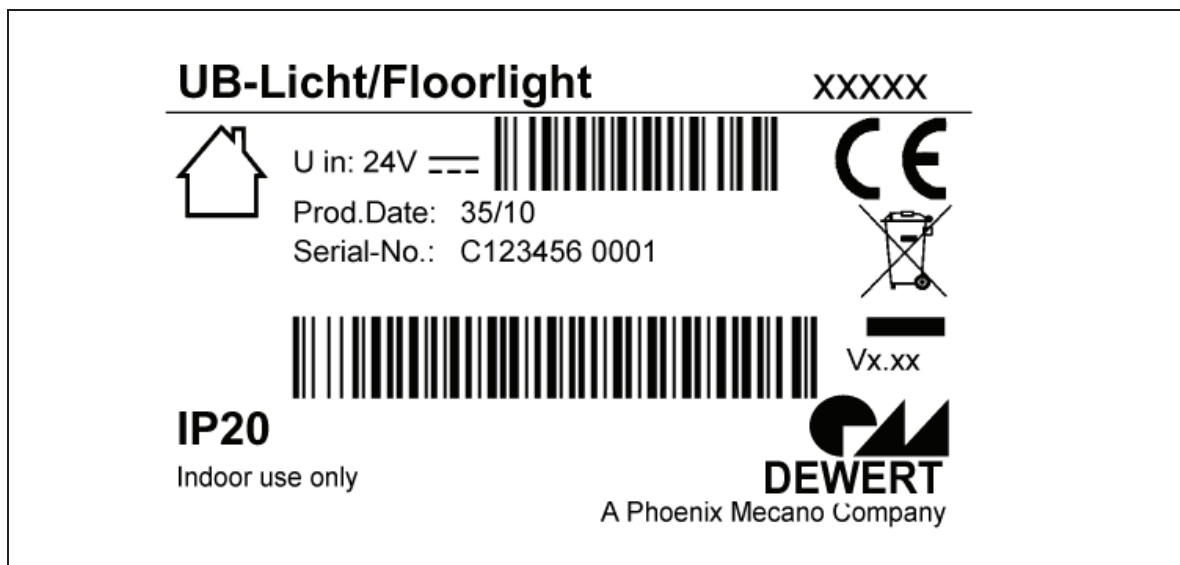





Figure 1 Rating plate example

Under-bed floor light	Model name
xxxxx	Article number
U in: 24 V	Input voltage
Prod.Date	Calendar week / year
Serial-No.	Serial number of the floor lighting
	Use in dry rooms only!
IP20	Protection category
	Mark of CE conformity
	Follow special disposal instructions!
Vx.xx	Software version number (when available)



### 3. Description of lighting

The floor lighting is used exclusively for illumination under furniture or hospital beds. It is used together with a DewertOkin double drive and can be mounted either directly to the double drive or under the end product. A handset can be connected if the floor lighting is equipped with a handset socket.

- We reserve the right to make unannounced technical changes in the course of our continual product improvement process!

The floor lighting is available in the following different versions:

- as a single-body lamp with one socket for a handset,
- as a single-body lamp without a socket for a handset,
- as a single-body lamp with one socket for a handset, for assembly on the DUOMAT 8 double drive,
- as a double-body lamp with a socket for a handset,
- as a double-body lamp with two sockets for handsets, or
- as a double-body lamp without a socket for a handset.

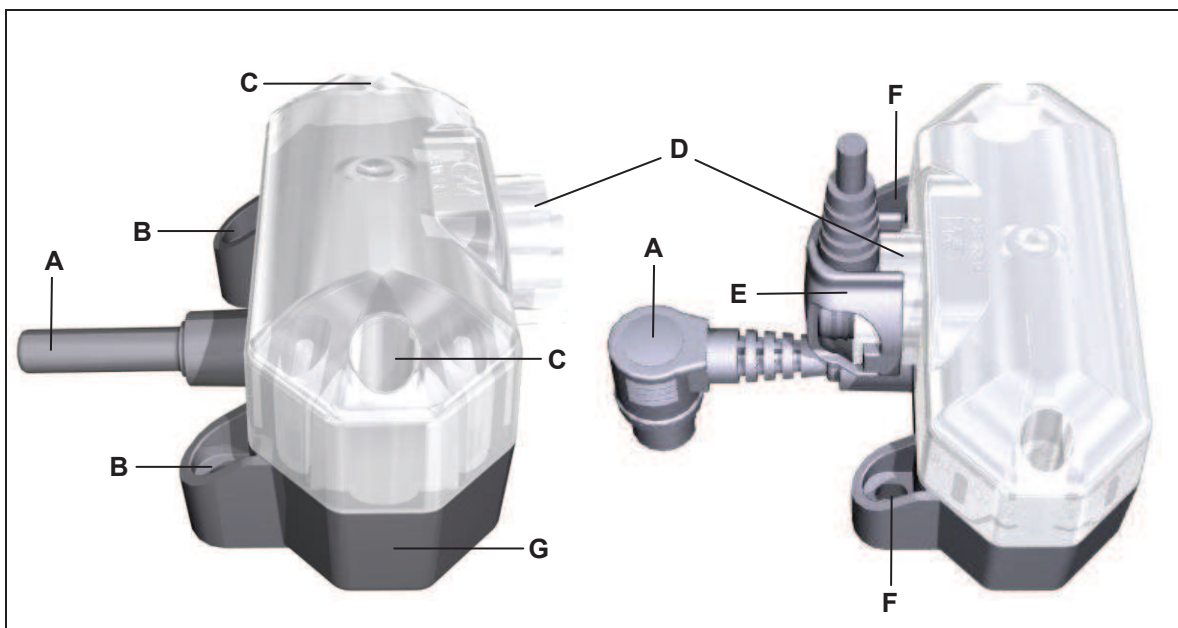

Figure 2 Floor lighting lamp, with handset socket

- |                                                           |                                                                     |
|-----------------------------------------------------------|---------------------------------------------------------------------|
| <b>A</b> Cable or plug for connecting to the double drive | <b>B</b> Mounting holes for mounting on the end product             |
| <b>C</b> Mounting holes for mounting on the end product   | <b>D</b> Handset socket                                             |
| <b>E</b> Snap-on shield cover, with the IP44/IP66 version | <b>F</b> Mounting holes for mounting onto the DUOMAT 8 double drive |
| <b>G</b> Mounting component of lamp                       |                                                                     |

## 4. Technical Specifications

Input voltage	24 V DC
Protection classification	III
Light source	LEDs
Light emitted from diodes	LASER CLASS 1 (EN 60825-1:1994)
Protection category	IP20 (optionally IP44 / IP66)
Colours	Grey / Black
<b>Dimensions and weight</b>	
Length x width x height	
Version with socket	92 mm x 65 mm x 48 mm
Version without socket	92 mm x 54 mm x 48 mm
Weight	Approx. 100 g
<b>Ambient conditions for operation, storage and transport</b>	
Transport / storage temperature	From -20 °C to +50 °C From -4 °F to +122 °F
Operating temperature	From +10 °C to +40 °C From +50 °F to +104 °F
Relative humidity	From 30% to 75%
Air pressure	From 800 hPa to 1060 hPa
Altitude	< 2000 m

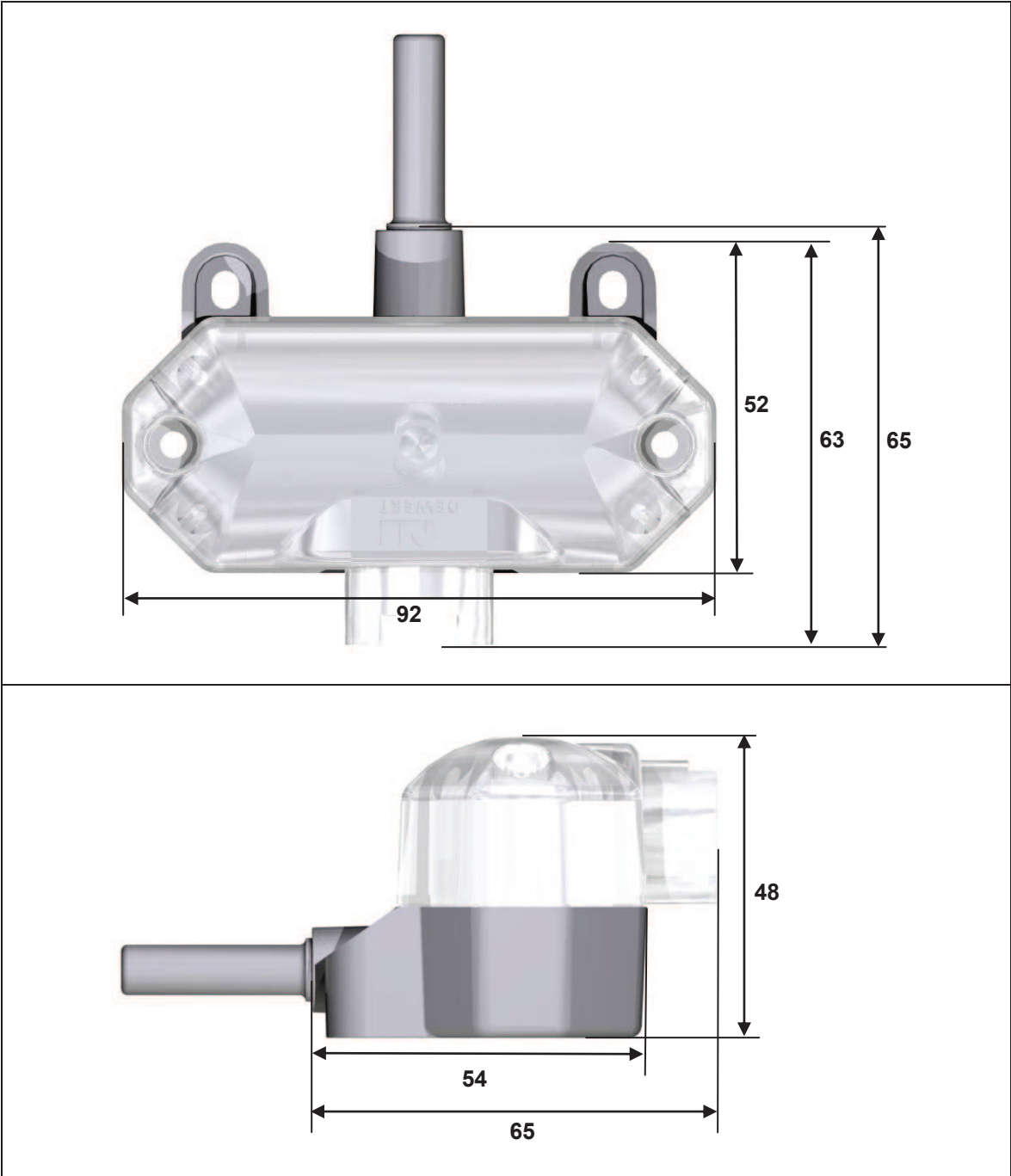

Figure 3 Dimensions of floor lighting with socket for handset (in mm) and cable connection

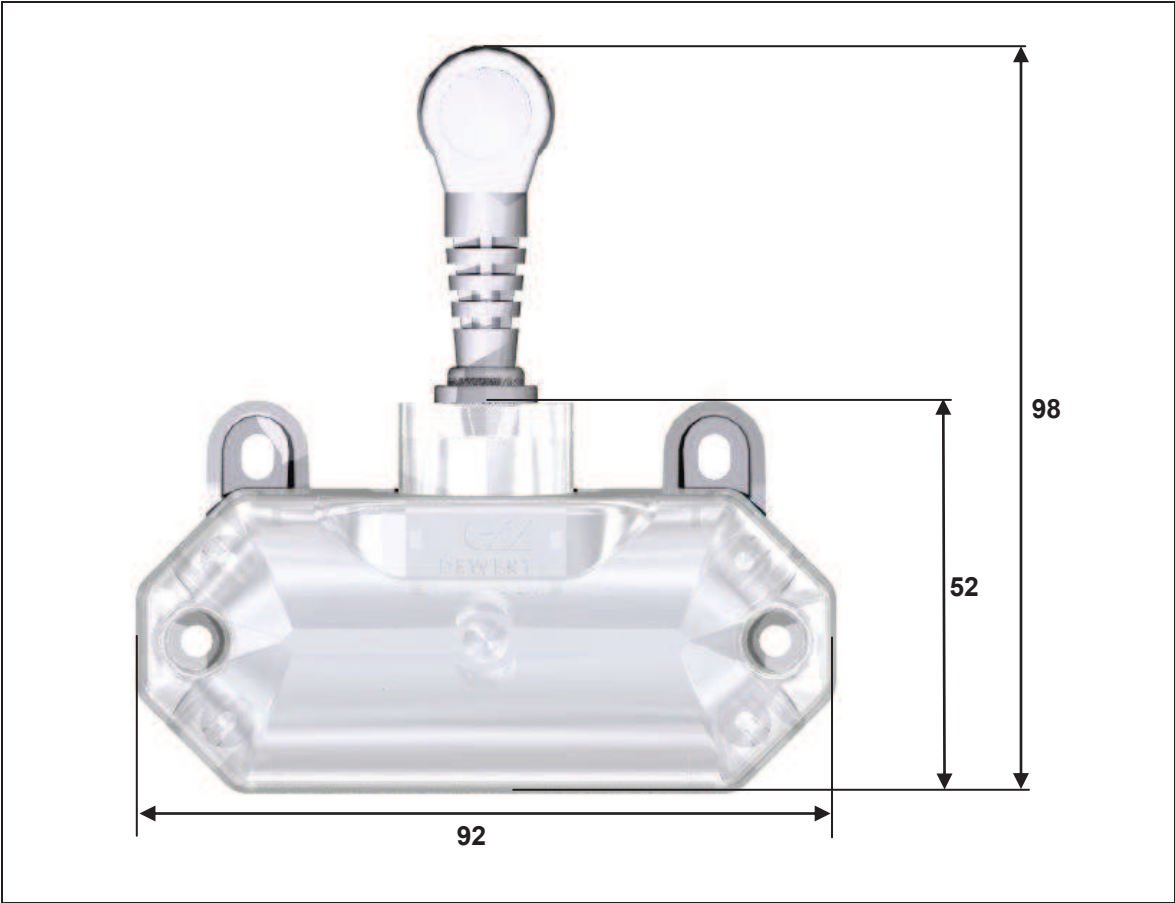

Figure 4 Dimensions of floor lighting, for attachment to double drive (in mm)



## 5. Installation



### 5.1 Safety notices to observe during installation

Basic safety rules must be followed in order to ensure that the end product can be continually operated in a safe manner. These rules must be observed while using the end product and while installing the floor lighting.

#### 5.1.1 Ensuring operational reliability during installation

The safety and reliability of the end product containing DewertOkin components can be ensured by using the proper construction methods described below.

	 <b>CAUTION</b>
	Make sure that the floor lighting is positioned so that it is not possible for someone to look directly into the light.



	 <b>CAUTION</b>
	<p>For versions with IP44 and IP66 protection: Do not use a plug unless it has a sealing washer. Both the floor lighting plug and the handset plug must have a sealing washer. The washers ensure that the connections are properly protected against any splashed water.</p> <p>An additional shield cover to protect against unplugging is also required for IP66 protection. This shield cover can only be removed with a screwdriver.</p>

	<b>NOTICE</b>
	Do not remove the dummy plugs from the unused handset sockets on the floor lighting.

## 5.2 Installation procedure

Before installing the floor lighting, make sure that you are observing all of the safety notices found in the "Safety notices to observe during installation" section.

### 5.2.1 Installation and dismantling for the floor lighting

	 <b>CAUTION</b>
	The mains power plug on the drive should be unplugged during the installation.

The floor lighting can be screwed onto the end product using the mounting holes. Use at least two suitable screws (for example, at mounting hole A: a 3.9 x 15 screw; at mounting point B: a 3.9 x 30 screw – also refer to Figure 5). The floor lighting must lie flat and level on its supporting surface. It should only be fastened under the end product or to a double drive. In the end product, no mechanical forces should be put on the floor lighting. Such forces could lead to damage (such as cracks) in the housing.

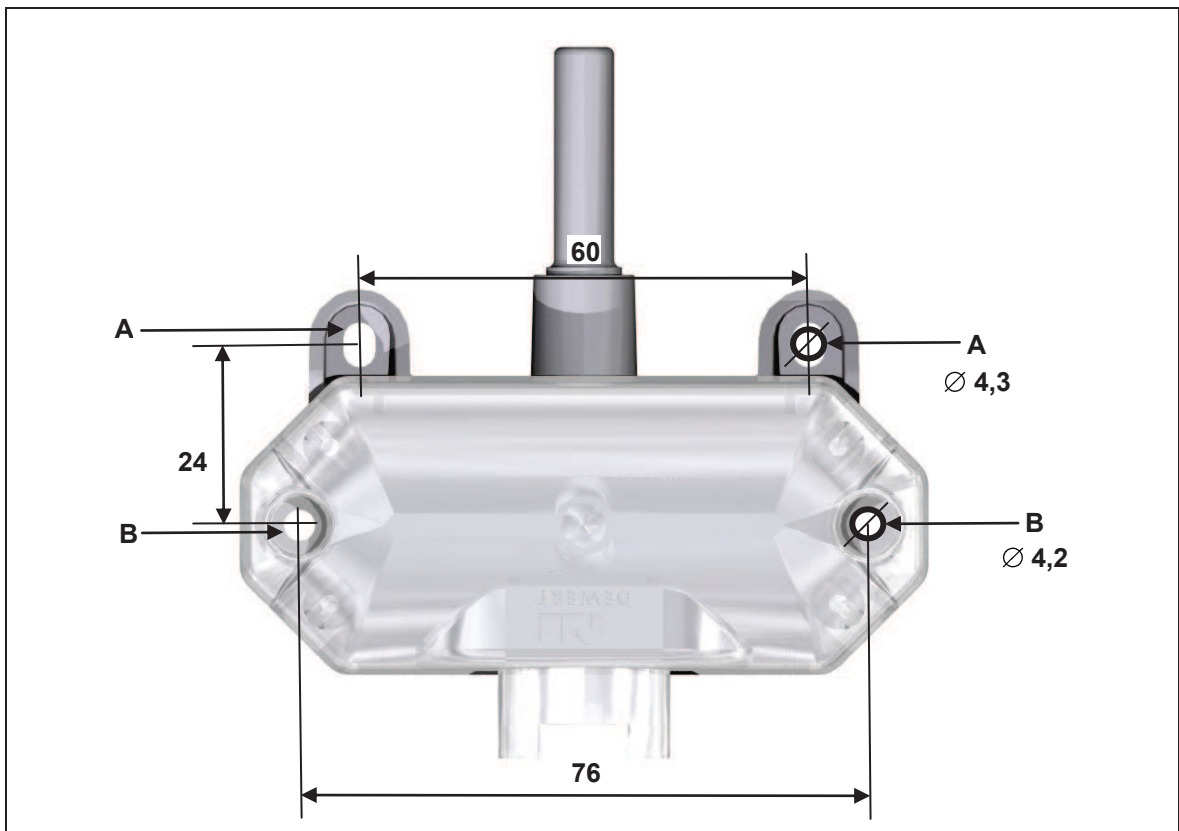



Figure 5 Mounting holes in the floor lighting (dimensions in mm)

### 5.2.2 Mounting the floor lighting onto the end product

- 1 Select a suitable location for attaching the floor lighting.
- 2 Use at least two screws per lamp when attaching the floor lighting. (The mounting holes are shown in Figure 5.)
- 3 Connect the floor lighting plug to the attached double drive or to the corresponding socket on the drive control unit.

	<p data-bbox="395 611 1442 672"> <b>CAUTION</b></p> <p data-bbox="395 683 1442 819">For versions with IP44 and IP66 protection: Do not use a plug unless it has a sealing washer. Both the floor lighting plug and the handset plug must have a sealing washer. The washers ensure that the connections are properly protected against any splashed water.</p>
-----------------------------------------------------------------------------------	-------------------------------------------------------------------------------------------------------------------------------------------------------------------------------------------------------------------------------------------------------------------------------------------------------------------------------------------------------------------------------------------------------------------------------------------------

- 4 Connect the handset plug to the handset socket on the floor lighting (if available, refer to Figure 2).
- 5 Snap on the shield cover. The handset plug is securely connected to the drive once the cover is properly snapped on.
- 6 Close off the unused handset sockets using dummy plugs.

**5.2.3 Mounting the floor lighting to a double drive (for example, the DUOMAT 8)**

If you have purchased the "single-body lamp for assembly on a double drive" version of the floor lighting, then the floor lighting should be attached directly to the double drive.

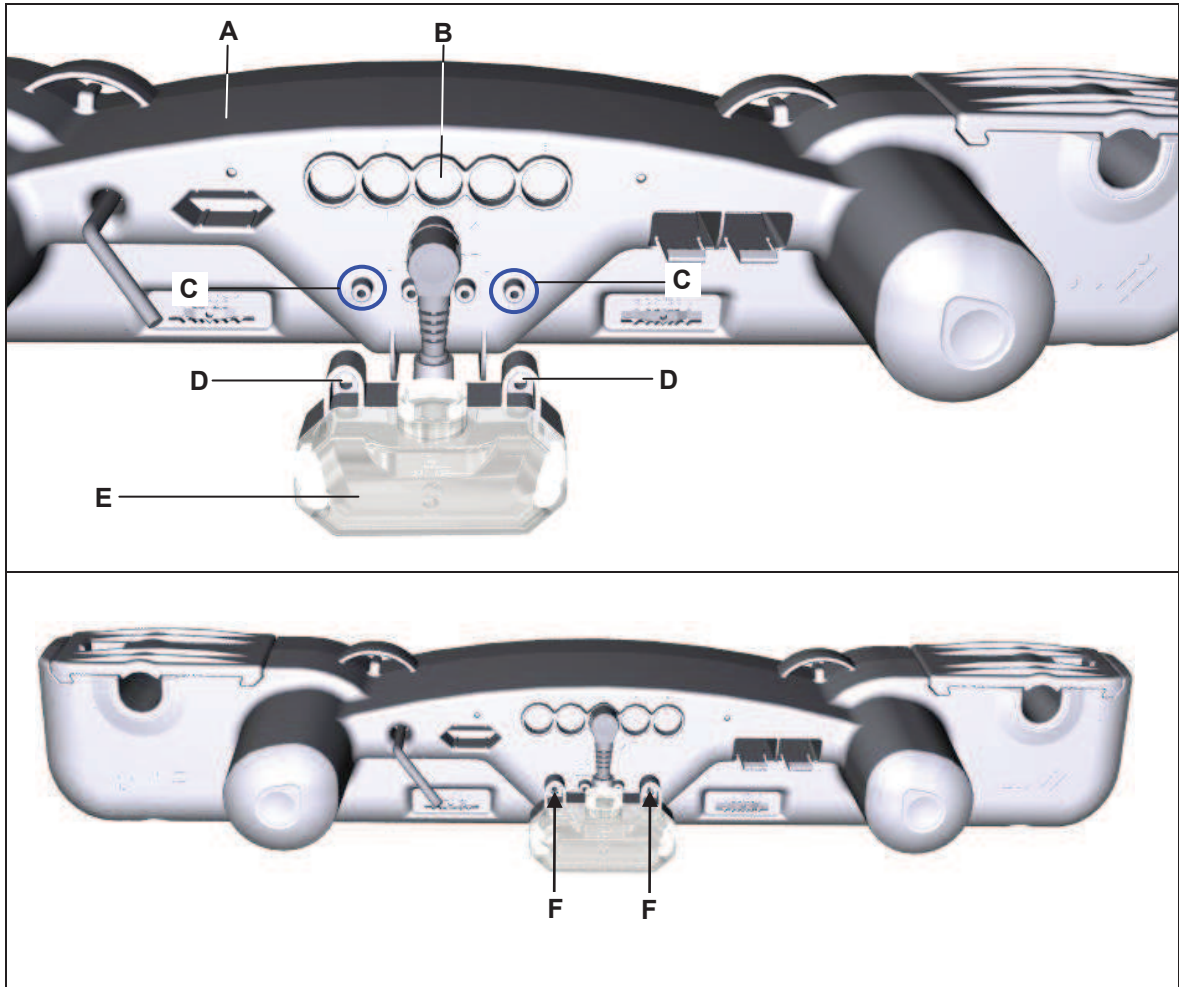



Figure 6 Mounting to a double drive (for example, the DUOMAT 8)

- |                                           |                                                    |
|-------------------------------------------|----------------------------------------------------|
| <b>A</b> DUOMAT 8 double drive            | <b>B</b> Socket on the DUOMAT 8 double drive       |
| <b>C</b> Support dome on the double drive | <b>D</b> Mounting holes on the floor lighting      |
| <b>E</b> Floor lighting                   | <b>F</b> Threaded screw connection on support dome |

- 1 Place the floor lighting onto the support dome of the double drive. The double drive should already be attached to the end product.
- 2 Use two screws (for example, two 3.9 x 15 mm screws) to attach the floor lighting to the support dome on the double drive.
- 3 Connect the plug on the floor lighting to the double drive.



#### 5.2.4 Electrical connection

	 <b>CAUTION</b> Electrical components should be connected or disconnected only when the mains power cord is unplugged.
-----------------------------------------------------------------------------------	------------------------------------------------------------------------------------------------------------------------------------------------------------------------------------------------------------

##### Routing electrical cables



When routing the cables, be sure that:

- the cables cannot get jammed,
- no mechanical load (such as pulling, pushing or bending) will be put on the cables, and
- the cables cannot be damaged in any way.

Fasten all cables (especially the connecting cables) to the end product using sufficient strain relief and kink prevention methods. Be sure that the design of the end product prevents the connecting cables from coming into contact with the floor during transport.

## 6. Notices for operation

The factual information contained within may be used when you are creating the end-product manual. The installation instructions do not contain all information required for the safe operation of the end product. They only describe the assembly and operation of the floor lighting and do not describe the completed end product.



	 <b>CAUTION</b>
	When creating the operating instructions, remember that the installation instructions are intended for qualified specialists and are not for typical users of the end product.

### 6.1 General notice

- ▶ Only handsets from DewertOkin should be connected to the floor lighting since they have already been verified to work together.



#### Avoiding damage from laser light

Be sure that your operating instructions inform the user about the possible risks associated with lasers.

	 <b>CAUTION</b>
	Do not look directly into this light and do not point the light into other people's eyes.

#### Avoiding cable damage

Be sure that your operating instructions inform the user about the possible cable risks.

	 <b>CAUTION</b>
	The cables (particularly the connecting cable) should not be run over. In order to prevent injuries or damage to the floor lighting, no mechanical strain should be placed on the cables.

## 6.2 Examples of how to use the handset

Depending on the version of your handset, the floor lighting can be switched on and off using either one or two buttons.

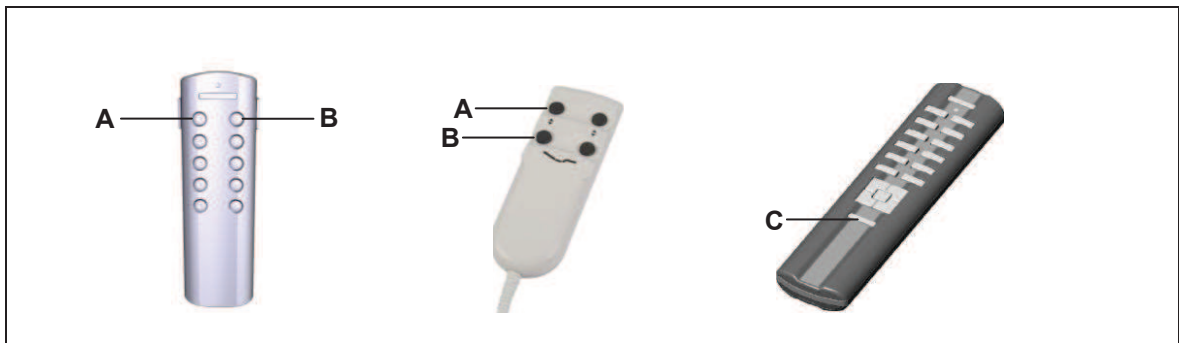



Figure 7 Handset models

- A** UP button for the first motor on the double drive
- B** DOWN button for the first motor on the double drive
- C** Light button on the handset (when available). Indicated with the following symbol: 

### Turning on and off

The floor lighting can be turned on by simultaneously pressing the UP and DOWN buttons for the double drive's first motor. The same two buttons can be used to turn off the floor lighting.

Depending on the version of the handset, the UP and DOWN buttons for the double drive's first motor are located either in the upper row of buttons or as the left-most pair of buttons on the handset (refer Figure 7).

- ▶ Some special handset versions have only a single button which is used for turning the lighting on and off.



<b>NOTICE</b>	
	For the battery-drive emergency lowering option: The floor lighting should only be used for short-term illumination purposes. The floor lighting is not designed for long-term use because such use could cause the drive system batteries to discharge.

- ▶ Additional information about operating the handset can be found in the operating instructions included with your handset.

<b>NOTICE</b>	
	Close off the unused handset sockets using dummy plugs. The protection against splashed water is compromised with open sockets. In extreme cases, such open sockets can lead to the destruction of the floor lighting or the drive.



## 7. Troubleshooting

This chapter describes troubleshooting methods for fixing problems. If you experience an error that is not listed in this table, please contact your supplier.

	 <b>CAUTION</b>
	<p>Only qualified specialists who have received electrician training should carry out troubleshooting and repairs.</p>

Problem	Possible cause	Remedy
The floor lighting is not functioning	There is no mains supply voltage.	Connect the mains power.
	The power feed (from the mains) has been interrupted.	Check the lead-in connections and re-seat the contacts if required.
	The LED is defective.	Please contact your supplier or sales agent

## 8. Maintenance

	 <b>CAUTION</b>
	<p>You should only use spare parts which have been manufactured or approved by DewertOkin. Only these parts will guarantee a sufficient level of safety.</p>

### 8.1 Recommended maintenance and inspection intervals

Type of check	Explanation	Time interval
Check the function and safety of the electrical system	A qualified electrician should carry out this inspection. (Refer to the "Electrical connection" section in the "Installation" chapter.)	Periodic inspections can be carried out at intervals based on the risk assessment which you conduct for your end product.
Periodic visual inspection for housing damage	Check the housing for breaks or cracks.	At least every six months
Periodic visual inspection of the plug-in connections and electrical access points for damage	Check that all electrical cables and connections are firmly seated and correctly positioned	At least every six months
Periodic visual inspection for cable damage	Check the connecting cables for pinching or shearing. Also check the strain relief and kink protections mechanisms, in particular after any mechanical load.	At least every six months

### 8.2 Cleaning and care

This floor lighting was designed so that it would be easy to clean.

	<b>NOTICE</b>
	<p>Never clean the floor lighting in an automated washing system or with a high-pressure cleaner. Do not allow fluids to penetrate the lighting. Damage to the lighting could result.</p> <p>Do not use a cleanser that contains benzene, alcohol or similar solvents.</p>

- 1 Always disconnect the mains power plug before you start to clean the drive!
- 2 Clean the floor lighting (UBB) using a moist cloth.
- 3 Be sure that you do not damage the connecting cables during the cleaning.

## 9. Disposal

This floor lighting consists of electronic components, cables and metal and plastic parts. You should observe all corresponding national and regional environmental regulations when disposing of the floor lighting.

The disposal of the end product is regulated in Germany by Elektro-G, internationally by the EU Directive 2012/19/EC (WEEE), or by any applicable national laws and regulations.



This floor lighting should not be disposed of with normal household waste!

## EG-Konformitätserklärung

Nach Anhang IV der EMV-Richtlinie 2014/30/EU

Nach Anhang IV der EU-Niederspannungsrichtlinie 2014/35/EU

Nach Anhang VI der RoHS-Richtlinie 2011/65/EU (inkl. Delegierte Richtlinie (EU) 2015/863)

Der Hersteller

## EU Declaration of Conformity

*In compliance with Appendix IV of the EMC-Directive 2014/30/EU*

*In compliance with Appendix IV of the LVD-Directive 2014/35/EU*

*In compliance with Appendix VI of the EU RoHS Directive 2011/65/EU (incl. Commission delegated Directive (EU) 2015/863)*

*The manufacturer*

DewertOkin GmbH  
Weststraße 1  
32278 Kirchlengern  
Deutschland - Germany

erklärt hiermit, dass das Produkt

*declares that the following product*

### **UB-Licht/Floorlight mit/with DewertOkin-Steuerung/control unit**

die Anforderungen folgender EG-Richtlinien erfüllt:

*meets the requirements of the following EU directives:*

**Richtlinie über elektromagnetische Verträglichkeit 2014/30/EU**

***Electromagnetic Compatibility Directive 2014/30/EU***

**Niederspannungsrichtlinie 2014/35/EU**

***Low Voltage Directive 2014/35/EU***

**DELEGIERTE RICHTLINIE (EU) 2015/863 DER KOMMISSION vom 31. März 2015 zur Änderung von Anhang II der Richtlinie 2011/65/EU des Europäischen Parlaments und des Rates hinsichtlich der Liste der Stoffe, die Beschränkungen unterliegen.**

***COMMISSION DELEGATED DIRECTIVE (EU) 2015/863 of 31 March 2015 amending Annex II to Directive 2011/65/EU of the European Parliament and of the Council as regards the list of restricted substances.***

Angewendete Normen

*Applied standards:*

- EN 60335-1:2012/A11:2014
- EN 55014-1:2006/A1:2009/A2:2011
- EN 55014-2:1997/A1:2001/A2:2008
- EN 61000-3-2:2014
- EN 61000-3-3:2013
- EN 62233:2008
- 

Konstruktive Änderungen, die Auswirkungen auf die in der Montageanleitung angegebenen technischen Daten und den bestimmungsgemäßen Gebrauch haben, das Produkt also wesentlich verändern, machen diese Konformitätserklärung ungültig!

*This declaration of conformity is no longer valid if constructional changes are made which significantly change the drive system (i.e., which influence the technical specifications found in the instructions or the intended use)!*

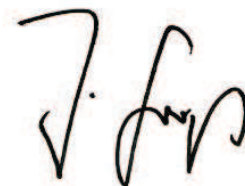

Kirchlengern, Germany 25 November 2019

Dr.-Ing. Josef G. Groß  
Geschäftsführer / Managing Director

DewertOkin GmbH  
Weststraße 1  
32278 Kirchlengern, Germany  
Tel: +49 (0)5223/979-0  
Fax: +49 (0)5223/75182  
<http://www.dewertokin.de>  
[Info@dewertokin.de](mailto:Info@dewertokin.de)

ID No.: 64412