

PD14/PD15 Power Supply

Installation Instructions

(Translation of the original installation instructions)

Foreword

Document revision history

Version	Date	Modification, change
(-)	12/2013	First release
(a)	05/2014	Ratings plate
(b)	01/2016	Power plug variants

Disclaimer and exclusion of liability

DewertOkin is not responsible for damage resulting from:

- failure to observe these instructions,
- changes made to this product which have not been approved by DewertOkin, or
- the use of replacement parts which have not been approved or manufactured by DewertOkin.

Contact addresses

DewertOkin GmbH
 Weststraße 1
 32278 Kirchlengern, Germany
 Germany
 Tel: +49(0)5223/979-0
 Fax.: +49 0 522375182
<http://www.dewertokin.de>
Info@dewertokin.de

Creation of a complete operating instruction manual for the entire end product

These instructions are only intended to be used by the end-product manufacturer. They should not be given to the operator of the end product. The factual information contained within may be used as a basis when creating the end-product manual.

The warning and danger notices are best suited for use in the end product's manual. However it is not sufficient to simply follow these notices. You should also carry out an internal risk assessment for your end product. This can then be used as the basis for the safety notices in your manual.

Usage in medical products

The PD14/PD15 Power Supply is not a medical product. If used in a medical end product, you (the end manufacturer) are obliged to ensure compliance with EC directives and to ensure that other pertinent medical product regulations are maintained.

Notice for customers in EU nations**German Inspection Authority (TÜV SÜD Product Service) testing label**

The construction of the PD14/PD15 Power Supply has been inspected by the German Inspection Authority (TÜV SÜD Product Service). The TÜV SÜD Product Service also monitors the production of the PD14/PD15 Power Supply. The official German TÜV SÜD Product Service certifies this construction inspection and production monitoring.

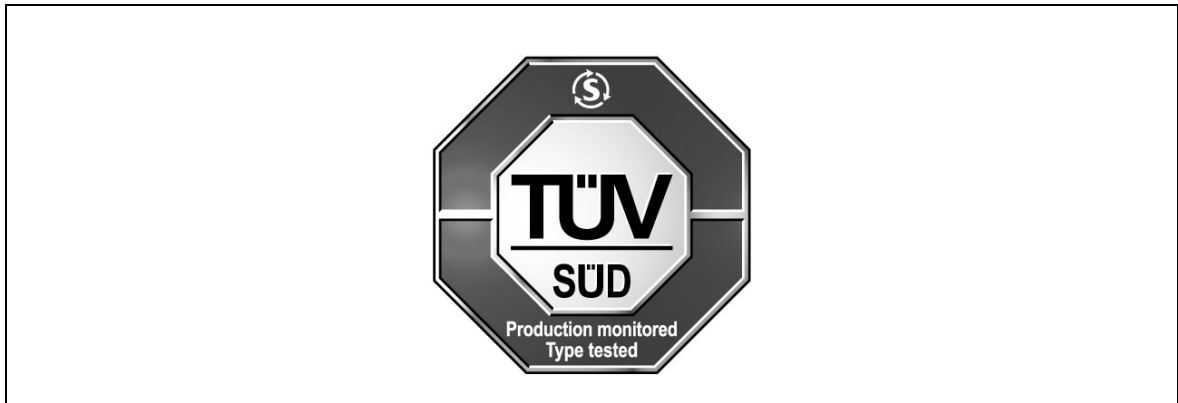

Figure 1 The TÜV SÜD Product Service Safety Mark

Table of contents

Foreword	3
Document revision history	3
Disclaimer and exclusion of liability	3
Contact addresses	3
Creation of a complete operating instruction manual for the entire end product	3
Usage in medical products	3
Notice for customers in EU nations	4
Table of contents	5
1. General Information	7
1.1 About these installation instructions	7
1.2 Conventions used	7
2. Safety Instructions	8
2.1 Proper and Intended Usage	8
2.2 Selection and qualification of personnel	9
2.3 Notice on safety during operations	9
2.4 Product labelling	10
3. Description	12
3.1 Components	12
4. Technical Specifications	15
4.1 PD14/PD15 Power Supply	15
5. Installation	17
5.1 Safety notices to observe during installation	17
5.2 Installation procedure	17
6. Operating Notes	20
6.1 General information	20
7. Troubleshooting	22
8. Maintenance	23
8.1 Maintenance	23
8.2 Cleaning and care	23



9.	Disposal	24
9.1	Packaging material	24
9.2	Components in the PD14/PD15 Power Supply	24
EU Declaration of Conformity		25
Additional information		26

1. General Information

1.1 About these installation instructions

These installation instructions must be observed in order to install this PD14/PD15 Power Supply successfully and safely in the end product. These instructions are not an operating manual for the end product.

These instructions will help you to minimize danger, repair costs and down times. They will also help you to maximize the reliability and lifespan of the end product.

 CAUTION
 <p>The notices in these instructions must be followed! Following the guidelines during installation and connection procedures will help to minimize:</p> <ul style="list-style-type: none"> • the risk of accident and injury, and • damage to the PD14/PD15 Power Supply or to the end product.

These installation instructions have been written with due care and attention. However, we cannot guarantee that the data, images and drawings are complete and correct nor do we accept any liability for the information contained therein, unless required by law.



- ▶ We reserve the right to make unannounced technical changes in the course of our continual product improvement process!



1.2 Conventions used

Notices which do not relate to safety are indicated in these instructions with a symbol:

- ▶ Triangular notice symbol

Explanations of warning notices

 CAUTION
 <p>CAUTION indicates a hazardous situation which, if not avoided, could result in minor or moderate injury.</p>



 NOTICE
 <p>NOTICE is used to address practices which are not related to personal injury but may result in damage to the product or surroundings.</p>

2. Safety Instructions

2.1 Proper and Intended Usage



The PD14/PD15 Power Supply is intended for use:



- as a power supply unit for suitable DewertOkin drive systems.

	 CAUTION
	<p>This PD14/PD15 Power Supply should only be used for the applications described above. Any other form of usage is not permitted and can lead to accidents or destruction of the unit. Such non-approved applications will lead immediately to the expiration of all guarantee and warranty claims on the part of the end-product manufacturer against the manufacturer.</p>

2.1.1 Improper usage

Be sure to follow the notices below concerning improper usage. You should include them in your product manual in order to inform the users of your end product.

	 CAUTION
	<p>The PD14/PD15 Power Supply may not be used:</p> <ul style="list-style-type: none"> • in any environment where combustible or explosive gases or vapours (e.g., anaesthesiology) may be present, • in the proximity of open fires or other heat sources (such as furnaces, ovens or direct sunlight), • as a power source for toys or games, • in any application that will be cleaned with an automated washing system, • in a moist environment, or • outdoors.

	 CAUTION
	<p>The PD14/PD15 Power Supply may not be operated:</p> <ul style="list-style-type: none"> • by small children, • by frail or infirm persons without supervision, or • in the proximity of small children.

The PD14/PD15 Power Supply can be used by children of 8 years and older, persons with reduced physical, sensory or mental capabilities, or persons with lack of experience or knowledge when they are supervised or instructed concerning the safe use of the device and when they understand the resulting risks. Do not allow children to play with this device. The cleaning and user maintenance must not be carried out by children without supervision.

- ▶ You should only use spare parts which have been manufactured or approved by DewertOkin. Only these parts will guarantee a sufficient level of safety.

2.2 Selection and qualification of personnel

This PD14/PD15 Power Supply should only be installed into the end product by someone who has completed training in electronic motor assembly or has equivalent qualifications.

You should only install this PD14/PD15 Power Supply when you are qualified to do so. Otherwise, a properly qualified person should be found for this task.

2.3 Notice on safety during operations

Basic safety rules must be followed in order to ensure that the end product can be continually operated in a safe manner. These rules must be observed while using the end product and while installing the PD14/PD15 Power Supply.



These rules and safety measures can be categorized as follows:

- Construction measures before the installation (refer to the "Ensuring operational reliability during installation" section in Chapter "Installation").
- Safety fundamentals during the PD14/PD15 Power Supply installation and during cable and wire routing (refer to the "Electrical connection" section in the chapter "Installation").
- Basic safety rules during operation (refer to the "Operating Notes" Chapter).
- The creation of a manual for the end product which contains these and other safety rules.

2.3.1 Creating a user's manual

The manufacturer of the end product must create a manual for the users of that product. The safety notices in the end-product manual must be written based on the end product's risk assessment.

2.3.2 Electrical safety

	 CAUTION
	Be careful; there is a risk of electrical shock! The PD14/PD15 Power Supply must not be opened! You must properly dispose of malfunctioning or broken units.

2.4 Product labelling

2.4.1 Type plate

A ratings plate (or type label) on each PD14/PD15 Power Supply specifies the exact name and serial number of unit. It also states the technical specifications valid for that particular PD14/PD15 Power Supply. The following illustration shows where the specifications are located on the ratings plate of the PD14/PD15 Power Supply.

- ▶ The ratings plate shown is an example; the specifications for your PD14/PD15 Power Supply may differ from this illustration.

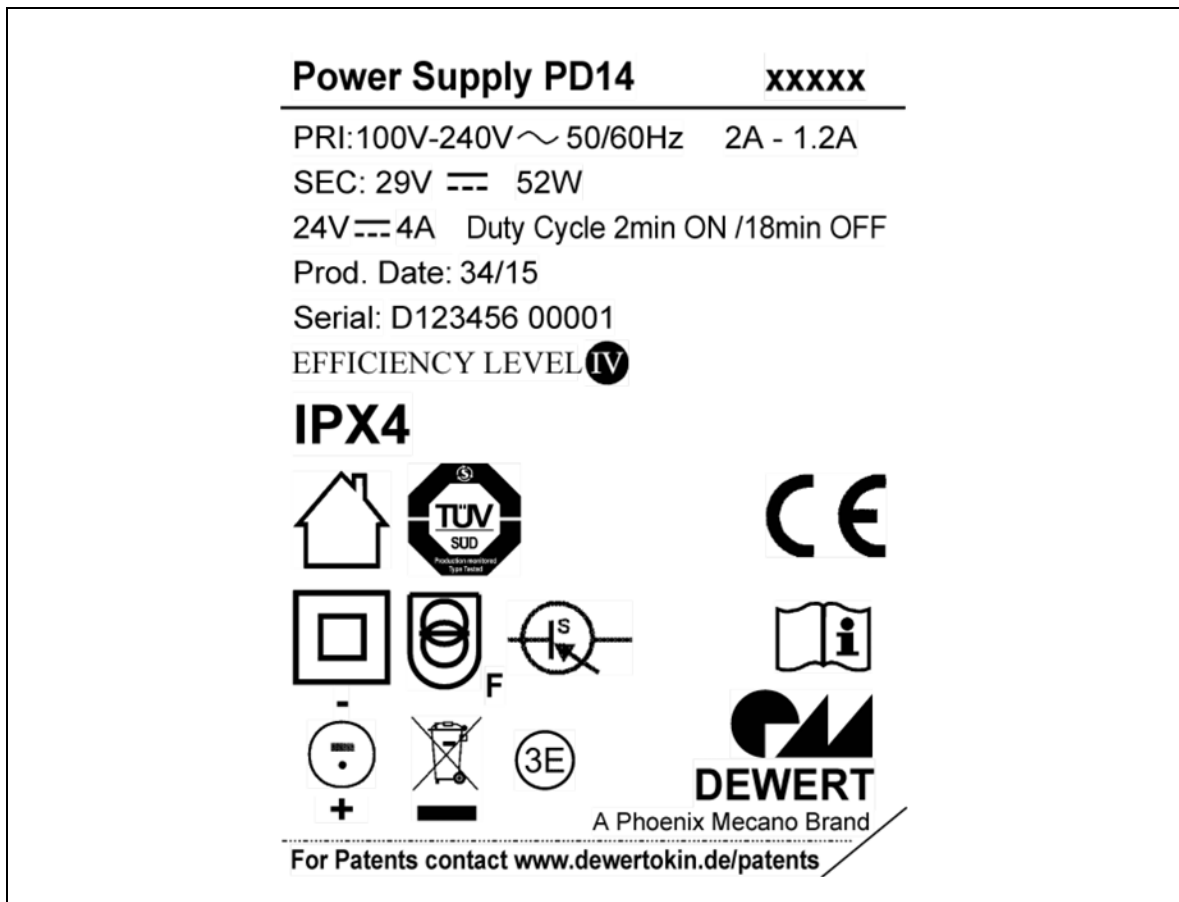











Figure 2 PD14/PD15 Power Supply ratings plate (example)

- ▶ The actual specifications on the PD15 Power Supply's rating plate are different than this example but have the same meaning.

PD14 Power Supply	Model name
xxxxx	ID No.
100 V - 240 V ~ 50/60 Hz	Input voltage and frequency
2A – 1.2A	Current consumption
SEC: 29V \approx 52W	Output voltage and permitted max. output power during continuous operations
24V \approx 4A	Output voltage and permitted max. output power for intermittent operations: 2 minutes on / 18 minutes OFF
Duty cycle: 2 min ON / 18 min OFF	Intermittent operations: 2 minutes on / 18 minutes OFF
Prod. Date	Calendar week / year
Serial	Serial number
EFFICIENCY LEVEL 	Efficiency class
IPX4	Protection degree
	Use in dry rooms only!
	Protection class II
	Fail-safe safety transformer
	Switched-mode power supply
	LSP plug
	Follow all special disposal instructions!
	Standards label: refer to additional information
	Compliance
	Follow special assembly instructions!

3. Description

The PD14/PD15 Power Supply is an external power supply unit used for DewertOkin drive systems. The PD14/PD15 Power Supply has a non-referenced (unearthed) circuit which is separated from the supply voltage by means of doubled reinforced insulation.

An LSP socket is used to connect the drive system to the PD14/PD15 Power Supply.

- ▶ We reserve the right to make unannounced technical changes in the course of our continual product improvement process!

3.1 Components

The PD14/PD15 Power Supply consists of a housing enclosure with integrated mains power plug and a cable to connect the drive system.

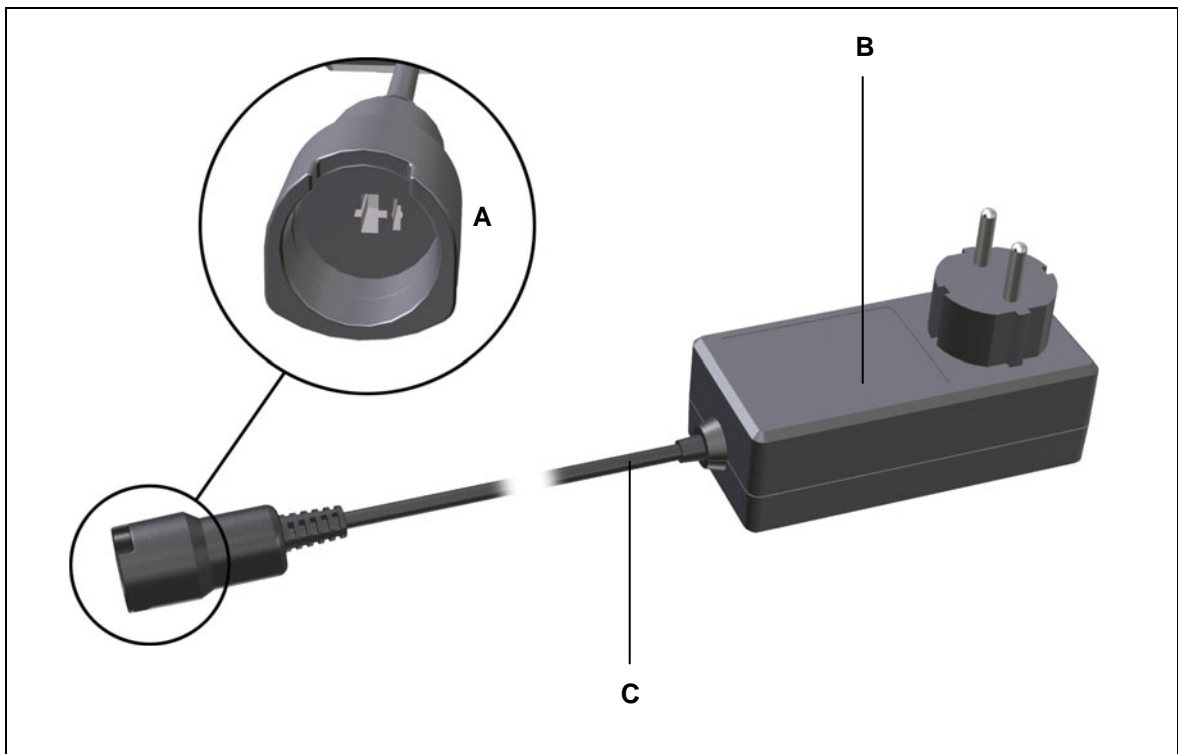

Figure 3 Components of the PD14/PD15 Power Supply

- A** LSP socket for connecting (the drive system) **B** PD14/PD15 Power Supply
C Connection cable

Power plug variants

The following illustration shows the proper power plug adapters for regional usage.

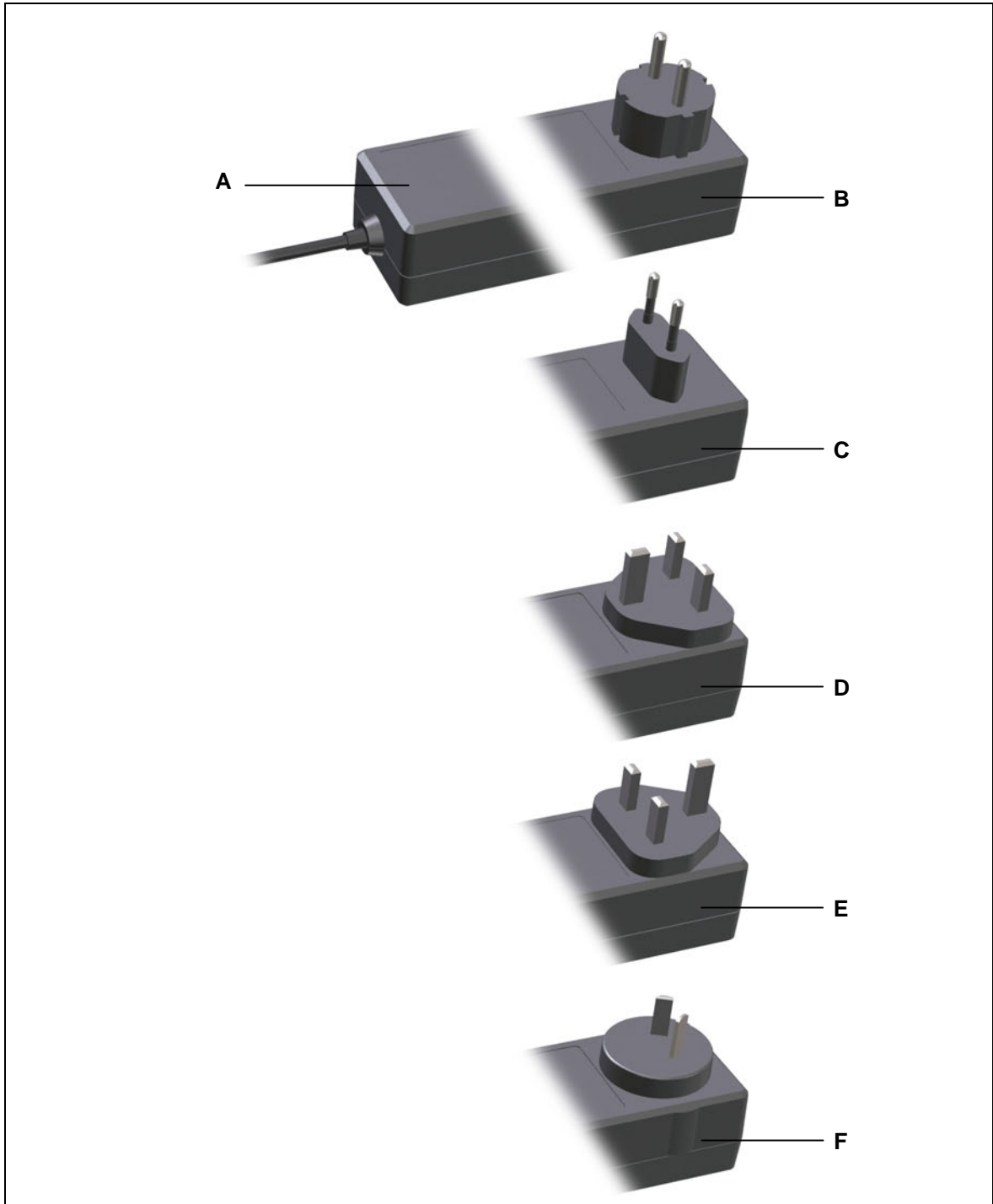

Figure 4 Power plug variants

A PD14/PD15 Power Supply

C Euro power plug

E UK power plug

B Europlug CEE 7/17

D UK power plug, rotated

F Australian power plug

3.1.1 Electrical outlet

An LSP outlet socket is used to connect the drive system.

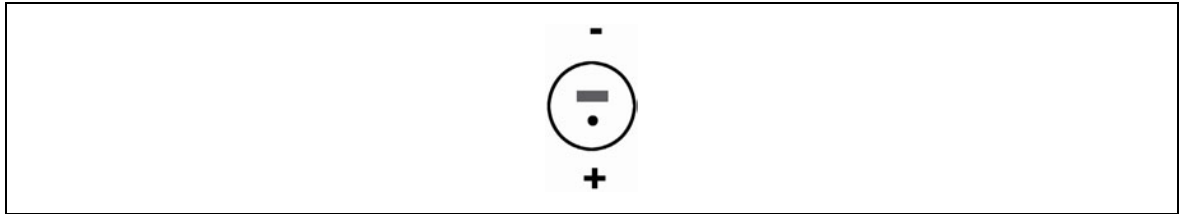



Figure 5 Outlet for the LSP socket

4. Technical Specifications

4.1 PD14/PD15 Power Supply

Mains power supply	100 – 240 V AC 50/60 Hz	
Output voltage (under no load)	29 V DC	
	PD14	PD15
Output voltage / output power	Output: 29 V $\overline{=}$ 52 W for continuous operations	Output: 29 V $\overline{=}$ 58 W for continuous operations
Output voltage / output current	24 V $\overline{=}$ 4 A for intermittent operations: 2 min./18 min.	29 V $\overline{=}$ 5.5 A for intermittent operations: 2 min./18 min.
Primary fuse	Available	Available
Standby (no load)	≤ 0.5 W	≤ 0.3 W
Degree of efficiency	≥ 0.87	≥ 0.85
Operating current	< 0.1 mA	< 0.1 mA
Mode of operations ¹	Intermittent duty 2 min./18 min. Continuous operations	
Efficiency class	EFFICIENCY LEVEL 	
Protection class	II	
Protection degree	IPX4	
Colour	Black	
Dimensions and weight		
Length x width x height	111.3 mm x 53.5 mm x 38.5 mm	
Weight	Approx. 350 g	
Ambient conditions for operation, storage and transport		
Transport / storage temperature	From -20 °C to +50 °C From -4 °F to +122 °F	
Operating temperature	From +10 °C to +40 °C From +50 °F to +104 °F	
Relative humidity	From 30% to 75%	
Air pressure	From 800 hPa to 1060 hPa	
Height	< 2000 m	

¹ Mode of operation: intermittent duty 2 min./18 min. This means that after the unit is operated with its rated load for up to two minutes it must then be paused for 18 minutes. The system can malfunction if this pause is not observed!

4.1.1 Dimension of the PD14/PD15 Power Supply

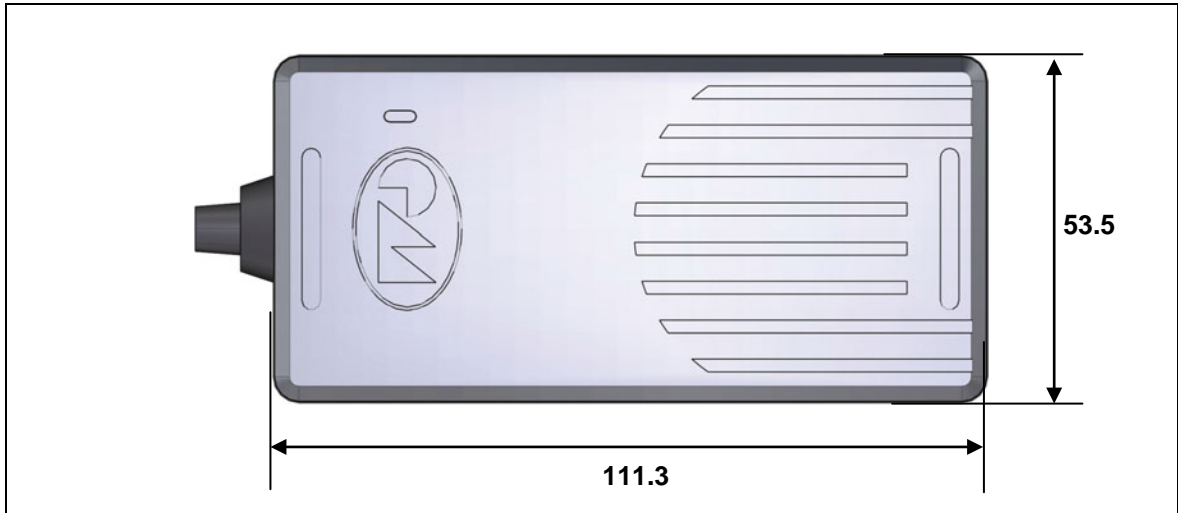

Figure 6 Dimensions of the PD14/PD15 Power Supply, in mm, top view

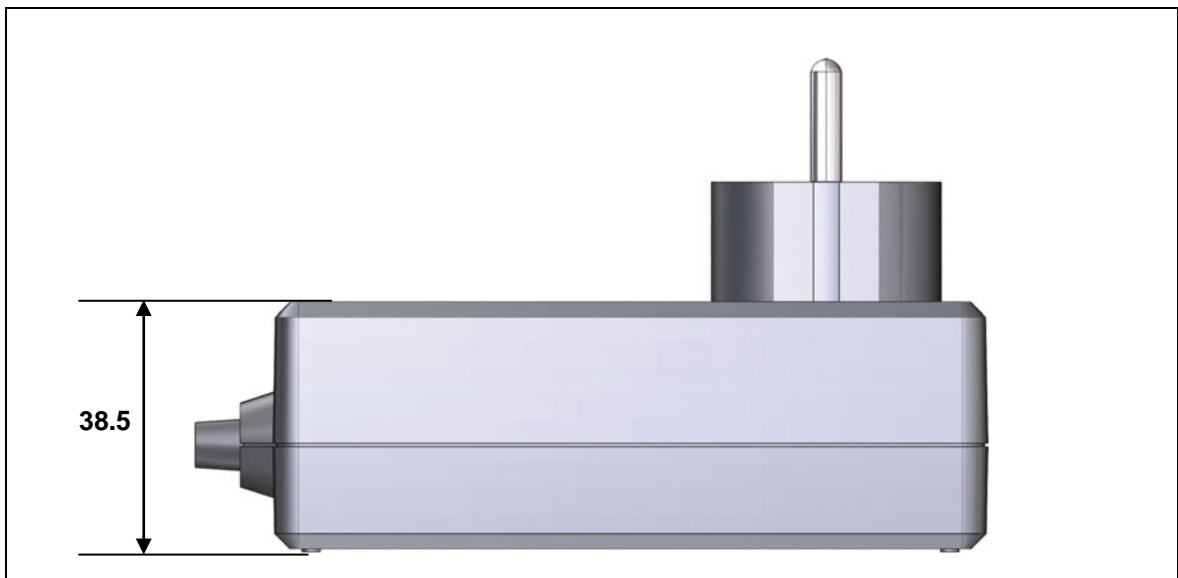

Figure 7 Dimensions of the PD14/PD15 Power Supply, in mm, side view

5. Installation

5.1 Safety notices to observe during installation

Basic safety rules must be followed in order to ensure that the end product can be continually operated in a safe manner. These rules must be observed while using the end product and while installing the PD14/PD15 Power Supply.

5.1.1 Avoiding electrical faults

Remember that the connecting cable must never be squashed (e.g. by moving over it) during operations.

5.1.2 Ensuring operational reliability during installation

The safety and reliability of the end product containing DewertOkin components can be ensured by using the proper construction methods described below.

5.2 Installation procedure



Before installing the PD14/PD15 Power Supply, make sure that you are observing all of the safety notices found in the "Safety notices to observe during installation" section.

5.2.1 Installing the PD14/PD15 Power Supply

The PD14/PD15 Power Supply shall be used as a plug-in power supply unit.

- ▶ As an accompanying device, you should be sure that any dangers presented by the cables are described in your end-product operating manual (refer to the section "Electrical connection").

5.2.2 Electrical connections

	 CAUTION
	Electrical components should be connected or disconnected only when the power supply cord is unplugged.



	NOTICE
	There is a delay after the supply voltage is applied before the device actually turns on. Wait at least seven seconds before start up.

Routing the electrical cables

When routing the cables, be sure that:

- the cables cannot get jammed,
- no mechanical load (such as pulling, pushing or bending) will be put on the cables, and
- the cables cannot be damaged in any way.

Fasten all cables (especially the connecting cables) to the end product using sufficient kink prevention methods. Be sure that the design of the end product prevents the connecting cables from coming into contact with the floor during transport.

	<p>CAUTION</p>
	<p>Insert the power plug into the socket in an upright vertical position (as shown in Figure 8).</p>

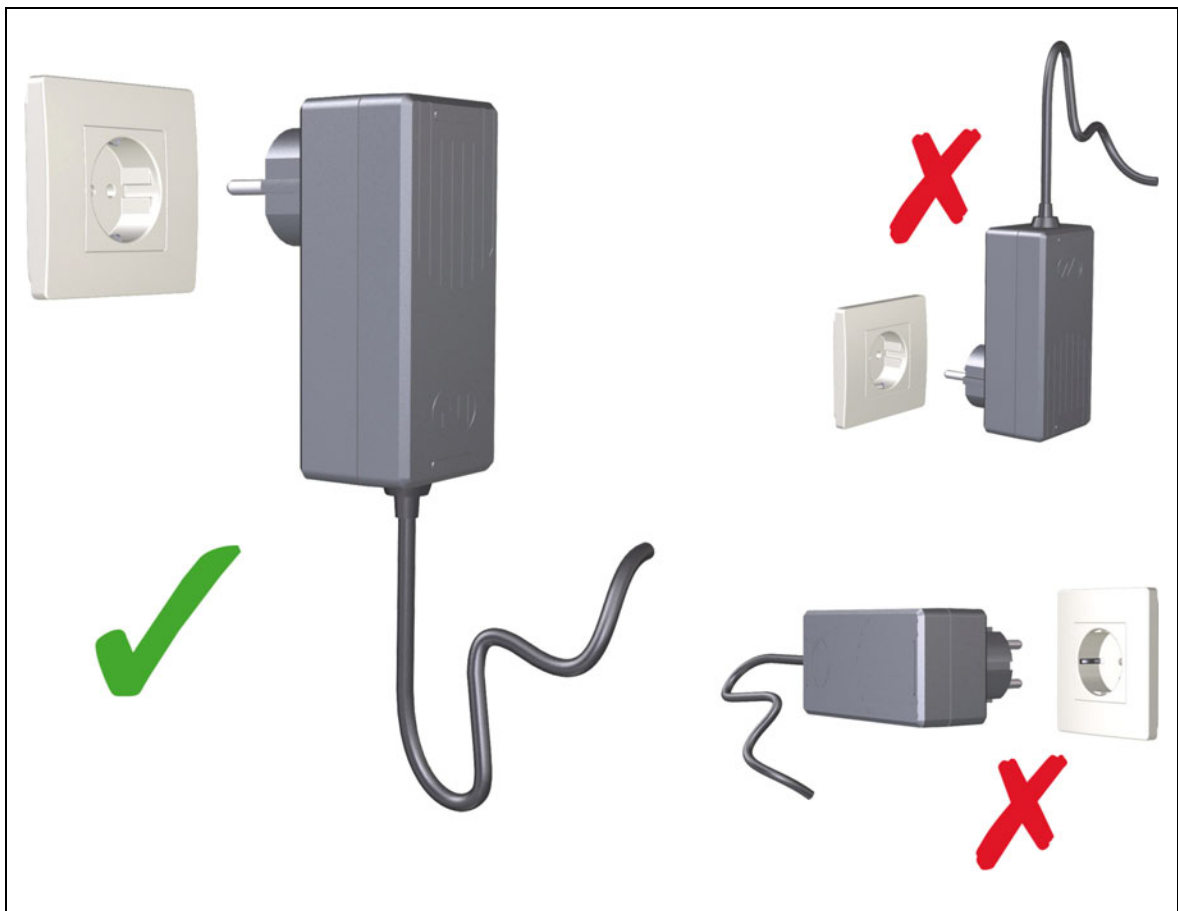



Figure 8 Position of the power plug when plugging into the power outlet

5.2.3 Connecting the drive system to the PD14/PD15 Power Supply

An LSP socket is used to connect to the control unit (as shown in Figure 5).

- 1 Disconnect the power plug from the power outlet.

	 CAUTION
	You should only connect and disconnect the cables when they are completely disconnected from any live current!



- 2 Insert the drive system's LSP plug into the LSP socket on the connection cable for the PD14/PD15 Power Supply.

After plugging the power plug into the power outlet:

	NOTICE
	There is a delay after the supply voltage is applied before the device actually turns on. Wait at least seven seconds before start up.

5.2.4 Removing the PD14/PD15 Power Supply



- 1 Disconnect the power plug from the power outlet.

	 CAUTION
	You should only connect and disconnect the cables when they are completely disconnected from any live current!

- 2 Disconnect the control unit's cable from the PD14/PD15 Power Supply.

6. Operating Notes

The factual information contained within may be used when you are creating the end-product manual. The installation instructions do not contain all information required for the safe operation of the end product. They only describe the assembly and operation of the PD14/PD15 Power Supply as a partially assembled piece of machinery.

	 CAUTION
	When creating the operating instructions, remember that the installation instructions are intended for qualified specialists and are not for typical users of the end product.

6.1 General information



- ▶ Only drive systems from DewertOkin should be connected to the PD14/PD15 Power Supply since they have already been verified to work together.



Delayed start-up

After plugging the power plug into the power outlet:



	NOTICE
	There is a delay after the supply voltage is applied before the device actually turns on. Wait at least seven seconds before start up.

Avoiding electrical risks



	 CAUTION
	Make sure that all live (current-carrying) parts of the drive system and power supply cannot be touched. In particular, be sure that unused power and control unit connections are covered adequately.

	 CAUTION
	Only use the proper power plug that is permitted in your country. Be sure to use the correct plug adapter, as described in Figure 4.

Reducing the risk of overheating with the thermal fuse



	 CAUTION
	<p>The PD14/PD15 Power Supply is equipped with a thermal monitoring mechanism that triggers when the unit overheats. If this thermal mechanism has triggered, remove the PD14/PD15 Power Supply from the power supply, allow it to rest for 20 to 30 minutes and try again. If the unit still does not function, please contact your supplier or dealer.</p>

Shutting down the connected drive system in case of emergency

	 CAUTION
	<p>In an emergency, disconnect the PD14/PD15 Power Supply from the power outlet in order to shut off the connected drive system. The power plug must always be accessible during operations so that the drive system can be shut off in an emergency.</p>



Avoiding cable damage

Be sure that your operating instructions inform the user about the possible cable risks.

	 CAUTION
	<p>The cable should not be run over. In order to prevent injuries or damage to the PD14/PD15 Power Supply, no mechanical strain should be placed on the cables.</p>



7. Troubleshooting

This chapter describes troubleshooting methods for fixing problems. If you experience an error that is not listed in this table, please contact your supplier.

	 CAUTION
	<p>Only qualified specialists who have received electrician training should carry out troubleshooting and repairs.</p>

Problem	Possible cause	Solution
The drive system is not functioning.	There is no mains supply voltage.	Connect the mains power.
	The drive system is broken.	Please contact your supplier or sales agent.
The drive system is suddenly not capable of movement.	The overheating protection or system protection has been triggered.	Remove the overload (change or remove the load). Allow the system to rest for 20 to 30 minutes with the mains power unplugged. If this does not resolve the problem, contact your supplier or distributor.
	The unit's fuse may have been triggered.	Please contact your supplier or sales agent.
	There is no mains supply voltage.	Connect the mains power.
	A supply cable (for drive system / handset) is interrupted.	Check the cables and reinsert them, if required.

8. Maintenance

	 CAUTION
	<p>You should only use replacement units which have been manufactured or approved by DewertOkin. Only these parts will guarantee a sufficient level of safety.</p>

8.1 Maintenance

Type of check	Explanation	Time interval
Check the function and safety of the electrical system.	A qualified electrician should carry out this inspection. (Refer to the "Electrical connection" section in the "Installation" Chapter.)	Periodic inspections can be carried out at intervals based on the risk assessment which you conduct for your end product.
Look over the housing periodically for any signs of damage.	Check the housing for breaks or cracks.	At least every six months.
Look over the plug-in connections and electrical access points for signs of damage.	Check that all electrical cables and connections are firmly seated and correctly positioned.	At least every six months.
Look over the cables for any signs of damage.	Check the connecting cables for pinching or shearing. Also check the strain relief and kink protection mechanisms, in particular after any mechanical load.	At least every six months.

8.2 Cleaning and care

The PD14/PD15 Power Supply was designed so that it would be easy to clean. Its smooth surfaces simplify the cleaning process.

	NOTICE
	<p>Never clean the PD14/PD15 Power Supply in an automated washing system or with a high-pressure cleaner. Do not allow fluids to penetrate into the unit. Damage to the system could result.</p> <p>Do not use a cleanser that contains benzene, alcohol or similar solvents.</p>

- 1 Be sure to unplug the PD14/PD15 Power Supply from the power outlet before you begin cleaning it!
- 2 Use a damp cloth to clean the PD14/PD15 Power Supply.
- 3 Be sure that you do not damage the connecting cables during the cleaning.

9. Disposal

9.1 Packaging material

The packaging material should be sorted into recyclable components and then disposed of in accordance with the appropriate national environmental regulations (in Germany according to the recycling law KrWG from 01.06.2012; internationally according to the EU Directive 2008/98/EC (Waste Framework Directive WFD as of 12.12.2008)).

9.2 Components in the PD14/PD15 Power Supply

The PD14/PD15 Power Supply consists of electronic components, cables and metal and plastic parts. You should observe all corresponding national and regional environmental regulations when disposing of the PD14/PD15 Power Supply.

The disposal of the end product is regulated in Germany by Elektro-G, internationally by the EU Directive 2012/19/EC (WEEE), or by any applicable national laws and regulations.



This PD14/PD15 Power Supply should not be disposed of with normal household waste!

EG-Konformitätserklärung

Nach Anhang IV der EMV-Richtlinie 2014/30/EU

Nach Anhang IV der EU-Niederspannungsrichtlinie 2014/35/EU

Nach Anhang VI der RoHS-Richtlinie 2011/65/EU (inkl. Delegierte Richtlinie (EU) 2015/863)

Der Hersteller

EU Declaration of Conformity

In compliance with Appendix IV of the EMC-Directive 2014/30/EU

In compliance with Appendix IV of the LVD-Directive 2014/35/EU

In compliance with Appendix VI of the EU RoHS Directive 2011/65/EU (incl. Commission delegated Directive (EU) 2015/863)

The manufacturer

DewertOkin GmbH
Weststraße 1
32278 Kirchlengern
Deutschland - Germany

erklärt hiermit, dass das Produkt

declares that the following product

POWER SUPPLY PD14 POWER SUPPLY PD15

die Anforderungen folgender EG-Richtlinien erfüllt:

meets the requirements of the following EU directives:

Richtlinie über elektromagnetische Verträglichkeit 2014/30/EU

Electromagnetic Compatibility Directive 2014/30/EU

Niederspannungsrichtlinie 2014/35/EU

Low Voltage Directive 2014/35/EU

DELEGIERTE RICHTLINIE (EU) 2015/863 DER KOMMISSION vom 31. März 2015 zur Änderung von Anhang II der Richtlinie 2011/65/EU des Europäischen Parlaments und des Rates hinsichtlich der Liste der Stoffe, die Beschränkungen unterliegen.

COMMISSION DELEGATED DIRECTIVE (EU) 2015/863 of 31 March 2015 amending Annex II to Directive 2011/65/EU of the European Parliament and of the Council as regards the list of restricted substances.

Angewendete Normen

Applied standards:

- EN 60335-1:2012/A11:2014
- EN 55014-1:2006/A1:2009/A2:2011
- EN 55014-2:1997/A1:2001/A2:2008
- EN 61000-3-2:2014
- EN 61000-3-3:2013
- EN 61558-2-16:2009/A1:2013
- EN 62233:2008

Konstruktive Änderungen, die Auswirkungen auf die in der Montageanleitung angegebenen technischen Daten und den bestimmungsgemäßen Gebrauch haben, das Produkt also wesentlich verändern, machen diese Konformitätserklärung ungültig!

This declaration of conformity is no longer valid if constructional changes are made which significantly change the drive system (i.e., which influence the technical specifications found in the instructions or the intended use)!

Kirchlengern, Germany 25 November 2019



Dr.-Ing. Josef G. Groß
Geschäftsführer / Managing Director

Additional information

The following standards have been used – according to IEC 60601-1, third edition, EN 60601-1, third edition:

EN60601-1, Section 4	General requirements
EN60601-1, Section 6	Classification
EN60601-1, Section 7.1	Labelling – general
EN60601-1, Section 7.2	Labelling – inscriptions
EN60601-1, Section 8	Protection against electrical danger
EN60601-1, Section 11.1	Overheating protection
EN60601-1, Section 11.2	Fire prevention
EN60601-1, Section 11.3	Design requirements for damp housings
EN60601-1, Section 13	Dangerous situations and error conditions
EN60601-1, Section 15.3	Mechanical attachment
EN60601-1, Section 15.4	Components and general construction
EN60601-1, Section 15.4.4	Replaced by EN60601-2-52, Section 201.15.4.4
EN60601-1, Section 16.6	Leakage current
EN60601-1, Section 17	Electromagnetic compatibility
EN 60601-2-52, Section 201.6.2	Protection against electrical shock: Protection class II
EN60601-2-52, Section 201.6.5.101	Protection against water ingress: only applied for at least IPX4
EN 60601-2-52, Section 201.15.4.4	Displays: Ready indicator is not required



DEWERT OKIN

A DewertOkin Technology Group Company

DewertOkin GmbH
Weststraße 1
32278 Kirchlengern, Germany
Tel: +49 (0)5223/979-0
Fax: +49 (0)5223/75182
<http://www.dewertokin.de>
Info@dewertokin.de

ID-Nr.: 77346