



MCL III Control Unit

Installation Instructions

(Translation of the original installation instructions)

Foreword

Document revision history

Version	Date	Modification, change
(-)	10/15	First release

Disclaimer and exclusion of liability

DewertOkin is not responsible for damage resulting from:

- failure to observe these instructions,
- changes made to this product which have not been approved by DewertOkin, or
- the use of replacement parts which have not been approved or manufactured by DewertOkin.

Manufacturer's address

DewertOkin GmbH
 Weststraße 1
 32278 Kirchlengern
 Germany
 Tel: +49(0)5223/979-0
 Fax.: +49 0 522375182
<http://www.dewertokin.de>
Info@dewertokin.de

Creation of a complete operating instruction manual for the entire end product

These instructions are only intended to be used by the end-product manufacturer. They should not be given to the operator of the end product. The factual information contained within may be used as a basis when creating the end-product manual.

The warning and danger notices are best suited for use in the end product's manual. However it is not sufficient to simply follow these notices. You should also carry out an internal risk assessment for your end product. This can then be used as the basis for the safety notices in your manual.

Usage in medical products

The MCL III control unit is not a medical product. If used in a medical end product, you (the end manufacturer) are obliged to ensure compliance with EC directives and to ensure that other pertinent medical product regulations are maintained.

Notice for customers in EU nations

TÜV inspection label

German Inspection Authority (TÜV SÜD Product Service) testing label

The construction of the MCL III control unit has been inspected by the German TÜV SÜD Product Service Inspection Authority. The TÜV SÜD Product Service also monitors the production of the PD12/PD13 POWER SUPPLY. The official German TÜV SÜD Product Service certifies this construction inspection and production monitoring.



Figure 1 TÜV SÜD Product Service Safety Mark

Table of contents

Foreword	3
Document revision history	3
Disclaimer and exclusion of liability	3
Manufacturer's address	3
Creation of a complete operating instruction manual for the entire end product	3
Usage in medical products	3
Notice for customers in EU nations	4
Table of contents	5
1. General Information	7
1.1 About these installation instructions	7
1.2 Conventions used	7
2. Safety notices	8
2.1 Proper and intended usage	8
2.2 Selection and qualification of personnel	9
2.3 Notice on safety during operations	9
2.4 Product labelling	10
3. Possible combinations	11
3.1 Layout of system connections	11
4. Description	12
4.1 Components	12
5. Technical specifications	14
6. Installation	16
6.1 Safety notices to observe during installation	16
6.2 Installation procedure	17
7. Operating notes	23
7.1 General information	23
7.2 Notice for operating with optional configuration	24
8. Troubleshooting	25



9.	Maintenance	26
9.1	Maintenance	26
9.2	Cleaning and care	27
10.	Disposal	28
10.1	Packaging material	28
10.2	Components in the MCL III control unit	28
	EU Declaration of Conformity	29
	Additional information	30

1. General Information

1.1 About these installation instructions

In order to install the MCL III control unit successfully and safely in the end product, these installation instructions must be observed. These instructions are not an operating manual for the end product.

These instructions will help you to minimize danger, repair costs and down times. They will also help you to maximize the reliability and lifespan of the end product.

 CAUTION
 <p>The notices in these instructions must be followed! Following the guidelines during installation and connection procedures will help to minimize:</p> <ul style="list-style-type: none"> • the risk of accident and injury, and • damage to the MCL III control unit or the end product.

These installation instructions have been written with due care and attention. However, we cannot guarantee that the data, images and drawings are complete and correct nor do we accept any liability for the information contained therein, unless required by law.



- ▶ We reserve the right to make unannounced technical changes in the course of our continual product improvement process!



1.2 Conventions used



Notices which do not relate to safety are indicated in these instructions with a symbol:

- ▶ Triangular notice symbol

Explanations of warning notices

 WARNING
 <p>WARNING indicates a hazardous situation which, if not avoided, could result in death or serious injury.</p>

 CAUTION
 <p>CAUTION indicates a hazardous situation which, if not avoided, could result in minor or moderate injury.</p>



 NOTICE
 <p>NOTICE is used to address practices which are not related to personal injury but may result in damage to the product or surroundings.</p>

2. Safety notices

2.1 Proper and intended usage



The MCL III control unit is intended to be used as a control unit and power supply for the appropriate DewertOkin drive systems in use



- for care purposes,
- or in hospitals.

 CAUTION
<div style="display: flex; align-items: center;">  <div> <p>The MCL III control unit should only be used for the applications described above. Any other use is forbidden. Improper usage can lead to accidents or destruction of the unit. Such non-approved applications will lead immediately to the expiration of all guarantee and warranty claims on the part of the end-product manufacturer against the manufacturer.</p> </div> </div>

2.1.1 Improper usage

Be sure to follow the notices below concerning improper usage. You should include them in your product manual in order to inform the users of your end product.

 WARNING
<div style="display: flex; align-items: center;">  <div> <p>The MCL III control unit should not be used:</p> <ul style="list-style-type: none"> • in any environment where combustible or explosive gases or vapours (e.g., anaesthesiology) may be present, • in the proximity of open fires or other heat sources (such as furnaces, ovens or direct sunlight), • as a power source for toys or games, • in any application that will be cleaned with an automated washing system, • in a moist environment, or • outdoors. </div> </div>

 CAUTION
<div style="display: flex; align-items: center;">  <div> <p>The MCL III control unit may not be operated by:</p> <ul style="list-style-type: none"> • by small children, • by frail or infirm persons without supervision, or • in the proximity of small children. </div> </div>

The MCL III control unit can be used by children of 8 years and older, persons with reduced physical, sensory or mental capabilities, or persons with lack of experience or knowledge when they are supervised or instructed concerning the safe use of the device and when they understand the resulting risks. Do not allow children to play with this device. The cleaning and user maintenance must not be carried out by children without supervision.

- ▶ You should only use spare parts which have been manufactured or approved by DewertOkin. Only these parts will guarantee a sufficient level of safety.

Using the drive systems in medical applications

This DewertOkin product complies with the safety requirements found in IEC 60601-1.

We strongly recommend that the end product (including all its components) which you are manufacturing for a medical application should also comply with the safety requirements found in IEC 60601-1.

You should make sure that the mechanical movement of the motor in your end product poses no risk of injury. Conduct a risk analysis for the end product for this purpose. You should also include safety notices in the instructions for the end product and technical safeguards in your product to eliminate any risk.

2.2 Selection and qualification of personnel

This MCL III control unit should only be installed into the end product by someone who has completed training in electronic motor assembly or has equivalent qualifications.

You should only install the MCL III control unit when you are qualified to do so. Otherwise, a properly qualified person should be found for this task.

2.3 Notice on safety during operations

Basic safety rules must be followed in order to ensure that the end product can be continually operated in a safe manner. These rules must be observed while using the end product and while installing the MCL III control unit.

These rules and safety measures can be categorized as follows:

- Construction measures before the installation (refer to the "Ensuring operational reliability during installation" section in the "Installation" Chapter)
- Safety fundamentals during the installation of the MCL III control unit and during cable and wire routing (refer to the "Electrical connection" section in the "Installation" Chapter)
- Basic safety rules during operation (refer to the "Operating notes" Chapter).
- The creation of a manual for the end product which contains these and other safety rules.

2.3.1 Creating a user's manual

The manufacturer of the end product must create a manual for the users of that product. The safety notices in the end-product manual must be written based on the end product's risk assessment.

2.3.2 Electrical safety

	CAUTION
	Be careful; there is a risk of electrical shock! Be sure to unplug the power cord on the MCL III control unit before you begin assembly!

The MCL III control unit should not be opened! You must properly dispose of malfunctioning or broken units.

2.4 Product labelling

2.4.1 Ratings plate

A ratings plate (or type label) on each MCL III control unit specifies the exact name and serial number of the drive. It also states the technical specifications valid for that particular control unit. The following illustration shows where the specifications are located on the ratings plate of the MCL III control unit.

- ▶ The ratings plate shown is an example. The specifications for the MCL III control unit may differ from this illustration.

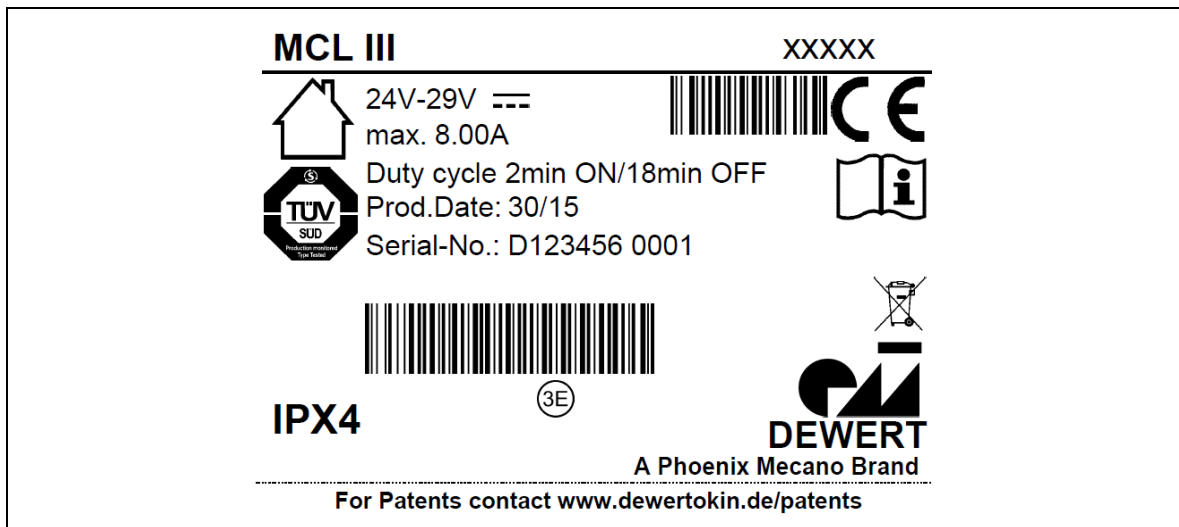





Figure 2 Ratings plate example for the MCL III control unit

MCL III	Model name
xxxxxx	Article number
24V – 29V ~	Input voltage
Max. 8.00A	Current consumption
Duty cycle: 2min ON / 18min OFF	Intermittent operations: 2 minutes / 18 minutes
Prod.date	Calendar week / year
Serial-No.	Serial number of the MCL III control unit
IPX4	Protection degree
	Standards label: refer to additional information
	Use in dry rooms only!
	Follow all special disposal instructions!
	Conformity mark

3. Possible combinations

The MCL III control unit can be combined with one or more drives. The following basic combinations are possible:

- one drive (e.g. Megamat MCZ, MFZ or MXS) with a handset attached to the MCL III control unit,
- one drive (e.g. Megamat MCZ, MFZ or MXS) and up to three further single drives with a handset attached to the MCL III control unit,
- an additional Supervisor, Control Box or short-circuit plug can optionally be connected,
- an optional connection for a rechargeable battery.

Systems can be customized by combining drives, control units, handset and batteries as needed.

DewertOkin has separate system instruction manuals containing the additional information and instructions needed for these systems. You can also find more information at www.dewertokin.de.

3.1 Layout of system connections

Refer to the sticker on the control unit for details about layout and positioning of the connections. The sticker is located above the sockets. It indicates the proper type of connections. The layout of the connection scheme is individual and depends on the system specifications. Figure 3 This is only an example and shows you where the label is attached.



Figure 3 An illustration of where the connection layout sticker is positioned on the control unit

A Layout of connections



NOTICE

Only connect the components according to the specifications found on the sticker on the control unit. Any other arrangement of connections may damage the control unit.

4. Description

The MCL III control unit is used for power supply and control for one or more DewertOkin drives. The connecting cable is used to connect the MCL III control unit to the power supply (e.g. a PD15).

- ▶ We reserve the right to make unannounced technical changes in the course of our continual product improvement process!

4.1 Components

The housing of the MCL III control unit has a connection for the power feed-in and connections for the drives, handset and accessories (e.g. battery). The connection for the drive/handset is fitted with a covering mechanism to guard against accidental unplugging.

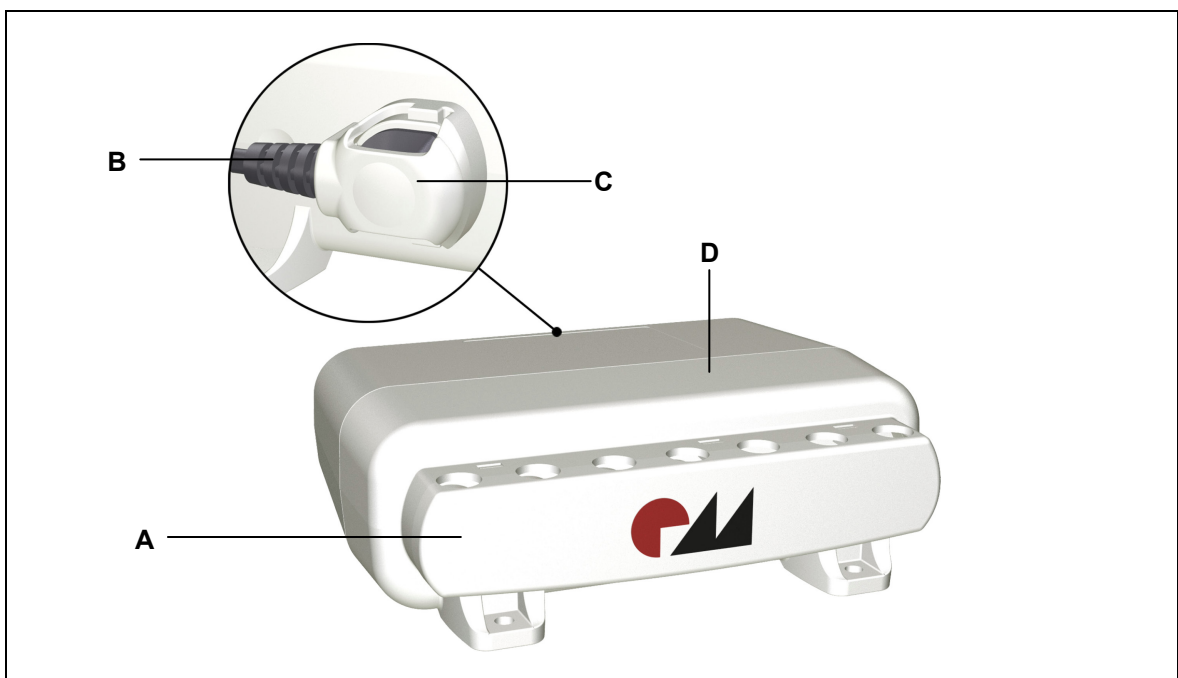

Figure 4 Components for the MCL III control unit

- | | |
|---|---|
| A Cover over the connecting cables | B Connecting cable to the power supply (e.g. PD15) |
| C Locking cap (fixed in position) | D MCL III control unit |

4.1.1 Drives with a fixed cap covering the electrical access

The following symbol can be found on the MCL III control unit's locking cap.



This symbol indicates that the unit should only be opened by qualified specialists!

4.1.2 Connectors



Figure 5 LSP plug to the connecting cable

A Connecting cable to the power supply (e.g. PD15) **B** LSP plug

5. Technical specifications

Input voltage	24 - 29 VDC
Current consumption at nominal operations	Max. 8 A
Mode of operations ¹⁾	Intermittent duty 2 min./18 min.
Protection class	III
Permitted current consumption of all additional drives ²⁾	Max. 8 A (depending on version)
Protection degree	IPX4
Colours	Grey
Dimensions and weight	
Length x width x height	165 mm x 143 mm x 56 mm
Weight	Approx. 500 g
Ambient conditions for operation, storage and transport	
Transport / storage temperature	From -20 °C to +50 °C From -4 °F to +122 °F
Operating temperature	From +10 °C to +40 °C From +50 °F to +104 °F
Relative humidity	From 30% to 75%
Air pressure	From 800 hPa to 1060 hPa
Height	< 2000 m

¹⁾ Mode of operation: intermittent duty 2 min/18 min. This means that after the unit is operated with its rated load for up to two minutes it must then be paused for 18 minutes. The system can malfunction if this pause is not observed!

²⁾ No more than two drives may be operated at rated load simultaneously!

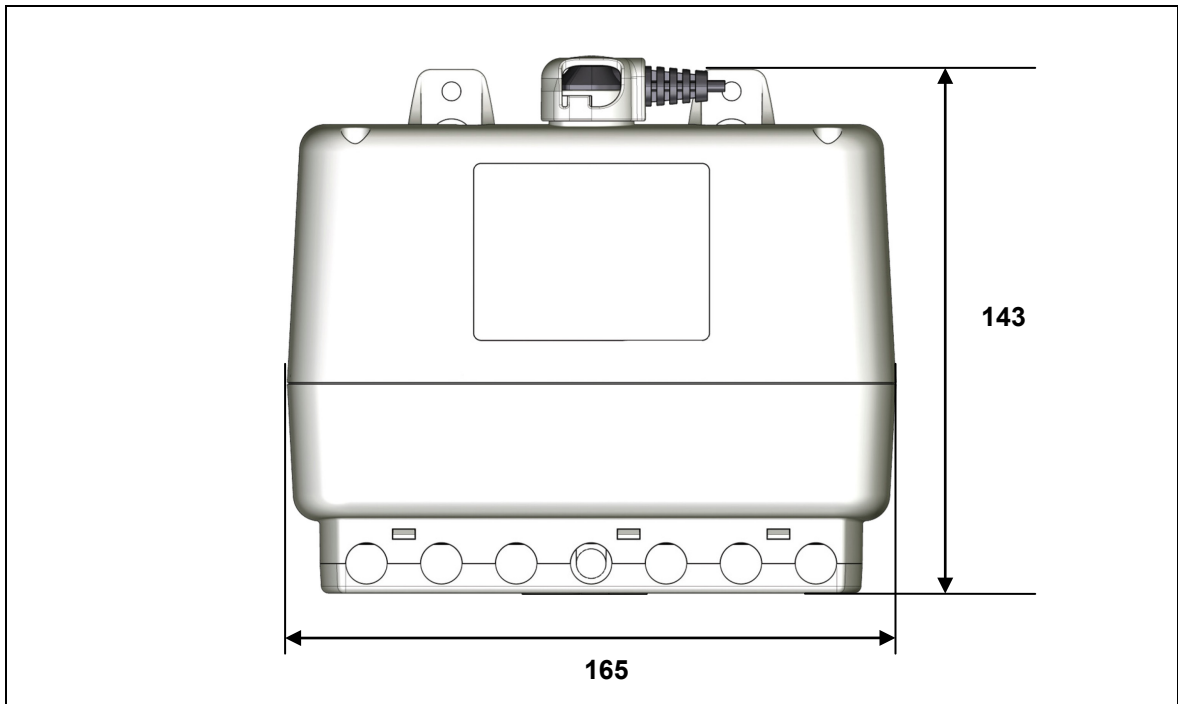

Figure 6 Dimensions of the MCL III control unit, top view (in mm)



Figure 7 Dimensions of the MCL III control unit, front view (in mm)

6. Installation

6.1 Safety notices to observe during installation

Basic safety rules must be followed in order to ensure that the end product can be continually operated in a safe manner. These rules must be observed while using the end product and while installing the MCL III control unit.

6.1.1 Avoiding electrical faults

The connecting cable is designed to connect the power supply through the (PD15) power supply. When sizing your end product, remember that the connecting cable must never be squashed (e.g. by moving over it) during operations.

6.1.2 Ensuring operational reliability during installation

The safety and reliability of the end product containing DewertOkin components can be ensured by using the proper construction methods described below.

Mechanical construction

A plug cover protects the connections from mechanical damage and minimizes the risk of accidental unplugging.

6.2 Installation procedure

Before installing the MCL III control unit, make sure that you are observing all of the safety notices found in the "Safety notices to observe during installation" section.

6.2.1 Installation and dismantling for the control unit

There are four mounting holes in the MCL III control unit which can be used to attach it to the end product with the appropriate screws (for example, 4.5 mm x 30 mm screws: DIN 7981). The MCL III control unit should be mounted so that it lies flat against its supporting material. In the end product, no mechanical forces (such as torsion) should be put on the MCL III control unit or its housing. Such forces could lead to damage (such as cracks) in the housing.

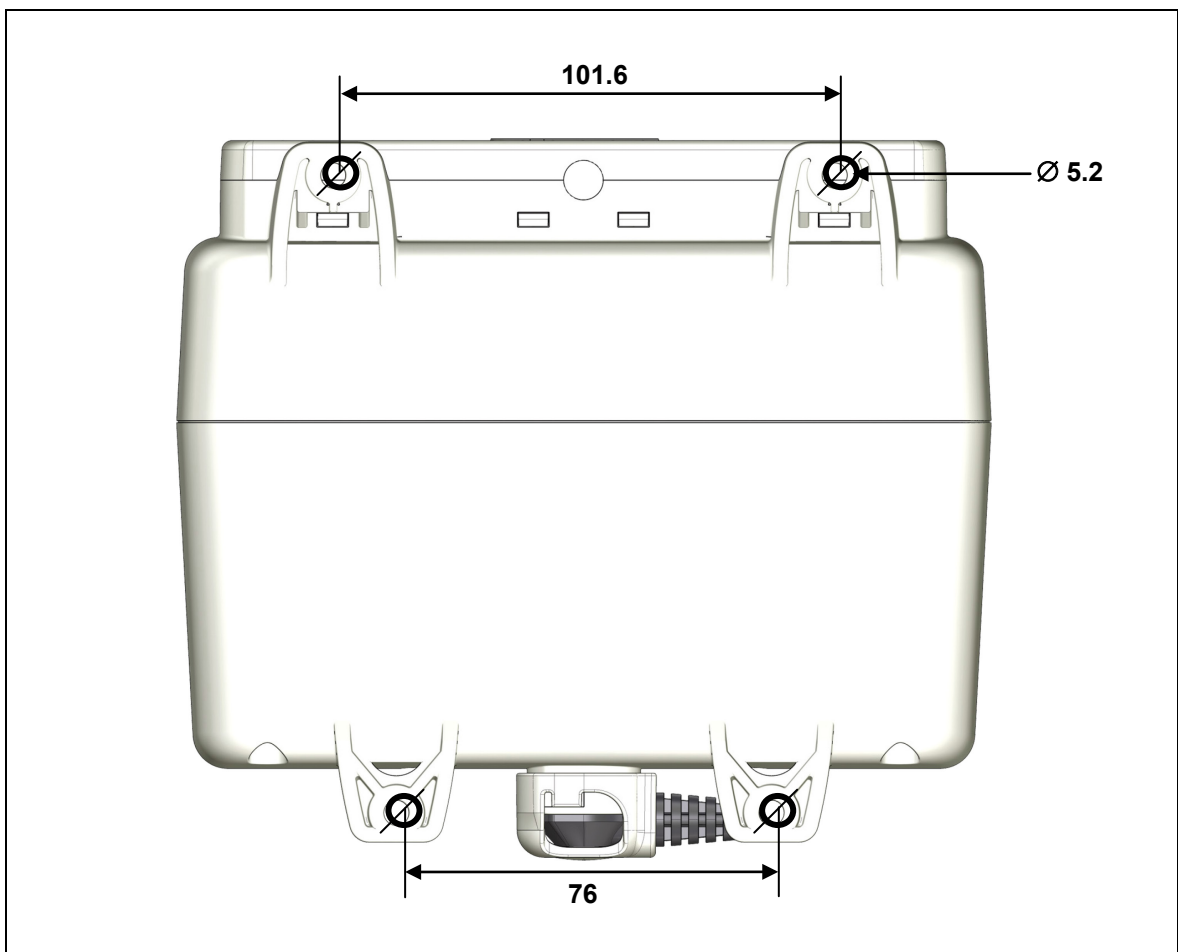

Figure 8 MCL III control unit mounting points (in mm)

Option: Installing the strain relief cable grip for the MCL III control unit on the end product

The strain relief for the MCL III control unit's power cable is installed on the end product as shown in Figure 9.

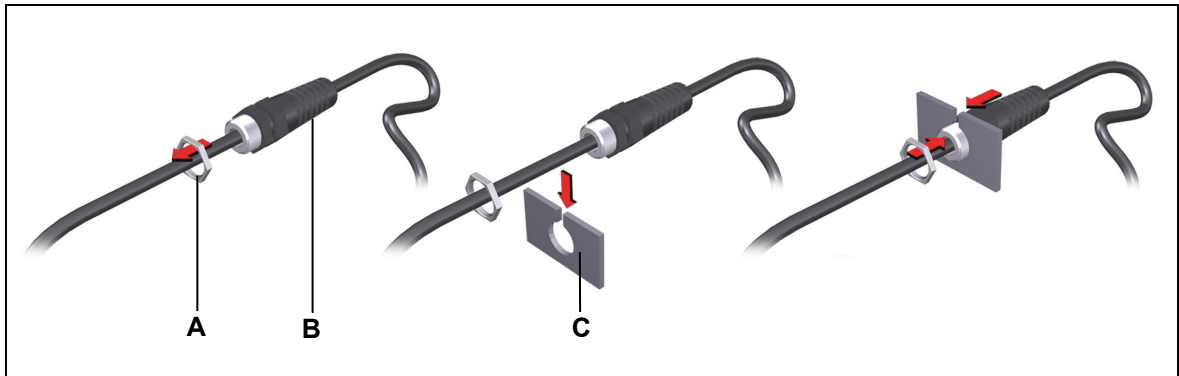

Figure 9 Mounting the strain relief cable grip (an example application)

A Hex nuts

B Strain relief

C End product (with slot for cable entry) that the strain relief mechanism will be attached to.

- 1 Unscrew the flat hex nut (**A**).
- 2 Insert the strain relief (**B**) through the slot in the hole in the end product (**C**).
- 3 Tighten the hex nut (**A**) back onto the strain relief cable grip.

Option: Route the connecting cable through the MCL III control unit's strain relief cable grip.

The method for routing the connecting cable through the cable grip of the MCL III control unit is shown in Figure 10.

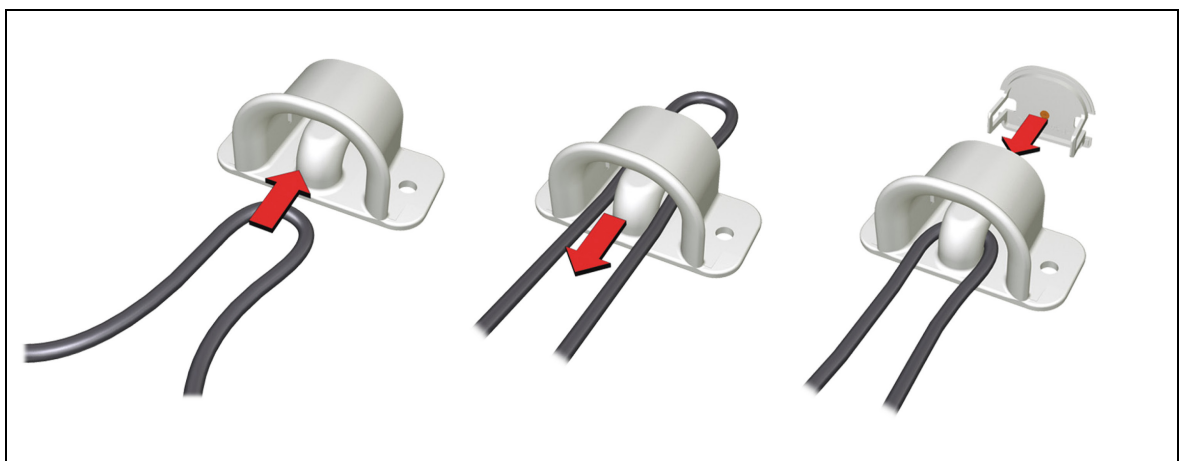





Figure 10 Routing the connecting cable through the mounted cable grip

- 1 Take a loop of the connecting cable and guide it through the strain relief cable grip, as shown in Figure 10.
- 2 Pull the cable slightly forward.
- 3 Put the cap onto the cable grip. The cap must snap on properly.

6.2.2 Electrical connection

	 CAUTION
	Electrical components should be connected or disconnected only when the power supply cord (connecting cable) is unplugged.

	NOTICE
	There is a delay after the supply voltage is applied before the device actually turns on. Wait at least seven seconds before beginning the commissioning.

Routing the electrical cables

When routing the cables, be sure that:

- the cables cannot get jammed,
- no mechanical load (such as pulling, pushing or bending) will be put on the cables, and
- the cables cannot be damaged in any way.

Fasten all cables (especially the connecting cables) to the end product using sufficient kink prevention methods. Be sure that the design of the end product prevents the connecting cables from coming into contact with the floor during transport.

Connecting the drives to the MCL III control unit

The electrical connection from the drive to the MCL III control unit is made by plugging the drive plug into the MCL III control unit.

Take off the cover (refer to the following section) and plug the drive plug into the proper socket.

Opening the shield cover

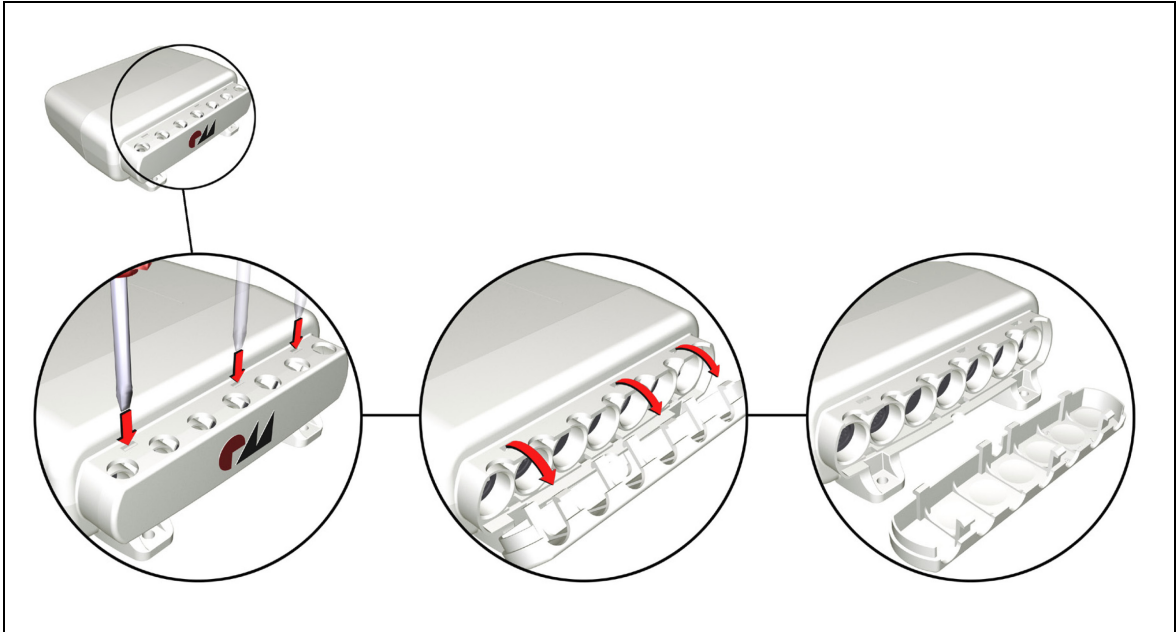



Figure 11 Opening the shield cover on the MCL III control unit

- 1 Pull out the mains plug from the outlet.

	 CAUTION
<p>You should only connect and disconnect the cables when they are completely disconnected from any live current!</p>	

- 2 Use a suitable tool to press the three locking clips down in the notches as shown in Figure 11. At the same time, tilt the shield cover forward so that the clips come out of the notches.
- 3 Remove the shield cover.
- 4 You can now connect or disconnect a plug and socket. Be sure to use the proper socket. (The assignments of plugs to sockets is shown in the connection layout diagram. (Figure 3 shows the connection positions.)

Connecting the MCL III control unit to the PD15 power supply

The power cable between the MCL III control unit and the PD15 power supply is connected as shown in Figure 12.

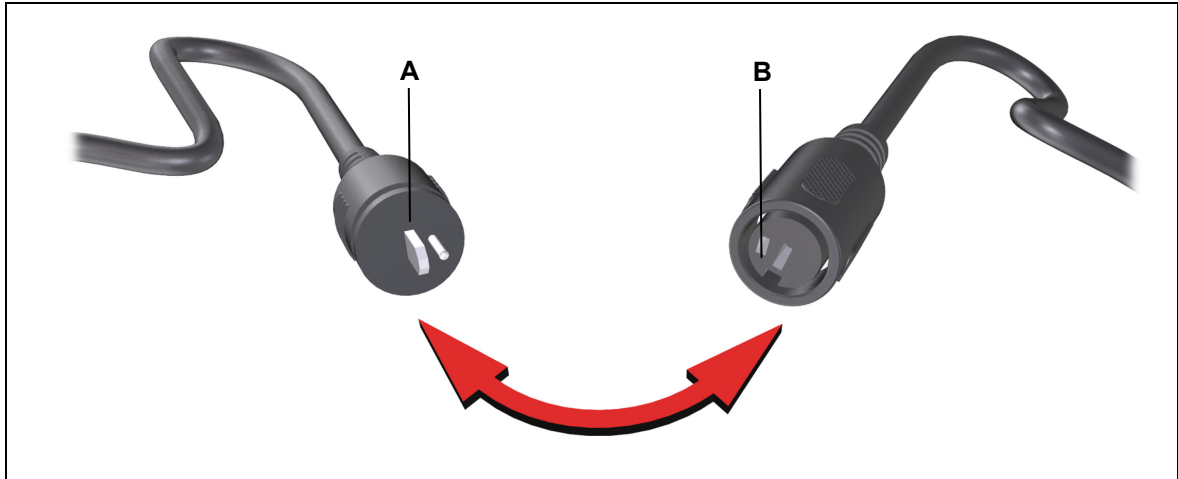



Figure 12 Connecting the MCL III control unit to the PD15 power supply

A LSP plug from the MCL III control unit

B LSP socket for the PD15 power supply

	 CAUTION
	<p>Electrical components should be connected or disconnected only when the mains power plug and the battery plug (when present) are both unplugged.</p>

6.2.3 Connecting the optional battery

An external rechargeable battery can be connected to the optional battery socket. The sticker above the sockets shows the position of the battery socket (refer to the "Layout of system connections" section in the "Possible combinations" chapter).

- 1 Disconnect the PD15 power supply from the socket or disconnect the MCL III cable from the PD15 power supply.
- 2 Use a suitable tool to press the three locking clips down into the notches as shown in Figure 11. At the same time, tilt the shield cover forward so that the clips come out of the notches.
- 3 Remove the shield cover.
- 4 Insert the battery plug into the battery socket on the MCL III control unit. Be sure to use the proper socket (the assignments of plugs to sockets is shown in the connection layout diagram). Figure 3 in the "Possible combinations" chapter shows the connection positions.
- 5 Push the shield cover on until the locking clips snap into the notches.
- 6 Reconnect the PD15 power supply to the socket and reconnect the MCL III cable to the PD15 power supply.



6.2.4 Connecting the optional, additional Supervisor or Control Box

The Supervisor or the Control Box can be connected to the optional Supervisor socket. The sticker above the sockets shows the position of the Supervisor socket (refer to the "Layout of system connections" section in the "Possible combinations" chapter).

- 1 Disconnect the PD15 power supply from the socket or disconnect the MCL III cable from the PD15 power supply.
- 2 Use a suitable tool to press the three locking clips down into the notches as shown in Figure 11. At the same time, tilt the shield cover forward so that the clips come out of the notches.
- 3 Remove the shield cover.
- 4 Insert the Supervisor, Control Box or short-circuit plug in the Supervisor socket of the MCL III control unit. Be sure to use the proper socket (the assignments of plugs to sockets in shown in the connection layout diagram). Figure 3 in the "Possible combinations" chapter shows the connection positions.
- 5 Push the shield cover on until the locking clips snap into the notches.
- 6 Reconnect the PD15 power supply to the socket and reconnect the MCL III cable to the PD15 power supply.

6.2.5 Removing the MCL III control unit



- 1 Disconnect the PD15 power supply from the socket or disconnect the MCL III cable from the PD15 power supply.

	 CAUTION
	You should only connect and disconnect the cables when they are completely disconnected from any live current!

- 2 Open and remove the cover (refer to Figure 11).
- 3 Disconnect all connecting cables from the MCL III control unit.

7. Operating notes

The factual information contained within may be used when you are creating the end-product manual. The installation instructions do not contain all information required for the safe operation of the end product. They only describe the assembly and operation of the MCL III control unit as a partially assembled piece of machinery.

	 CAUTION
	When creating the operating instructions, remember that the installation instructions are intended for qualified specialists and are not for typical users of the end product.

7.1 General information



- ▶ Only DewertOkin's Megamat MCZ, MFZ or MXS drives should be connected to the MCL III control unit since they have already been verified to work together.

Power-on time / intermittent operations



The MCL III control unit has been designed for intermittent operations. Intermittent operation is an operational mode where the drive must pause after a specified maximum period of operation (power-on time). This protects the drive from overheating. Extreme overheating can cause a malfunction.

- ▶ The ratings plate specifies the maximum power-on time and the required pause intervals.

Avoiding electrical risks



	 CAUTION
	Make sure that no live (current-carrying) parts of the drive system and power supply can be touched. In particular, be sure that unused power and control unit connections are covered adequately.

Emergency shut off of a connected drive or control unit

	 CAUTION
	Be sure to unplug the PD15 power supply from the power outlet before you begin cleaning it! This power outlet must be accessible at all times during operation so that the cable can be unplugged. Or you can disconnect the plug on the MCL III control unit from the PD15 power supply. This will shut down the connected drive. If the optional battery is connected, disconnect the battery plug from the socket on the MCL III control unit.

Avoiding cable damage

Be sure that your operating instructions inform the user about the possible cable risks.

	 CAUTION
	<p>The cables (particularly the connecting cable) should not be run over. In order to prevent injuries or damage to the drive and MCL III control unit, no mechanical strain should be placed on the cables.</p>

7.2 Notice for operating with optional configuration

7.2.1 Optional: Rechargeable battery with no integrated charging circuitry

If you have purchased an MCL III with no integrated charging circuitry then note the information below when operating with the optional external battery:

- Load the battery for at least 24 hours before first use.
- Use a suitable Dewert-OKIN charger to charge the battery. Follow the instructions that come with the battery charger!
- The battery charge status is displayed on the handset when the handset is equipped with a battery display:
 - The battery is being loaded when the battery control light is blinking.
 - The battery is ready when the unit is plugged into the mains and the battery control light is continuously illuminated.
- After you have used the battery-operated reset function, be sure to charge the battery until the ready signal is displayed (the battery control light, when present, stays illuminated).
- ▶ Follow the additional information found in the rechargeable battery information sheet (ID No. 45564).



7.2.2 Optional: rechargeable battery with integrated charging circuitry

If you have purchased the MCL III with the integrated charging circuitry and external battery, then you should note the following:

- Load the battery for at least 24 hours before first use.
- The battery charge status is displayed on the handset when the handset is equipped with a battery display:
 - The battery is being loaded when the battery control light is blinking.
 - The battery is ready when the unit is plugged into the mains and the battery control light is continuously illuminated.
- Optional: A warning tone is issued when the battery charge is low. Shortly after the tone, the battery is switched off so that it cannot be damaged by a drain discharge.
- After you have used the battery-operated reset function, be sure to charge the battery until the ready signal is displayed (the battery control light, when present, stays illuminated). The integrated charging circuitry in the MCL III control unit controls the charge automatically.
- ▶ Follow the additional information found in the rechargeable battery information sheet (ID No. 45564).

8. Troubleshooting

This chapter describes troubleshooting methods for fixing problems. If you experience an error that is not listed in this table, please contact your supplier.

	 CAUTION
	<p>Only qualified specialists who have received electrician training should carry out troubleshooting and repairs.</p>

Problem	Possible cause	Solution
The drive or control unit is not functioning.	There is no mains supply voltage.	Connect the mains power.
	The drive or control unit is defective.	Please contact your supplier or sales agent.
The drive is suddenly not capable of movement.	The overheating protection or system protection has been triggered.	Remove the overload (change or remove the load). Allow the system to rest for 20 to 30 minutes with the mains power unplugged. If this does not resolve the problem, contact your supplier or distributor.
	The unit's fuse may have been triggered.	Please contact your supplier or sales agent.
	There is no mains supply voltage.	Connect the mains power.
	A cable has been disconnected (to mains power, drive or control keypad).	Check the cables and reinsert them, if required.

9. Maintenance

- ▶ You should only use spare parts which have been manufactured or approved by DewertOkin. Only these parts will guarantee a sufficient level of safety.

9.1 Maintenance

Type of check	Explanation	Time interval
Check the function and safety of the electrical system.	A qualified electrician should carry out this inspection. (Refer to the "Electrical connection" section in the "Installation" Chapter.)	Periodic inspections can be carried out at intervals based on the risk assessment which you conduct for your end product.
Look over the housing periodically for any signs of damage.	Check the housing for breaks or cracks.	At least every six months.
Look over the plug-in connections and electrical access points for signs of damage.	Check that all electrical cables and connections are firmly seated and correctly positioned.	At least every six months.
Look over the cables for any signs of damage.	Check the connecting cables for pinching or shearing. Also check the strain relief and kink protection mechanisms, in particular after any mechanical load.	At least every six months.
Check periodically to see if the rechargeable battery is ready and operational. (Battery is optional)	If you can no longer move the drive in both directions with a fully charged battery, then you should replace the battery.	At least every four weeks.

9.2 Cleaning and care

The MCL III control unit is easy to clean. Its smooth surfaces simplify the cleaning process.

	NOTICE
	Never clean the MCL III control unit in an automated washing system or with a high-pressure cleaner. Do not allow fluids to penetrate the lighting. Damage to the system could result. Do not use a cleanser that contains benzene, alcohol or similar solvents.

- 1 Be sure to unplug the PD15 power supply unit's power cord before you begin cleaning.

	CAUTION
	For the optional rechargeable battery: Disconnect the battery plug from the socket on the MCL III control unit.

- 2 Clean the MCL III control unit with a moist cloth.
- 3 Be sure that you do not damage the connecting cables during the cleaning.

10. Disposal

10.1 Packaging material

The packaging material should be sorted into recyclable components and then disposed of in accordance with the appropriate national environmental regulations (in Germany according to the recycling law KrWG from 01.06.2012; internationally according to the EU Directive 2008/98/EC (Waste Framework Directive WFD as of 12.12.2008)).

10.2 Components in the MCL III control unit

The MCL III control unit consists of electronic components, cables and metal and plastic parts. You should observe all corresponding national and regional environmental regulations when disposing of the system.

The disposal of the end product is regulated in Germany by Elektro-G, internationally by the EU Directive 2011/65/EC (RoHS), or by any applicable national laws and regulations. (The end product is not regulated by the EU Directive 2012/19/EC (WEEE).)



The MCL III control unit should not be disposed of with normal household waste!

EU Declaration of Conformity

In compliance with Appendix IV of the EU EMC Directive 2004/108/EC
In compliance with Appendix III of the EU Low Voltage Directive 2006/95/EC
In compliance with Appendix VI of the EU RoHS Directive 2011/65/EU

The manufacturer:
DewertOkin GmbH
Weststraße 1
32278 Kirchlengern
Germany

declares that the following product

MCL III control unit

meets the requirements of the following EU directives:

Electromagnetic Compatibility Directive 2004/108/EC

Low Voltage Directive 2006/95/EC

RoHS Directive 2011/65/EU of the European Parliament and of the Council of 8 June 2011 on the restriction of the use of certain hazardous substances in electrical and electronic equipment

Applied standards:

- EN 60335-1:2013
- EN 55014-1/A2:2011
- EN 55014-2/A2:2008
- EN 61000-3-2/A2:2009
- EN 61000-3-3:2013
- EN 62233:2008

This declaration of conformity is no longer valid if constructional changes are made which significantly change the product (i.e., which influence the technical specifications found in the instructions or the intended use)!

Kirchlengern, Germany. The 27.October 2015



Dr.-Ing. Josef G. Groß
Managing Director

Additional information

In accordance with the EN 60601-1:2006, "Electrical medicinal devices", the following standards are used: **3E** – refer to the ratings plate for this label):

EN 60601-1, Section 4	General requirements
EN 60601-1, Section 6	Classification
EN 60601-1, Section 7.1	Labelling – general
EN 60601-1, Section 7.2	Labelling – inscriptions
EN60601-1, Section 8	Protection against electrical danger
EN60601-1, Section 11.1	Overheating protection
EN60601-1, Section 11.2	Fire prevention
EN60601-1, Section 11.3	Design requirements for fire-resistant housing
EN60601-1, Section 13	Dangerous situations and error conditions
EN60601-1, Section 15.3	Mechanical attachment
EN60601-1, Section 15.4	Components and general construction
EN60601-1, Section 15.4.4	Replaced by EN 60601-2-52, section 201.15.4.4
EN60601-1, Section 16.6	Leakage current
EN60601-1, Section 17	Electromagnetic compatibility

In accordance with EN 60601-2-52:2010, "Particular requirements for the safety and essential performance of medical beds", the following standards have been used (label:  – refer to the ratings plate for this label):

EN 60601-2-52, Section 201.6.2	Protection against electrical shock: Protection class II
EN 60601-2-52, Section 201.7.6.3	Control panel symbols (depending on model, customer requirements)
EN 60601-2-52, Section 201.9.2.2.5	Operating device with automatic reset function (e.g. IPROXX)
EN 60601-2-52, Section 201.9.2.3.1	Unintentional movement: Prevented by means of a locking mechanism (such as Control box, Supervisor, IPROXX [®] SE, IPROXX [®] , or Meditouch)
EN 60601-2-52, Section 201.11.1.1	Temperatures
EN 60601-2-52, Section 201.11.6.5.101	Waterproof protection
EN 60601-2-52, Section 201.11.8	Loss of power: e.g. use of a battery, depending on customer requirements
EN 60601-2-52, Section 201.13.1.4	Special mechanical risks, depending on customer requirements: Prevented by means of a locking mechanism (such as Control box, Supervisor, IPROXX [®] SE, IPROXX [®] , or Meditouch)
EN 60601-2-52, Section 201.15.3.4.1	Mechanical strength – handset (e.g. IPROXX)
EN 60601-2-52, Section 201.15.4.4	Displays: Ready indicator is not required
EN 60601-2-52, Section BB.3.3.3	Dimensions (depending on version and customer requirements) – handset (e.g. IPROXX)
EN 60601-2-52, Section BB.3.4.1	Operational forces – handset (e.g. IPROXX)

DewertOkin GmbH
Weststraße 1
Kirchlengern 32278, Germany
Tel: +49(0)5223/979-0
Fax.: +49 0 522375182
<http://www.dewertokin.de>
Info@dewertokin.de

ID No.: 82700