



# PD24 POWER SUPPLY

## Installation Instructions

(Translation of the original installation instructions)



# Foreword

## Document revision history

Version	Date	Modification, change
1.0	01/20	First release

## Disclaimer and exclusion of liability

DewertOkin is not responsible for damage resulting from:

- failure to observe these instructions,
  - changes made to this product which have not been approved by DewertOkin, or
  - the use of replacement parts which have not been approved or manufactured by DewertOkin.
- We reserve the right to make unannounced technical changes in the course of our continual product improvement process!

## Creation of a complete operating instruction manual for the entire end product

These instructions are only intended to be used by the end-product manufacturer. They should not be given to the operator of the end product. The factual information contained within may be used as a basis when creating the end-product manual.

The warning and danger notices are best suited for use in the end product's manual. However it is not sufficient to simply follow these notices. You should also carry out an internal risk assessment for your end product. This can then be used as the basis for the safety notices in your manual.

These installation instructions do not contain all information required to safely operate the end product. They only describe the installation and operation of the product as partially completed machinery.

The instructions are intended for the technicians responsible for manufacturing an end product and not for the operators of the end product.

## Usage in medical products

The PD24 POWER SUPPLY is not a medical product. If used in a medical end product, you (the end manufacturer) are obliged to ensure compliance with EC directives and to ensure that other pertinent medical product regulations are maintained.

# Table of Contents

<b>Foreword</b>	<b>3</b>
Document revision history	3
Disclaimer and exclusion of liability	3
Creation of a complete operating instruction manual for the entire end product	3
Usage in medical products	3
<b>Table of Contents</b>	<b>4</b>
<b>1. General Information</b>	<b>6</b>
1.1 Safety notices within the installation instruction and the operating instructions for the entire machine	6
1.2 Conventions used	6
<b>2. Safety notices</b>	<b>7</b>
2.1 Proper and intended usage	7
2.2 Selection and qualification of personnel	7
2.3 Ratings plate for the PD24 POWER SUPPLY	8
<b>3. Description</b>	<b>10</b>
3.1 Device components – PD24 POWER SUPPLY	10
<b>4. Technical specifications</b>	<b>12</b>
4.1 PD24 POWER SUPPLY	12
4.2 Dimensions of the PD24 POWER SUPPLY	13
<b>5. Installation</b>	<b>14</b>
5.1 Safety notices to observe during installation	14
5.2 Installation procedure	14
<b>6. Operating notes</b>	<b>17</b>
6.1 General information	17
<b>7. Troubleshooting</b>	<b>19</b>
<b>8. Maintenance and cleaning</b>	<b>20</b>
8.1 Maintenance	20
8.2 Cleaning	20
<b>9. Disposal</b>	<b>20</b>
9.1 Packaging material	20
9.2 Components in the PD24 POWER SUPPLY	20

**10. Declaration of Conformity**

**21**

# 1. General Information

These installation instructions must be observed in order to install this PD24 POWER SUPPLY successfully and safely in the end product. These instructions are not an operating manual for the end product. These instructions will help you to minimize danger. They will also help you to maximize the reliability and lifespan of the end product.



## CAUTION

The notices in these instructions must be followed! Following the guidelines during installation and connection procedures will help to minimize:

- the risk of accident and injury, and
- damage to the PD24 POWER SUPPLY or to the end product.

These installation instructions have been written with due care and attention. However, we cannot guarantee that the data, images and drawings are complete and correct nor do we accept any liability for the information contained therein, unless required by law.

### Availability of this document

As manufacturer of the end product, you are obligated to comply with Machinery Directive 2006/42/EC. This directive stipulates that the installation instructions must be kept on file for governmental inspection purposes.

## 1.1 Safety notices within the installation instruction and the operating instructions for the entire machine

The manufacturer of the complete machine (the end product) is only permitted to operate the PD24 POWER SUPPLY (by itself an incomplete machine)

- when the end product (for which the PD24 POWER SUPPLY is intended) is in compliance with all protective measures specified in the Machinery Directive 2006/42/EC, and
- when the manufacturer expressly declares the compliance of the end product.

The manufacturer of the end product must create a manual for the users of that product. The safety notices in the end-product manual must be written based on the end product's risk assessment.

## 1.2 Conventions used

Notices which do not relate to safety are indicated in these instructions with a symbol:

- ▶ Triangular notice symbol

### Safety notice explanations



## WARNING

WARNING indicates a hazardous situation which, if not avoided, could result in death or serious injury.



## CAUTION

CAUTION indicates a hazardous situation which, if not avoided, could result in minor or moderate injury.

## NOTICE

NOTICE is used to address practices which are not related to personal injury but may result in damage to the product or surroundings.

## 2. Safety notices

### 2.1 Proper and intended usage

The PD24 POWER SUPPLY is intended for use

- as a power supply unit for suitable DewertOkin drive systems,



#### CAUTION

##### Risk of accident

This PD24 POWER SUPPLY should only be used for the applications described above. Any other use is forbidden. Improper usage can lead to accidents or destruction of the unit. Such non-approved applications will lead immediately to the expiration of all guarantee and warranty claims on the part of the end-product manufacturer against the manufacturer.

#### 2.1.1 Improper usage

Be sure to follow the notices below concerning improper usage. You should include them in your product manual in order to inform the users of your end product.

The PD24 POWER SUPPLY may not be used:

- in any environment where combustible or explosive gases or vapours (e.g., anaesthesiology) may be present,
- in the proximity of open fires or other heat sources (such as furnaces, ovens or direct sunlight),
- as a power source for toys or games,
- in any application that will be cleaned with an automated washing system,
- in a moist environment, or
- outdoors.

The PD24 POWER SUPPLY can be used by children of 8 years and older, persons with reduced physical, sensory or mental capabilities, or persons with lack of experience or knowledge when they are supervised or instructed concerning the safe use of the device and when they understand the resulting risks. Do not allow children to play with this device. The cleaning and user maintenance must not be carried out by children without supervision.

- ▶ You should only use spare parts which have been manufactured or approved by DewertOkin. Only these parts will guarantee a sufficient level of safety.

### 2.2 Selection and qualification of personnel

This PD24 POWER SUPPLY should only be installed into the end product by someone who has completed training in electronic motor assembly or has equivalent qualifications.

You should only install this PD24 POWER SUPPLY when you are qualified to do so. Otherwise, a properly qualified person should be found for this task.

## 2.3 Ratings plate for the PD24 POWER SUPPLY

- ▶ The ratings plate shown is an example; the specifications for your PD24 POWER SUPPLY may differ from this illustration.

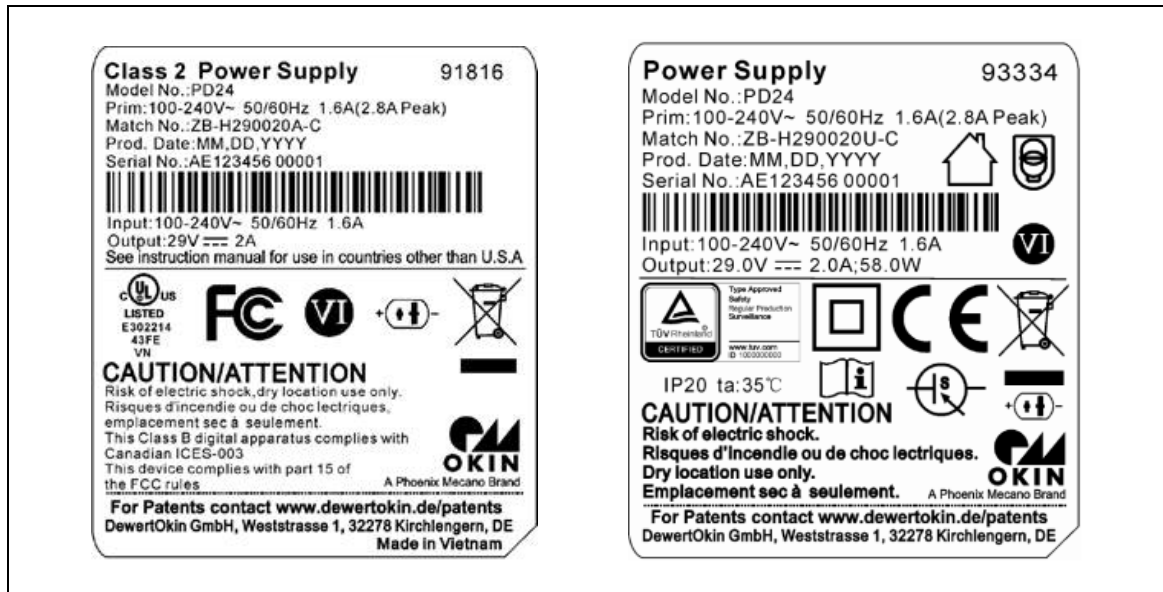





Figure 1 Example: Ratings plate for the PD24 POWER SUPPLY

PD24	Model name
Class 2 Power Unit	Power supply in compliance with UL1310
xxxxx	Model ID number
Model No.	Model number
Prod.date	Calendar week / year
Serial No.	Serial number
Input: AC100-240V 50/60 Hz	Input voltage and frequency
1.6 A	Current consumption
Output: DC 29 V --- 2.8 A	Output voltage and permitted max. output current during continuous operations
IP20	Protection degree
	Switched-mode power supply
	Use in dry rooms only!
	Protection class: II
	Short-circuit-proof safety transformer





Compliance

EFFICIENCY LEVEL: **VI**

Efficiency class



Follow all special disposal instructions!



LSP socket

### 3. Description

The PD24 POWER SUPPLY is an external power supply unit intended to supply power to drives and controllers from DewertOkin. The PD24 POWER SUPPLY is connected to the mains power using a mains power cord. The PD24 POWER SUPPLY has a non-referenced (unearthed) circuit which is separated from the supply voltage by means of doubled reinforced insulation.

#### 3.1 Device components – PD24 POWER SUPPLY



Figure 2 Versions of the POWER SUPPLY PD24

### 3.1.1 Power supply connection for the PD24 POWER SUPPLY

**! WARNING**

**Electric shock**

Please follow these operating instructions carefully. You could be injured by fire or electrical shock if you do not follow these assembly instructions.

**! CAUTION**

Only use the proper power cord that is permitted in your country. Be sure to use the correct plug adapter, as described in **Fehler! Verweisquelle konnte nicht gefunden werden.**

### 3.1.2 Electrical output (optional)

An LSP plug is used to connect the drive system.

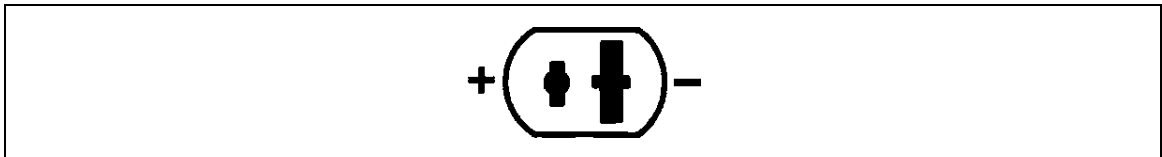

Figure 3 Electrical output: Connection for the LSP plug

## 4. Technical specifications

### 4.1 PD24 POWER SUPPLY

Mains power supply connection	100 – 240 V AC 50/60 Hz
Output voltage (under no load)	Max. 29 V DC
Output voltage / output current	Output: 29 V $\overline{\text{---}}$ 2 A for continuous operations
Output voltage / output current	24 V $\overline{\text{---}}$ 4.0 A for intermittent operations: 2 min./18 min. <sup>1)</sup>
Primary fuse	4.00 A
Standby (no load)	≤ 0.21 W (without load at the output)
Degree of efficiency	≥ 0.88
Efficiency Level	VI
Protection class	II
Variants	LSP socket
Protection degree	IP20
<b>Dimensions and weight</b>	
Length x width x height (with adapter plate)	Approx. 100 mm x 49 mm x 38 mm
Weight (with batteries)	Approx. 430 g
<b>Ambient conditions for operation, storage and transport</b>	
Transport / storage temperature	From -20 °C to +50 °C From -4 °F to +122 °F
Operating temperature	From +10 °C to +25 °C From +50 °F to +77 °F
Relative humidity	From 30% to 75%
Air pressure	From 800 hPa to 1060 hPa
Height	< 2000 m

<sup>1)</sup> Mode of operation: intermittent duty 2 min./18 min. This means that after the unit is operated with its rated load for up to two minutes it must then be paused for 18 minutes. The system can malfunction if this pause is not observed!

## 4.2 Dimensions of the PD24 POWER SUPPLY

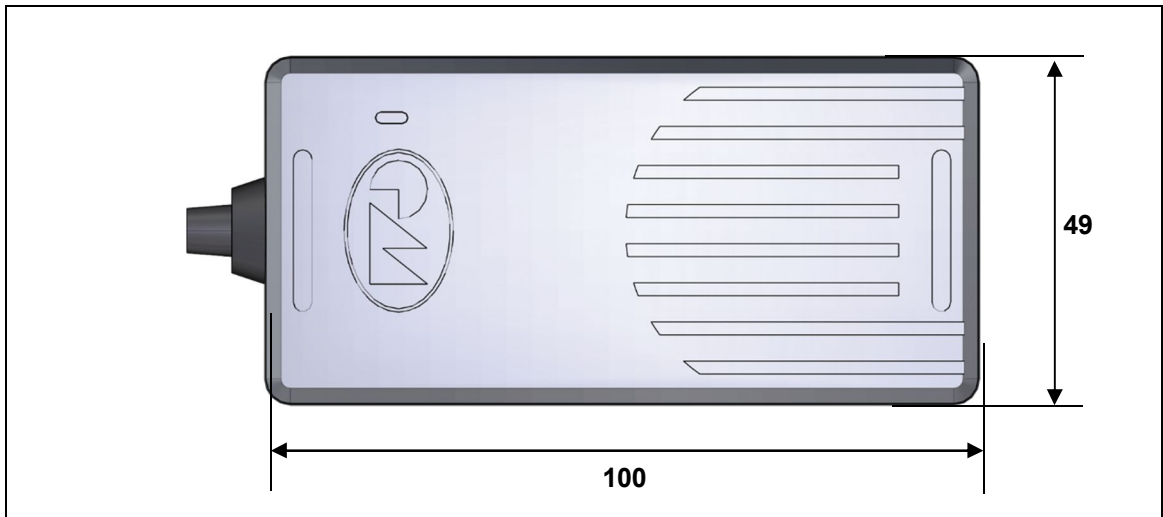

Figure 4 Dimensions of the PD24 POWER SUPPLY, top view (in mm), deviations are possible

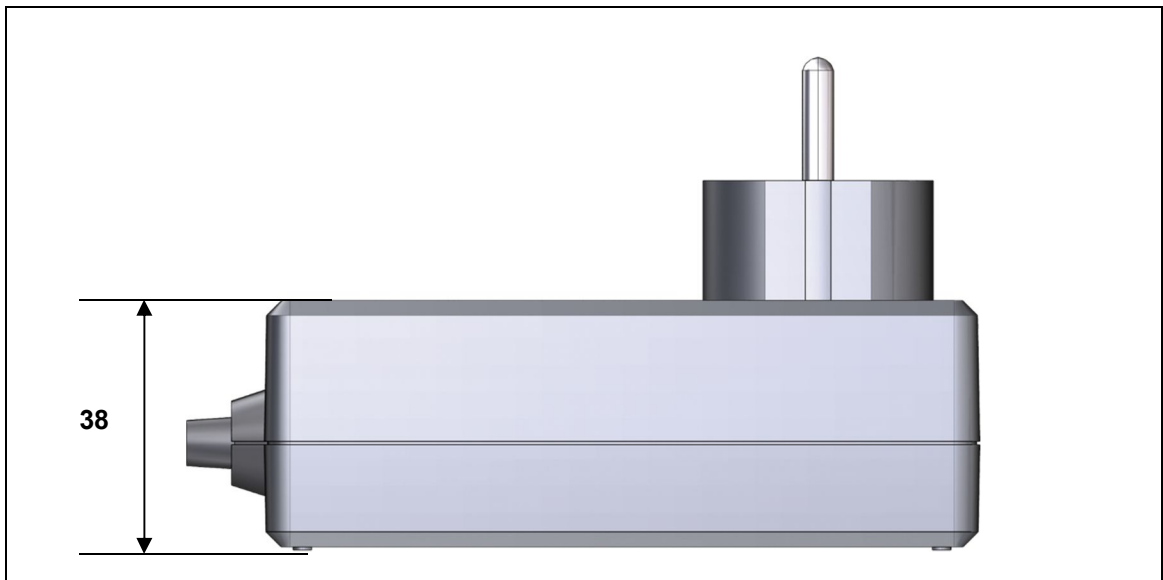

Figure 5 Dimensions of the PD24 POWER SUPPLY, side view (in mm), deviations are possible

## 5. Installation

### 5.1 Safety notices to observe during installation

Basic safety rules must be followed in order to ensure that the end product can be continually operated in a safe manner. These rules must be observed while using the end product and while installing the PD24 POWER SUPPLY in the end product.

#### Avoiding electrical faults

The power supply cord (when available) is designed to be connected to an outlet near the floor. Be sure to consider the length of the power cord when designing the dimensions for your application in order to minimize the associated risks.

### 5.2 Installation procedure

Before installing the PD24 POWER SUPPLY, make sure that you are observing all of the safety notices found in the "Safety notices to observe during installation" section.

#### 5.2.1 Installing the PD24 POWER SUPPLY

The PD24 POWER SUPPLY is used as an accompanying device without any mounting or bolting down required.

As an accompanying device, you should be sure that any dangers presented by the cables are described in your end-product operating manual (refer to section "Electrical connection").



#### CAUTION

The mains power plug should be unplugged during the installation.

## 5.2.2 Electrical connection

### CAUTION

#### Electric shock

Electrical components should be connected or disconnected only when the power supply cord is unplugged.

- ▶ There is a delay after the supply voltage is applied before the device actually turns on. Wait at least 7 seconds before initial commissioning.

#### Routing the electrical cables

When routing the cables, be sure that:

- the cables cannot get jammed,
- no mechanical load (such as pulling, pushing or bending) will be put on the cables, and
- the cables cannot be damaged in any way.

Fasten all cables (especially the connecting cables) to the end product using sufficient kink prevention methods. Be sure that the design of the end product prevents the connecting cables from coming into contact with the floor during transport.

### CAUTION

Insert the power plug into the socket in an upright vertical position (as shown in **Fehler! Verweisquelle konnte nicht gefunden werden.6**).

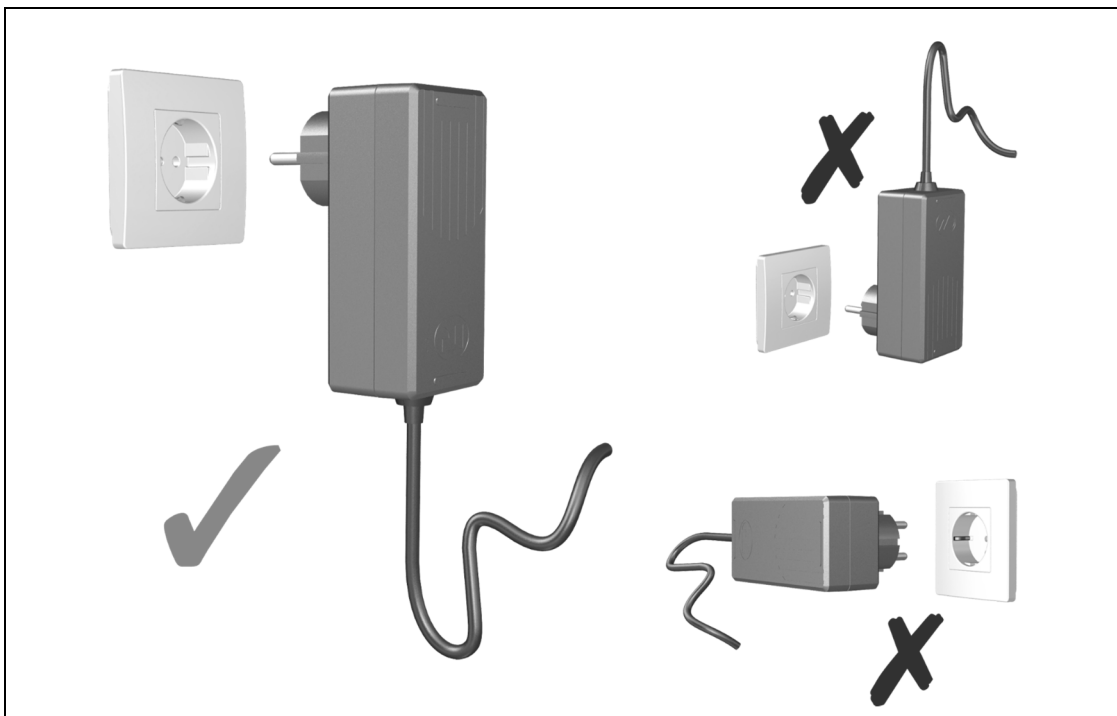



Figure 6 Position of the power plug when plugging into the power outlet

### 5.2.3 Connecting the drive system to the PD14/PD15 Power Supply

An LSP socket is used to connect to the control unit (as shown in **Fehler! Verweisquelle konnte nicht gefunden werden.**).

- 1 Disconnect the power plug from the power outlet.

	 <b>CAUTION</b>
	You should only connect and disconnect the cables when they are completely disconnected from any live current!



- 2 Insert the drive system's LSP plug into the LSP socket on the connection cable for the PD24 Power Supply.

After plugging the power plug into the power outlet:

	<b>NOTICE</b>
	There is a delay after the supply voltage is applied before the device actually turns on. Wait at least seven seconds before start up.

### 5.2.4 Removing the PD14/PD15 Power Supply

- 1 Disconnect the power plug from the power outlet.

	 <b>CAUTION</b>
	You should only connect and disconnect the cables when they are completely disconnected from any live current!

- 2 Disconnect the control unit's cable from the PD24 Power Supply.



## 6. Operating notes

The factual information contained within may be used when you are creating the end-product manual. The installation instructions do not contain all information required for the safe operation of the end product. They only describe the assembly and operation of the PD24 POWER SUPPLY as a partially assembled piece of machinery.

- ▶ When creating the operating instructions, remember that the installation instructions are intended for qualified specialists and are not for typical users of the end product.

### 6.1 General information

- ▶ Only drives and drive control units from DewertOkin should be connected to the PD24 POWER SUPPLY, since they have already been verified to work together.

#### Delayed start-up

After plugging the power plug into the power outlet,

- ▶ There is a delay after the supply voltage is applied before the device actually turns on. Wait at least 2 seconds before initial commissioning.

#### The use of a power cord and optional power adapter

##### WARNING

##### Risk of accident

Please follow these operating instructions carefully. You could be injured by fire or electrical shock if you do not follow these assembly instructions.

##### CAUTION

Only use the proper power cord that is permitted in your country. Be sure to use the correct plug adapter, as described in **Fehler! Verweisquelle konnte nicht gefunden werden..**

#### Reducing the risk of overheating with the thermal monitor

##### CAUTION

##### Risk of accident

The PD24 POWER SUPPLY is equipped with a thermal fuse that triggers when the unit overheats. If the temperature control has triggered, remove the PD24 POWER SUPPLY from the power supply, allow it to rest for 20 to 30 minutes and try again. If the unit still does not function, please contact your supplier or dealer.

## Avoiding electrical risks



### CAUTION

#### Electric shock

Make sure that all live (current-carrying) parts of the drive system and power supply cannot be touched. In particular, be sure that unused power and control unit connections are covered adequately.

## Emergency shutoff of a connected drive or drive control unit

Unplug the PD24 POWER SUPPLY from the power outlet if there is an emergency. The mains power plug must be accessible at all times during operation so that it can be unplugged when the drive or drive controller need to be powered down.

## Avoiding cable damage

Be sure that your operating instructions inform the user about the possible cable risks.



### CAUTION

#### Risk of accident

The cables (particularly the mains cable and connecting cable) should not be run over. In order to prevent injuries or damage to the PD24 POWER SUPPLY, no mechanical strain should be placed on the cables.

## 7. Troubleshooting

This chapter describes troubleshooting methods for fixing problems. If you experience an error that is not listed in this table, please contact your supplier.

- Only qualified specialists who have received electrician training should carry out troubleshooting and repairs.

Problem	Possible cause	Solution
The drive or drive control unit is not functioning.	There is no mains supply voltage.	Connect the mains power.
	The drive or drive control unit is defective.	Please contact your supplier or sales agent.
The drive is suddenly not capable of movement.	The overheating protection or system protection has been triggered.	Remove the overload (change or remove the load). Allow the system to rest for 20 to 30 minutes with the mains power unplugged. If this does not resolve the problem, contact your supplier or distributor.
	The unit's fuse may have been triggered.	Please contact your supplier or sales agent.
	There is no mains supply voltage.	Connect the mains power.
	A lead-in connection has been interrupted (mains power, auxiliary drive or handset).	Check the cables and reinsert them, if required.
Battery-operated reset does not function.	Battery is empty.	Check the batteries and replace if necessary.
	Battery is not connected.	Connect the batteries.

## 8. Maintenance and cleaning

### 8.1 Maintenance

- ▶ The PD24 POWER SUPPLY requires no special maintenance.

### 8.2 Cleaning

- ▶ Clean the PD24 POWER SUPPLY as needed using a dry anti-static cloth.

#### **NOTICE**

- Be sure to unplug the PD24 POWER SUPPLY's power cord before you begin cleaning.
- Do not use a cleanser that contains benzene, alcohol or similar solvents.
- Be sure that you do not damage the connecting cables during the cleaning.

## 9. Disposal

### 9.1 Packaging material

The packaging material should be sorted into recyclable components and then disposed of in accordance with the appropriate national environmental regulations (in Germany according to the recycling law KrWG from 01.06.2012; internationally according to the EU Directive 2008/98/EC (Waste Framework Directive WFD as of 12.12.2008)).

### 9.2 Components in the PD24 POWER SUPPLY

The PD24 POWER SUPPLY consists of electronic components, cables and metal and plastic parts. You should observe all corresponding national and regional environmental regulations when disposing of the PD24 POWER SUPPLY.

The disposal of the product is regulated in Germany by Elektro-G, internationally by the EU Directive 2012/19/EC (WEEE), or by any applicable national laws and regulations.



This PD24 POWER SUPPLY should not be disposed of with normal household waste!

## 10. Declaration of Conformity

<b>EG-Konformitätserklärung</b>	<b><i>EU Declaration of Conformity</i></b>
Nach Anhang IV der EMV-Richtlinie 2014/30/EU	<i>In compliance with Appendix IV of the EMC-Directive 2014/30/EU</i>
Nach Anhang IV der EU-Niederspannungsrichtlinie 2014/35/EU	<i>In compliance with Appendix IV of the LVD-Directive 2014/35/EU</i>
Nach Anhang VI der RoHS-Richtlinie 2011/65/EU (inkl. Delegierte Richtlinie (EU) 2015/863)	<i>In compliance with Appendix VI of the EU RoHS Directive 2011/65/EU (incl. Commission delegated Directive (EU) 2015/863)</i>
Der Hersteller	<i>The manufacturer:</i>
	DewertOkin GmbH Weststraße 1 32278 Kirchlengern Deutschland - Germany
erklärt hiermit, dass das Produkt	<i>declares that the following product</i>
<b>POWER SUPPLY PD24 mit DewertOkin Komponenten</b>	
die Anforderungen folgender EG-Richtlinien erfüllt:	<i>meets the requirements of the following EU directives:</i>
<b>Richtlinie über elektromagnetische Verträglichkeit 2014/30/EU</b>	<b><i>Electromagnetic Compatibility Directive 2014/30/EU</i></b>
<b>Niederspannungsrichtlinie 2014/35/EU</b>	<b><i>Low Voltage Directive 2014/35/EU</i></b>
<b>DELEGIERTE RICHTLINIE (EU) 2015/863 DER KOMMISSION vom 31. März 2015 zur Änderung von Anhang II der Richtlinie 2011/65/EU des Europäischen Parlaments und des Rates hinsichtlich der Liste der Stoffe, die Beschränkungen unterliegen.</b>	<b><i>COMMISSION DELEGATED DIRECTIVE (EU) 2015/863 of 31 March 2015 amending Annex II to Directive 2011/65/EU of the European Parliament and of the Council as regards the list of restricted substances.</i></b>
Angewendete Normen	<i>Applied Standards:</i>
	<ul style="list-style-type: none"><li>• EN 55014-1:2006/A1:2009/A2:2011</li><li>• EN 55014-2:1997/A1:2001/A2:2008</li><li>• EN 61000-3-2:2014</li><li>• EN 61000-3-3:2013</li><li>• EN 61558-1:2005+A1:2009</li><li>• EN 61558-2-16:2009+A1:2013</li><li>• EN 62233:2008</li></ul>
Konstruktive Änderungen, die Auswirkungen auf die in der Montageanleitung angegebenen technischen Daten und den bestimmungsgemäßen Gebrauch haben, das Produkt also wesentlich verändern, machen diese Konformitätserklärung ungültig!	<i>This declaration of conformity is no longer valid if constructional changes are made which significantly change the drive system (i.e., which influence the technical specifications found in the instructions or the intended use)!</i>
Kirchlengern, Germany 31 August 2019	 Dr.-Ing. Josef G. Groß Geschäftsführer / Managing Director

DewertOkin GmbH  
Weststrasse 1  
Kirchlengern 32278, Germany  
Tel: +49 (0)5223/979-0  
Fax.: +49 (0)5223/75182  
<http://www.dewertokin.de>  
[Info@dewertokin.de](mailto:Info@dewertokin.de)