



# **ACCUCONTROL 3.0**

# **ACCUCONTROL 3.0 XL**

## **Installation Instructions**

**(Translation of the original installation instructions)**



# Foreword

## Document revision history

Version	Date
V 1.0	01/2019

## Disclaimer and exclusion of liability

DewertOkin is not responsible for damage resulting from:

- failure to observe these instructions,
- changes made to this product which have not been approved by DewertOkin, or
- the use of replacement parts which have not been approved or manufactured by DewertOkin.

## Manufacturer's address

DewertOkin GmbH  
Weststrasse 1  
32278 Kirchlengern, Germany  
Germany  
Tel: +49 (0)5223/979-0  
Fax.: +49 (0)5223/75182  
<http://www.dewertokin.de>  
[Info@dewertokin.de](mailto:Info@dewertokin.de)

## Creation of a complete operating instruction manual for the entire end product

These instructions are only intended to be used by the end-product manufacturer. They should not be given to the operator of the end product. The factual information contained within may be used as a basis when creating the end-product manual.

The warning and danger notices are best suited for use in the end product's manual. However it is not sufficient to simply follow these notices. You should also carry out an internal risk assessment for your end product. This can then be used as the basis for the safety notices in your manual.

## Usage in medical products

The *ACCUCONTROL* control unit is not a medical product. If used in a medical end product, you (the end manufacturer) are obliged to ensure compliance with EC directives and to ensure that other pertinent medical product regulations are maintained.

## Notice for customers in EU nations

### German Inspection Authority (TÜV SÜD Product Service) testing label

The construction of the *ACCUCONTROL* has been inspected by the German TÜV SÜD Product Service Inspection Authority. TÜV SÜD Product Service also monitors the production of the *ACCUCONTROL*. The official German TÜV SÜD Product Service certifies this construction inspection and production monitoring.



Figure 1 TÜV SÜD Product Service Safety Mark

# Table of Contents

<b>Foreword</b>	<b>3</b>
Document revision history	3
Disclaimer and exclusion of liability	3
Manufacturer's address	3
Creation of a complete operating instruction manual for the entire end product	3
Usage in medical products	3
Notice for customers in EU nations	4
<b>Table of Contents</b>	<b>5</b>
<b>1. General Information</b>	<b>7</b>
1.1 Configurations	7
1.2 About these installation instructions	7
1.3 Conventions used	7
<b>2. Safety notices</b>	<b>8</b>
2.1 Proper and intended usage	8
2.2 Selection and qualification of personnel	9
2.3 Notice on safety during operations	9
2.4 Product labelling	10
<b>3. Possible combinations</b>	<b>12</b>
3.1 ACCUCONTROL 3.0 / ACCUCONTROL 3.0 XL	12
3.2 Overview of components (examples)	13
3.3 IPROXX handset	14
<b>4. Description</b>	<b>15</b>
4.1 Components	15
4.2 ACCUCONTROL 3.0 with pluggable mains connecting cable	15
4.3 ACCUCONTROL 3.0 XL with connecting port for PLUG-IN CHARGER	16
<b>5. Technical specifications</b>	<b>18</b>
<b>6. Installation</b>	<b>21</b>
6.1 Safety notices to observe during installation	21
6.2 Installation procedure	22
<b>7. Operating notes</b>	<b>27</b>
7.1 General information	27
7.2 Programming the over-current shutdown mechanism when commissioning the system	29
89535 1.0	5

<b>7.3</b>	<b>ACCUCONTROL</b>	<b>30</b>
<b>7.4</b>	<b>Charging the ACCUCONTROL</b>	<b>31</b>
<b>7.5</b>	<b>Keypad for the ACCUCONTROL</b>	<b>34</b>
<b>7.6</b>	<b>Buttons and indicators on the IPROXX 2 handset (an example)</b>	<b>37</b>
<b>7.7</b>	<b>Emergency-stop switch</b>	<b>38</b>
<b>8.</b>	<b>Troubleshooting</b>	<b>39</b>
<b>9.</b>	<b>Maintenance</b>	<b>40</b>
<b>9.1</b>	<b>Maintenance</b>	<b>40</b>
<b>9.2</b>	<b>Cleaning and care</b>	<b>41</b>
<b>9.3</b>	<b>Maintenance and care</b>	<b>41</b>
<b>10.</b>	<b>Disposal</b>	<b>43</b>
<b>10.1</b>	<b>Packaging material</b>	<b>43</b>
<b>10.2</b>	<b>Components of the ACCUCONTROL</b>	<b>43</b>
<b>10.3</b>	<b>Batteries</b>	<b>43</b>
	<b>EU Declaration of Conformity</b>	<b>44</b>
	<b>Additional information</b>	<b>45</b>

# 1. General Information



## 1.1 Configurations

Both ACCUCONTROL models (3.0 and 3.0 XL) are referred to here by the name *ACCUCONTROL*, unless reference is being made to a model-specific feature. The "Possible combinations" chapter includes information about the different device combinations available.

## 1.2 About these installation instructions

In order to install this *ACCUCONTROL* successfully and safely in the end product, these installation instructions must be observed. These instructions are not an operating manual for the end product.

These instructions will help you to minimize danger, repair costs and down times. They will also help you to maximize the reliability and lifespan of the end product.

	 <b>CAUTION</b>
	The notices in these instructions must be followed! Following the guidelines during installation and connection procedures will help to minimize: <ul style="list-style-type: none"> <li>• the risk of accident and injury, and</li> <li>• damage to the ACCUCONTROL or the end product.</li> </ul>

These installation instructions have been written with due care and attention. However, we cannot guarantee that the data, images and drawings are complete and correct nor do we accept any liability for the information contained therein, unless required by law.



- ▶ We reserve the right to make unannounced technical changes in the course of our continual product improvement process!



## 1.3 Conventions used

Hinweise, die nicht die Sicherheit betreffen, werden im Text durch ein Symbol kenntlich gemacht:

- ▶ Symbol für Hinweise

### Erläuterungen der Warnhinweise

	 <b>WARNING</b>
	WARNING indicates a hazardous situation which, if not avoided, could result in death or serious injury.

	 <b>CAUTION</b>
	CAUTION indicates a hazardous situation which, if not avoided, could result in minor or moderate injury.



	<b>NOTICE</b>
	NOTICE is used to address practices which are not related to personal injury but may result in damage to the product or surroundings.

## 2. Safety notices

### 2.1 Proper and intended usage



The *ACCUCONTROL* control unit is intended to be used as a control unit and battery-operated power supply for the appropriate DewertOkin drive systems in use



- for care purposes,
- or in hospitals.

 <b>CAUTION</b>
<div style="display: flex; align-items: center;">  <div> <p>The <i>ACCUCONTROL</i> should only be used for the applications described above. Any other use is forbidden. Improper usage can lead to accidents or destruction of the unit. Such non-approved applications will lead immediately to the expiration of all guarantee and warranty claims on the part of the end-product manufacturer against the manufacturer.</p> </div> </div>

#### 2.1.1 Improper usage

Be sure to follow the notices below concerning improper usage. You should include them in your product manual in order to inform the users of your end product.

 <b>WARNING</b>
<div style="display: flex; align-items: center;">  <div> <p>The <i>ACCUCONTROL</i> should not be used:</p> <ul style="list-style-type: none"> <li>• in any environment where combustible or explosive gases or vapours (e.g., anaesthesiology) may be present,</li> <li>• in the proximity of open fires or other heat sources (such as furnaces, ovens or direct sunlight),</li> <li>• as a power source for toys or games,</li> <li>• in any application that will be cleaned with an automated washing system,</li> <li>• in a moist environment, or</li> <li>• outdoors.</li> </ul> </div> </div>

 <b>CAUTION</b>
<div style="display: flex; align-items: center;">  <div> <p>The <i>ACCUCONTROL</i> may not be operated:</p> <ul style="list-style-type: none"> <li>• by small children,</li> <li>• by frail or infirm persons without supervision, or</li> <li>• in the proximity of small children.</li> </ul> </div> </div>

The *ACCUCONTROL* can be used by children of 8 years and older, persons with reduced physical, sensory or mental capabilities, or persons with lack of experience or knowledge when they are supervised or instructed concerning the safe use of the device and when they understand the resulting risks. Do not allow children to play with this device. The cleaning and user maintenance must not be carried out by children without supervision.

- ▶ You should only use spare parts which have been manufactured or approved by DewertOkin. Only these parts will guarantee a sufficient level of safety.



**Using the drive systems in medical applications**

This DewertOkin product complies with the safety requirements found in IEC 60601-1.

We strongly recommend that the end product (including all its components) which you are manufacturing for a medical application should also comply with the safety requirements found in IEC 60601-1.

You should make sure that the mechanical movement of the motor in your end product poses no risk of injury. Conduct a risk analysis for the end product for this purpose. You should also include safety notices in the instructions for the end product and technical safeguards in your product to eliminate any risk.

**2.2 Selection and qualification of personnel**

This *ACCUCONTROL* should only be installed into the end product by someone who has completed training in electronic motor assembly or has equivalent qualifications.

You should only install this *ACCUCONTROL* when you are qualified to do so. Otherwise, a properly qualified person should be found for this task.

**2.3 Notice on safety during operations**

Basic safety rules must be followed in order to ensure that the end product can be continually operated in a safe manner. These rules must be observed while using the end product and while installing the *ACCUCONTROL* in the end product.



These rules and safety measures can be categorized as follows:

- Construction measures before the installation (refer to the "Ensuring operational reliability during installation" section in Chapter "Installation").
- Safety fundamentals during the installation of the *ACCUCONTROL* and during cable and wire routing (refer to the "Electrical connection" section in the Chapter "Installation")
- Basic safety rules during operation (refer to the "Operating notes" Chapter).
- The creation of a manual for the end product which contains these and other safety rules.

**2.3.1 Creating a user's manual**



The manufacturer of the end product must create a manual for the users of that product. The safety notices in the end-product manual must be written based on the end product's risk assessment.

**2.3.2 Electrical safety**

	 <b>CAUTION</b>
	Be careful; there is a risk of electrical shock! Be sure to unplug the mains plug to the charging station or the PLUG-IN CHARGER before you begin assembly! Make sure that the mains plug or PLUG-IN CHARGER is accessible at all times.

- ▶ The *ACCUCONTROL* must not be opened! Defective devices can be returned to your customer service representative for repair.

2.3.3 Shutting down in an emergency

 <b>CAUTION</b>
 <p>In an emergency, the control unit can be shut down by pressing the emergency-stop switch. The emergency-stop switch must always be accessible during operations so that it can be quickly pressed in an emergency.</p>

2.4 Product labelling

2.4.1 Ratings plate (type label)

- ▶ The ratings plate shown is an example; the specifications for your ACCUCONTROL may differ from this illustration.

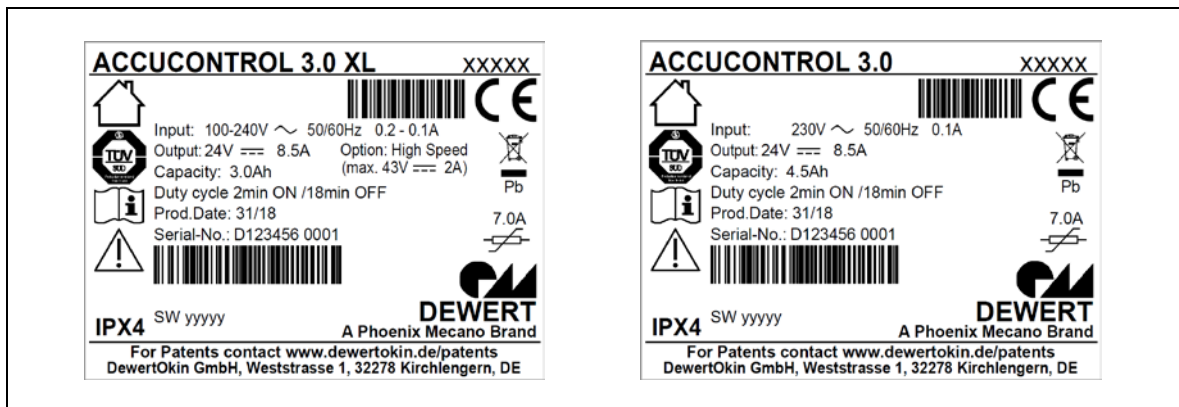





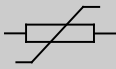

Figure 2 Ratings plate for the ACCUCONTROL 3.0 XL and ACCUCONTROL 3.0 (examples)

ACCUCONTROL 3.0 XL	Type designations
ACCUCONTROL 3.0	
xxxxx	Article number
Input: 100 – 240 V, 230 V ~ 50/60 Hz	Input voltage and frequency
0.2 – 0.1A, 0.1 A	Current consumption
Output: 24 V = 8.5 A	Output voltage, max. current
Optional: High Speed (43 V = 2 A)	Output voltage, max. current (for the High Speed variant)
Capacity: 4.5 Ah, 3.0 Ah	Capacity
Prod.date	Calendar week / year
Serial No.	Serial number
IPX4	Protection degree
SW: yyyy	Software version

	Use in dry rooms only!
	Follow all special disposal instructions!
	Conformity mark
	Follow the special assembly instructions!
	Attention:
	PolySwitch

### 3. Possible combinations

The *ACCUCONTROL* can be combined with various components. The following basic combinations are possible:

- A stroke drive and/or slave drive connected to the *ACCUCONTROL*, and a handset, Systems can be customized by combining the drive, *ACCUCONTROL* and handset.

DewertOkin has separate system instruction manuals containing the additional information and instructions needed for these systems. You can also find more information at [www.dewertokin.de](http://www.dewertokin.de).

- 1) Stroke drive: MEGAMAT P, GIGAMAT GMZ, MEGAMAT MFZ
- 2) Slave drive: MEGAMAT MCZ, MEGAMAT XSZ
- 3) Handset: IPROXX, IPROXX 2
- 4) Charger: PLUG-IN CHARGER for the variant with the short connecting cable

#### 3.1 ACCUCONTROL 3.0 / ACCUCONTROL 3.0 XL

##### 3.1.1 Configuration options

	ACCUCONTROL 3.0	ACCUCONTROL 3.0 XL
Internal charging circuit	X	X
External PLUG-IN CHARGER		X
Lift drive	X	X
Spreader drive		X
Battery capacity 3.0 Ah	X	X
Battery capacity 4.5 Ah		X
Degree of protection IPX4	X	X
Degree of protection IPX6		X
Battery indicator: 3 levels	X	X
Service display: 3 levels	X	X
Service data can be exported		X
Soft start	X	X
Soft stop	X	X
High speed function		X
Programming ÜSA		X

- Ask your customer service representative for other possible options.

### 3.2 Overview of components (examples)

#### 3.2.1 ACCUCONTROL (with 1 or 2 motors)

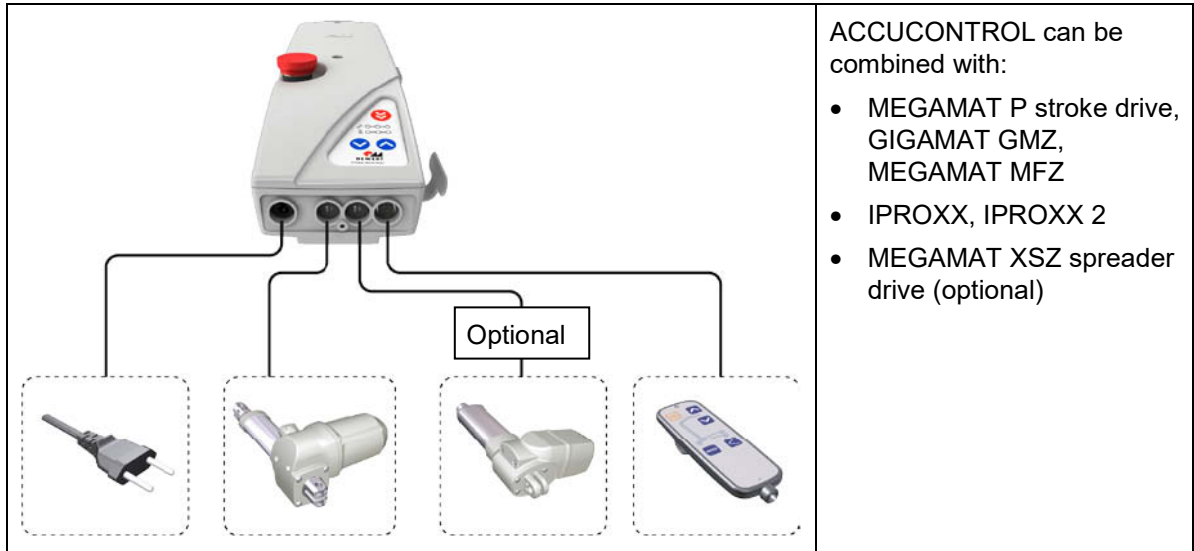

#### 3.2.2 ACCUCONTROL (with 1 or 2 motors)

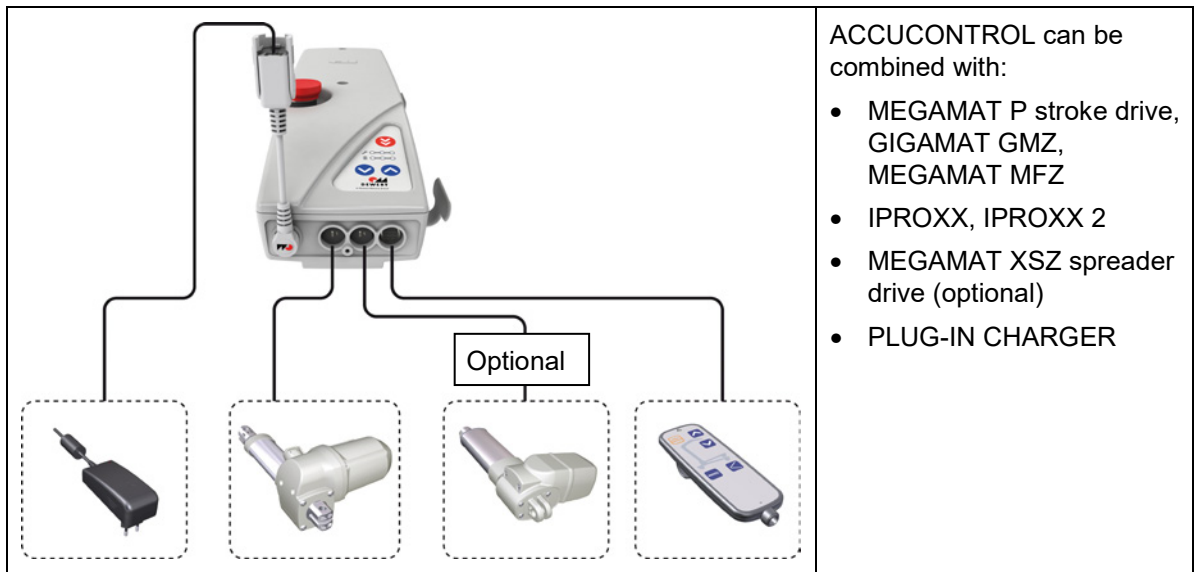

### 3.3 IPROXX handset

The following illustrations show the IPROXX handsets that can be used in the different models.

#### 3.3.1 Handset versions

##### IPROXX 2

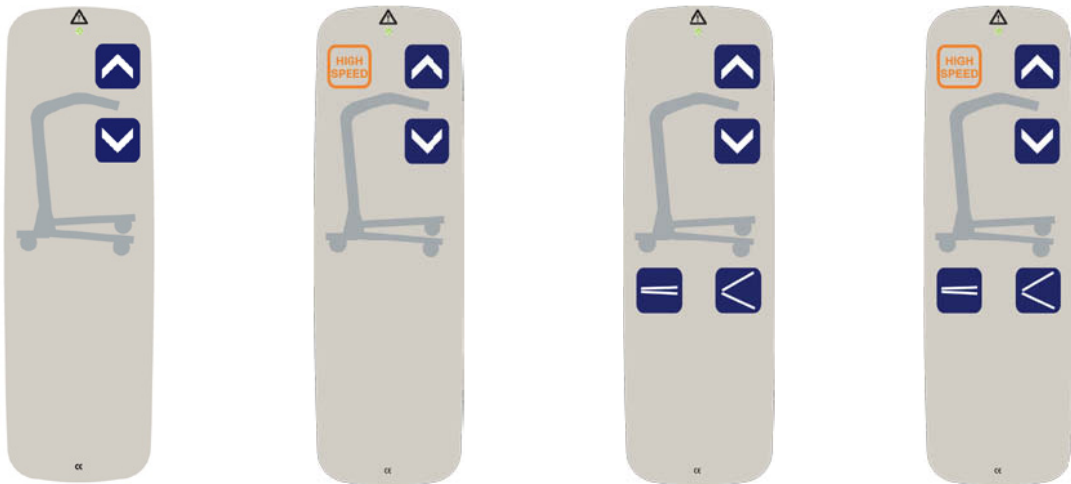

##### IPROXX

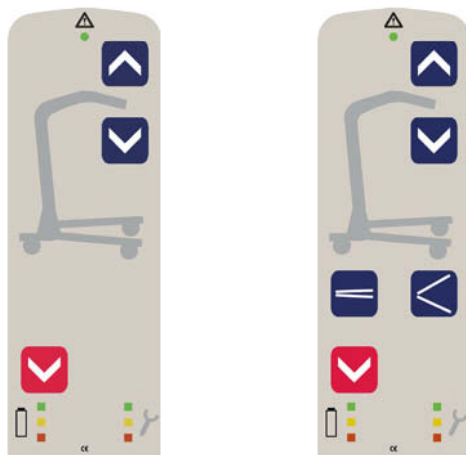

## 4. Description

The *ACCUCONTROL* is used for supplying power to and controlling one or more DewertOkin drives.

- ▶ We reserve the right to make unannounced technical changes in the course of our continual product improvement process!

### 4.1 Components

The *ACCUCONTROL* with connecting ports for drives, IPROXX/IPROXX 2 handset and PLUG-IN CHARGER. The MEGAMAT P, MEGAMAT MCZ, MEGAMAT MFZ, MEGAMAT XSZ and GIGAMAT GMZ drives can be connected to the *ACCUCONTROL*.

### 4.2 ACCUCONTROL 3.0 with pluggable mains connecting cable

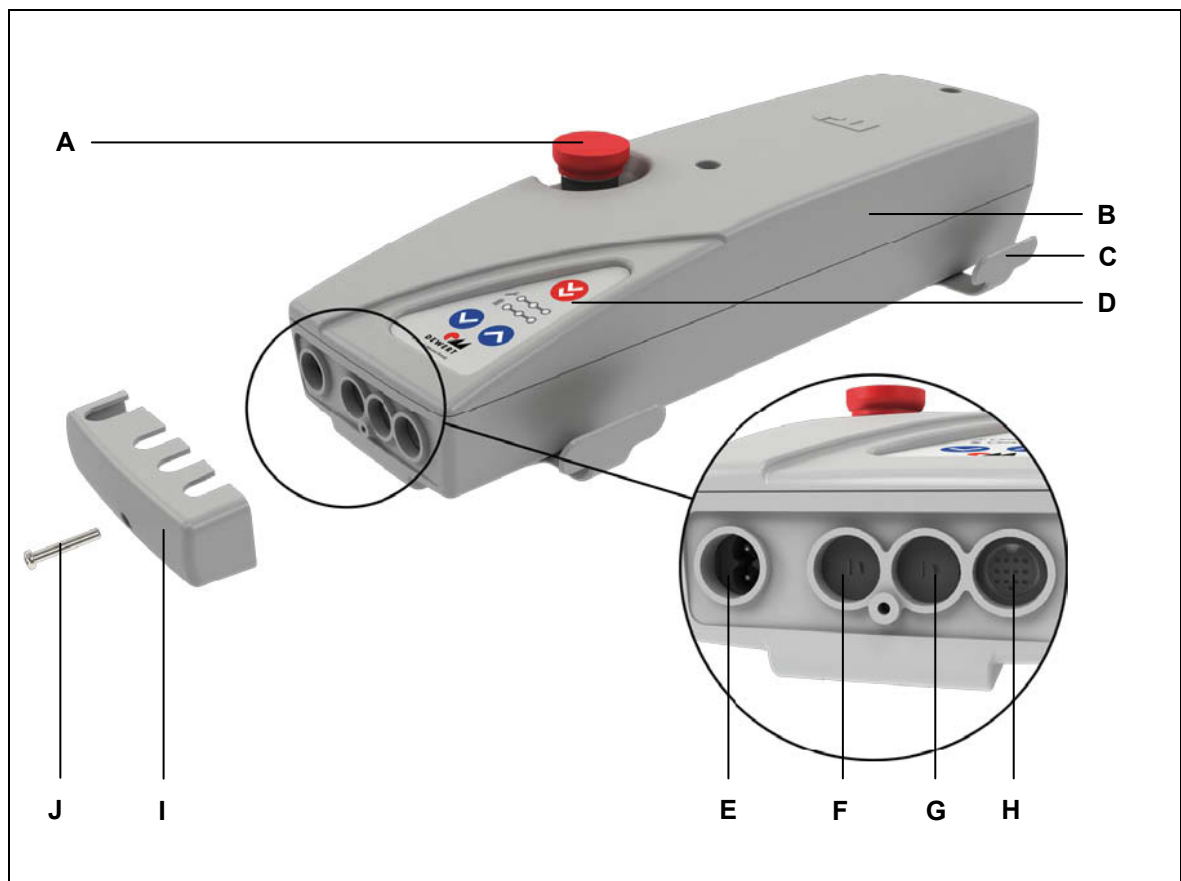

Figure 3 Components of the *ACCUCONTROL 3.0* with pluggable mains connecting cable

- |   |   |
|---|---|
| <b>A</b> Emergency-stop switch  | <b>B</b> ACCUCONTROL 3.0                  |
| <b>C</b> Cable holder (not mounted when delivered) (can be attached on either side) | <b>D</b> Control Keypad                   |
| <b>E</b> Power socket   | <b>F</b> Connecting socket (stroke drive) |
| <b>G</b> Connecting socket (optional spreader drive)                                | <b>H</b> Connecting socket for handset    |
| <b>I</b> Shield cover (pull-out protection, not mounted when delivered)             | <b>J</b> Mounting screw                   |

### 4.3 ACCUCONTROL 3.0 XL with connecting port for PLUG-IN CHARGER

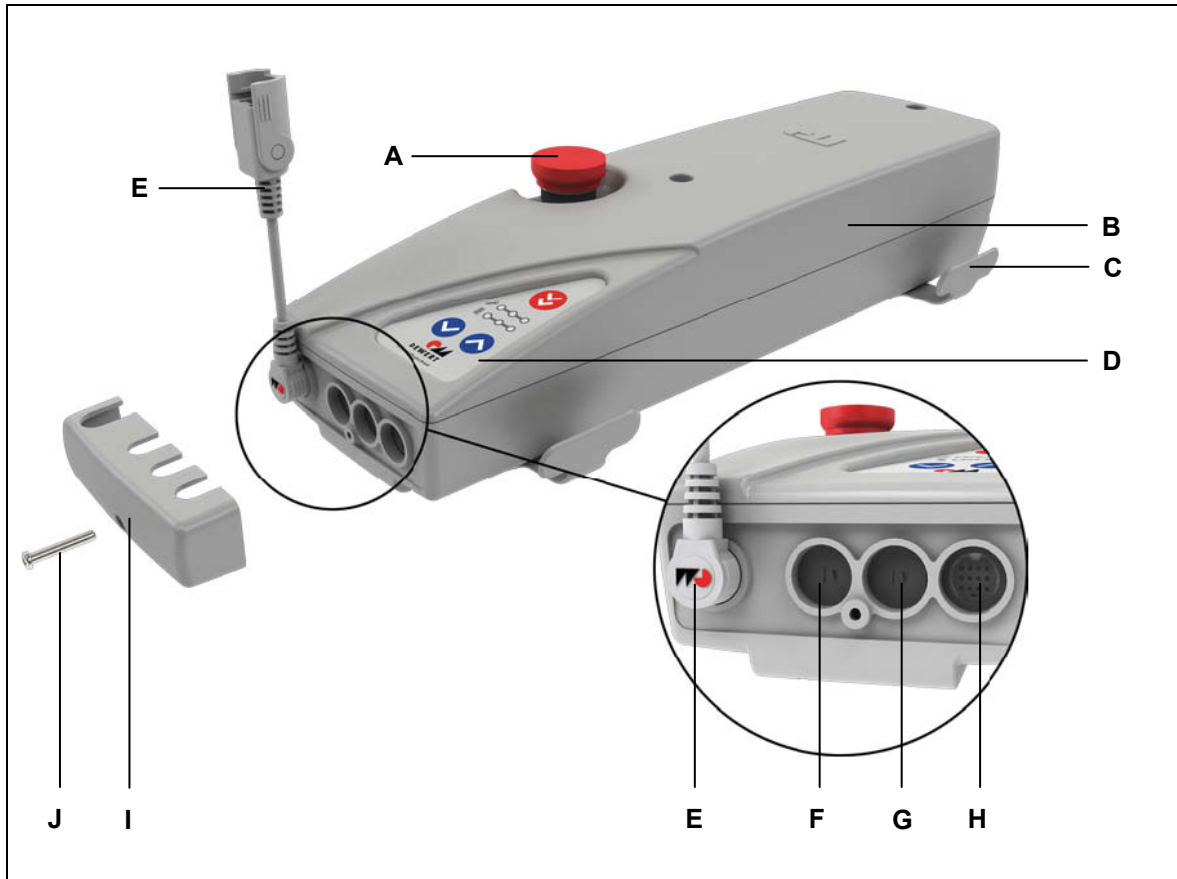



Figure 4 Components of the ACCUCONTROL 3.0 XL with the short connecting cable



- |  |   |
|--|---|
| <b>A</b> Emergency-stop switch   | <b>B</b> ACCUCONTROL 3.0 XL               |
| <b>C</b> Cable holder (not mounted when delivered) ( can be attached on either side) | <b>D</b> Control keypad                   |
| <b>E</b> Short connecting cable with locking coupling (for the PLUG-IN CHARGER)      | <b>F</b> Connecting socket (stroke drive) |
| <b>G</b> Connecting socket (optional spreader drive)                                 | <b>H</b> Connecting socket for handset    |
| <b>I</b> Shield cover (pull-out protection, not mounted when delivered)              | <b>J</b> Mounting screw                   |



4.3.1 Mains power supply connection

	 <b>WARNING</b>
<p>Please follow these operating instructions carefully. You could be injured by fire or electrical shock if you do not follow these assembly instructions.</p>	

The appropriate power cable is included, depending on the regional version (USA, continental Europe, the UK or Australia).

	 <b>WARNING</b>
<p>Only use the proper power cable that is permitted in your country. Be sure to use the correct plug shape (refer to Figure 5).</p>	

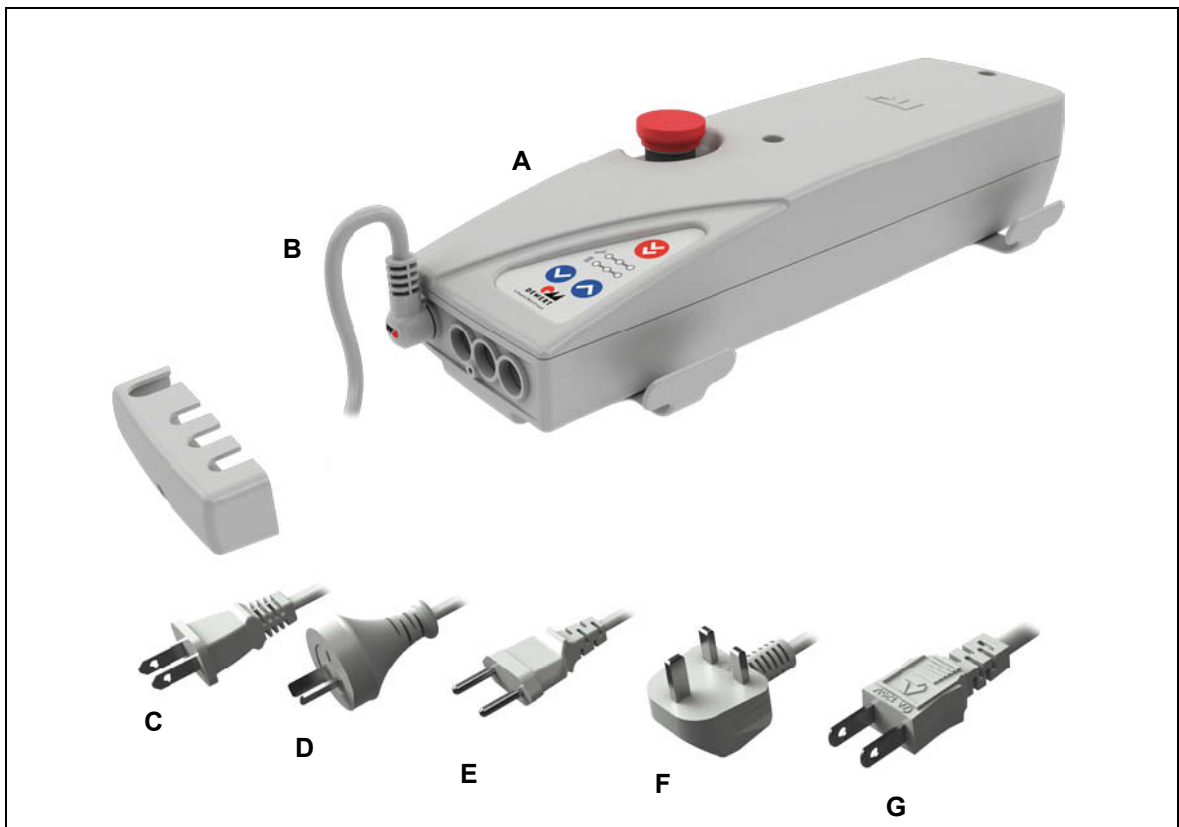

Figure 5 Variants of the power supply cable (examples)

- |   |   |
|---|---|
| <b>A</b> ACCUCONTROL                          | <b>B</b> Power cable                          |
| <b>C</b> Mains power plug (USA version)       | <b>D</b> Mains power plug (Australia version) |
| <b>E</b> Mains power plug (EURO plug version) | <b>F</b> Mains power plug (UK version)        |
| <b>G</b> Mains power plug (Japanese version)  |   |

## 5. Technical specifications

	ACCUCONTROL 3.0	ACCUCONTROL 3.0 XL
Input voltage		24 V DC
	100 – 240 V AC 50/60 Hz	100 – 240 V AC 50/60 Hz
	230 V AC 50/60 Hz	230 V AC 50/60 Hz
Input current		Max. 0.8 A
	0.2 – 0.1 A	0.2 – 0.1 A
	0.1 A	0.1 A
Mode of operations <sup>1</sup>	Intermittent duty 2 min./18 min.	Intermittent duty 2 min./18 min.
Permitted power consumption	Max. 8.5 A DC	Max. 8.5 A DC
Power limit (over-current shutdown)	Adjustable to 8.5 A DC	Adjustable to 8.5 A DC
Audible alarm threshold	21 V DC	21 V DC
Shutdown threshold discharge	17 V DC	17 V DC
Rated voltage of the battery	24V DC	24V DC
Capacity	3.0 Ah	3.0 Ah (optionally 4.5 Ah)
Fuse	7.0 A (PolySwitch)	7.0 A (PolySwitch)
Battery type	Lead rechargeable battery (Pb)	Lead rechargeable battery (Pb)
Self-discharging	After approx. 6 months	After approx. 6 months
Charging time	approx. 6 hours at 3.0 Ah	approx. 6 hours at 3.0 Ah approx. 8 hours at 4.5 Ah
Protection degree	IPX4	IPX4, optionally IPX6
<b>Dimensions and weight</b>		
<b>Length x width x height</b>		
ACCUCONTROL (with shield cover pull-out protection)	454 mm x 124 mm x 104 mm	454 mm x 124 mm x 104 mm
<b>Weight</b>		
ACCUCONTROL	Approx. 4.3 kg	Approx. 4.3 kg

<sup>1)</sup> Mode of operation: intermittent duty 2 min./18 min. This means that after the unit is operated with its rated load for up to 2 minutes it must then be paused for 18 minutes. The system can malfunction if this pause is not observed!

<b>PLUG-IN-CHARGER</b>	
Input voltage	100 – 240 V AC 50/60 Hz
	230 V AC 50/60 Hz
Charging voltage (nominal)	24 V DC
Charging current	approx. 750 mA
Discharge current	approx. 25 mA

<b>Ambient conditions for operation, storage and transport</b>	
Transport / storage temperature	From -20 °C to +50 °C
	From -4 °F to +122 °F
Operating temperature	From +10 °C to +40 °C
	From +50 °F to +104 °F
Relative humidity	From 30% to 75%
Air pressure	From 800 hPa to 1060 hPa
Height	< 2000 m

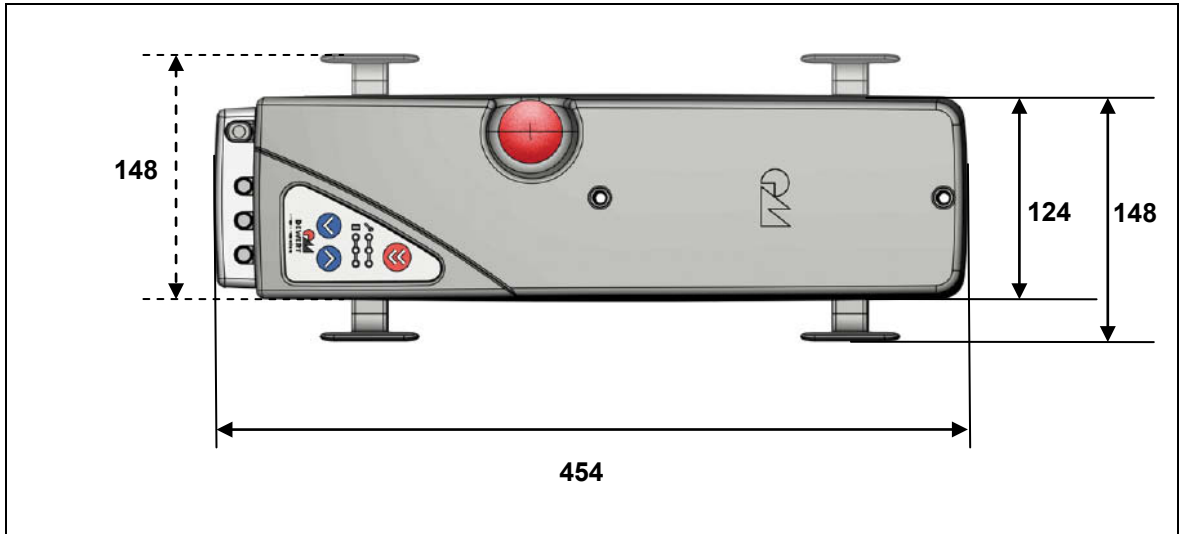

Figure 6 Dimensions of the ACCUCONTROL, top view (in mm)

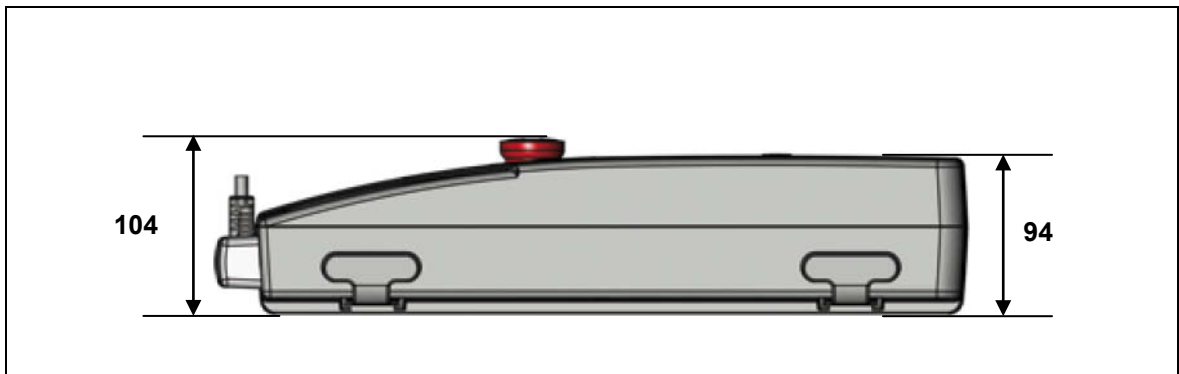



Figure 7 Dimensions of the ACCUCONTROL, side view (in mm)

## 6. Installation

### 6.1 Safety notices to observe during installation

Basic safety rules must be followed in order to ensure that the end product can be continually operated in a safe manner. These rules must be observed while using the end product and while installing the *ACCUCONTROL* in the end product.

#### 6.1.1 Resting interval for the ACCUCONTROL

	<b>NOTICE</b>
	<p>The following pause times for the <i>ACCUCONTROL</i> must be observed. The unit must not be in operation for at least 1 hour:</p> <ul style="list-style-type: none"> <li>• before commissioning</li> <li>• before its removal</li> </ul>

#### 6.1.2 Avoiding electrical faults

The PLUG-IN CHARGER has a connecting cable. When sizing your end product, remember that the connecting cable must never be squashed (e.g. by moving over it) during operations.

#### 6.1.3 Ensuring operational reliability during installation

The safety and reliability of the end product containing DewertOkin components can be ensured by using the proper construction methods as described below.

	<b>NOTICE</b>
	<p><b>Using original parts</b></p> <p>Use only DewertOkin components to ensure operational safety. When using a non-matched power supply, there is a risk that there is inadequate charging circuitry and that the batteries can be overcharged.</p>

## 6.2 Installation procedure

Before installing and connecting the *ACCUCONTROL*, make sure that you are observing all of the safety notices found in the "Safety notices to observe during installation" section.

### 6.2.1 Installation and dismantling for the control unit

The *ACCUCONTROL* can be screwed to the end product at its two attachment points. Use M6 cylinder head screws, in accordance with DIN EN ISO 4762, with suitable length (we recommend 85 mm plus the screw-in depth into the end product). The *ACCUCONTROL* should be mounted so that it lies flat against its supporting base. In the end product, no mechanical forces (such as torsion) should be put on the *ACCUCONTROL* or its housing. Such forces could lead to damage (such as cracks) in the housing. Maximum tightening torque: 1.5 Nm (This tightening torque applies only to this screw. The tightening torque for other screws may differ!).

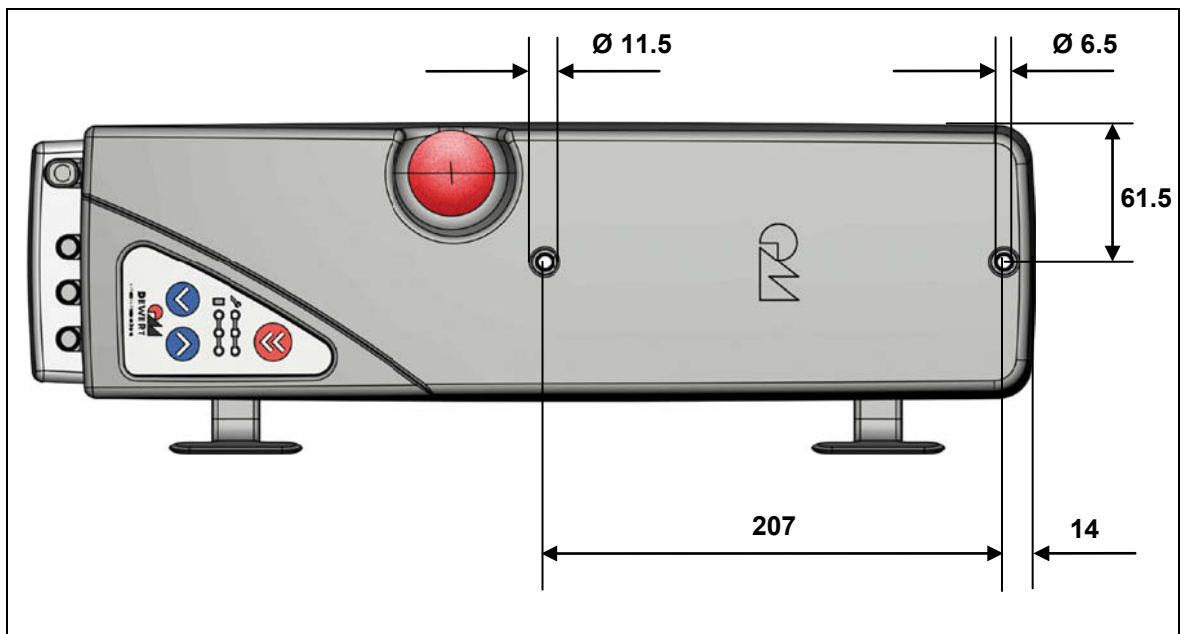

Figure 8 ACCUCONTROL mounting points (in mm)

6.2.2 Mounting the ACCUCONTROL onto the patient lifter

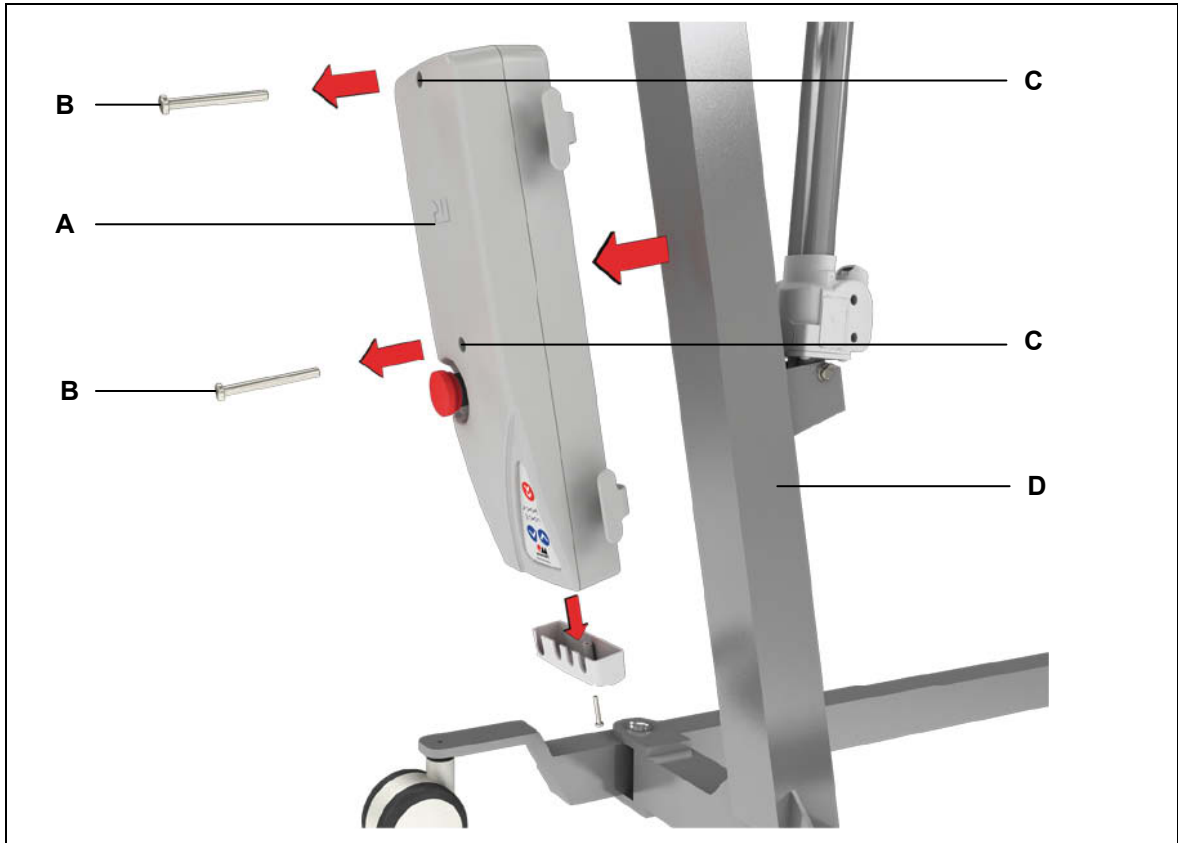



Figure 9 Installation onto the patient lifter (example)

- A** ACCUCONTROL
- B** Cylinder head screws M6 (recommendation: 85 mm plus the screw-in depth)
- C** Attachment points (use the screw holes in the housing of the ACCUCONTROL)
- D** Patient lifter
- E** Shield cover (pull-out guard)

Proceed as described below when installing the ACCUCONTROL onto the patient lifter:

<b>NOTICE</b>	
	<ul style="list-style-type: none"> <li>There must be sufficient space available to mount the unit!</li> <li>Always mount the ACCUCONTROL with the connecting ports facing down!</li> </ul>

- 1 Align the ACCUCONTROL on the patient lifter and mark the two attachment points (distance should be 207 mm).
- 2 Screw the ACCUCONTROL using the appropriate cylinder head screws (for example: M6x100-8.8 VZ) onto the patient lifter (refer to Figure 9).
- 3 Connect the components (handset, slave drives) and route the cables.
- 4 Install the shield cover (pull-out protection) and screw it to the ACCUCONTROL (maximum torque for this screw is 1.5 Nm).
- 5 Optional: Lay or wrap the mains connecting cable around the cable holders (on the left or right side of the ACCUCONTROL).

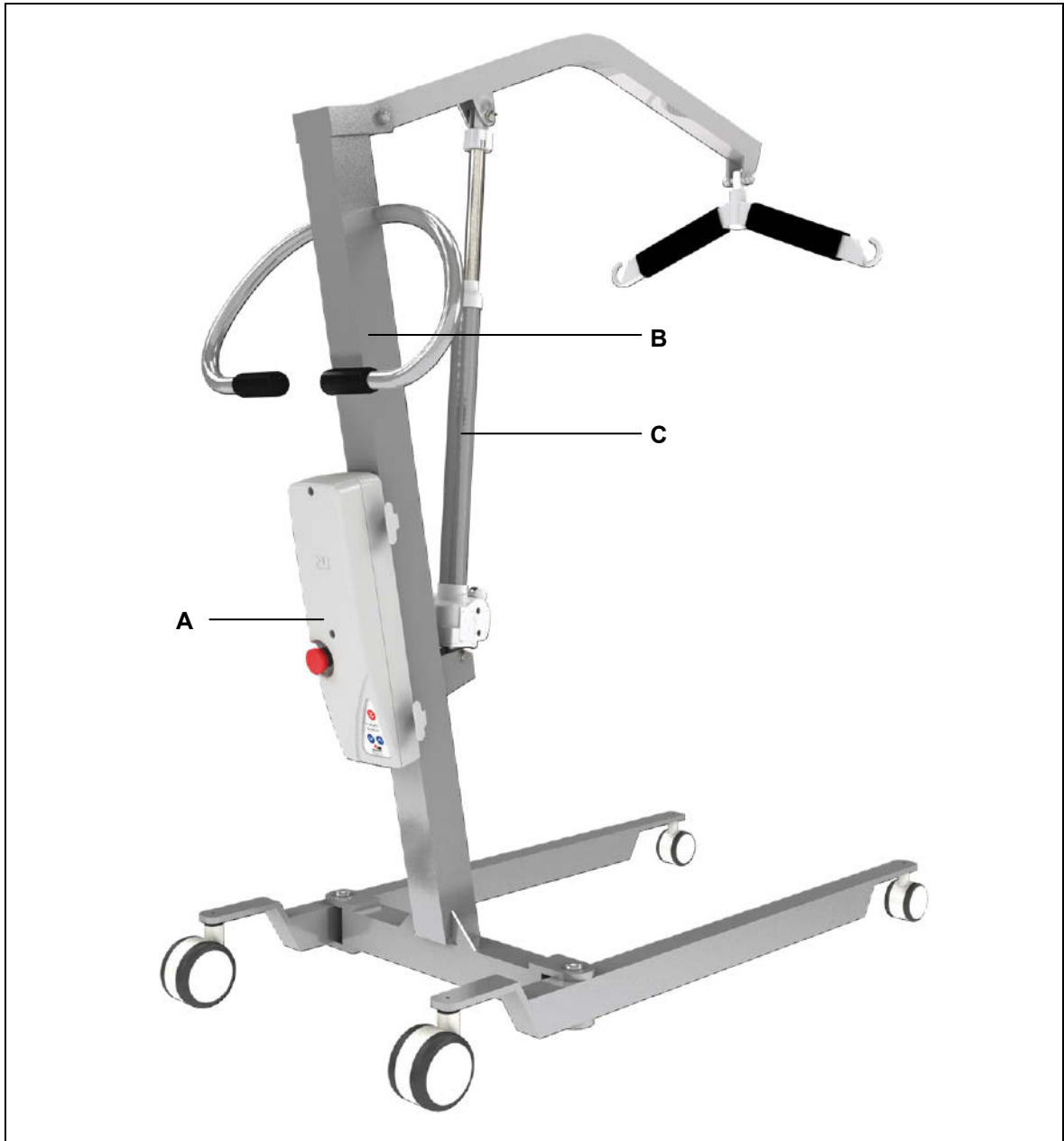

Figure 10 ACCUCONTROL on the patient lifter (example)

**A** ACCUCONTROL

**B** Patient lifter

**C** Stroke drive



### 6.2.3 Electrical connection

#### Routing the electrical cables

When routing the cables, be sure that:

- the cables cannot get jammed,
- no mechanical load (such as pulling, pushing or bending) will be put on the cables, and
- the cables cannot be damaged in any way.

Fasten all cables (especially the connecting cables) to the end product using sufficient kink prevention methods. Be sure that the design of the end product prevents the connecting cables from coming into contact with the floor during transport.

#### Connecting the components

When connecting the components:

- Be sure to connect all components (the drives, handsets, etc.).
- Make sure that unoccupied slots are sealed with dummy plugs, the shield cover (pull-out protection) has been mounted and the *ACCUCONTROL* is mounted on the patient lifter. Only in this condition can the IPX4 degree of protection (optionally IPX6) be guaranteed.

6.2.4 Removing the ACCUCONTROL from the patient lifter

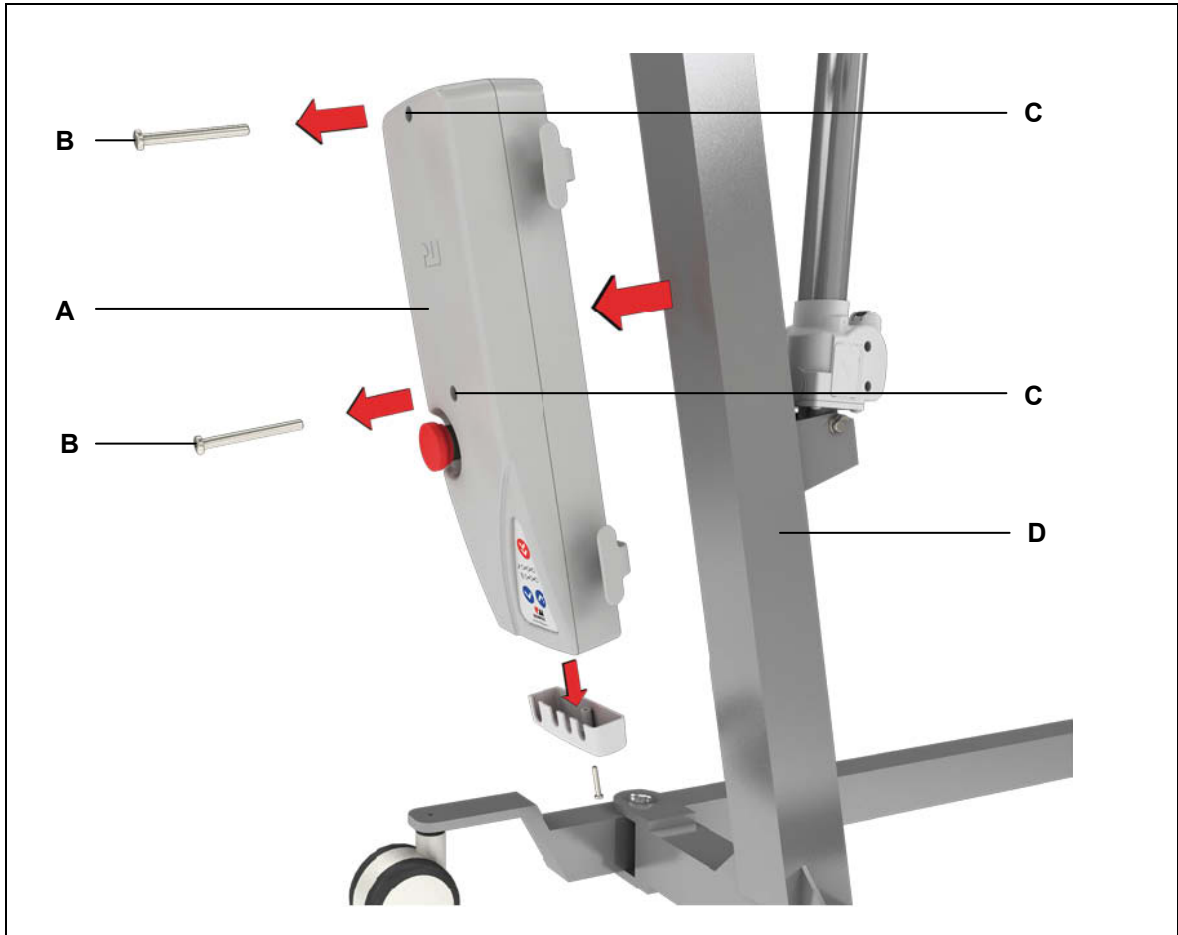



Figure 11 Dismantling from the patient lifter

- A** ACCUCONTROL
- B** Cylinder head screws M6
- C** Attachment points (screw holes of the ACCUCONTROL)
- D** Patient lifter
- E** Shield cover (pull-out guard)



- 1 Move the patient lifter into a position where it is subject to no load.
- 2 Remove the shield cover.
- 3 Disconnect the connecting cable from the ACCUCONTROL.

	<p><b>CAUTION</b></p>
<p>You should only connect and disconnect the cables when they are completely disconnected from any live current!</p>	

- 4 Loosen the two cylinder head screws at the attachment points of the ACCUCONTROL (refer to Figure 11).
- 5 Remove the ACCUCONTROL from the patient lifter.

## 7. Operating notes



The factual information contained within may be used when you are creating the end-product manual. The installation instructions do not contain all information required for the safe operation of the end product. They only describe the assembly and operation of the *ACCUCONTROL* as a partially assembled piece of machinery.

	 <b>CAUTION</b>
	When creating the operating instructions, remember that the installation instructions are intended for qualified specialists and are not for typical users of the end product.

### 7.1 General information



- ▶ Only components that have been approved from DewertOkin should be connected to the *ACCUCONTROL*; only approved components have been verified to work together. Ask your customer representative for more information.

#### Emergency-stop switch

	 <b>CAUTION</b>
	The emergency-stop switch must be accessible for all operational situations.

#### Inspecting before the initial commissioning and after external impacts

Heavy mechanical impacts (which may occur during transport or by dropped objects) can sometimes result in electrical malfunctions.

	 <b>CAUTION</b>
	<p>In order to improve the operational reliability, take the following steps before the initial commissioning and after any extreme mechanical loads:</p> <p>Check if the housing is damaged. If the housing shows signs of damage or if the device heats up excessively:</p> <ul style="list-style-type: none"> <li>• Immediately press the emergency-stop switch.</li> <li>• Stop using the drive.</li> </ul>



**Power-on time / intermittent operations**

The *ACCUCONTROL* has been designed for intermittent operations. Intermittent operation is an operational mode where the drive must pause after a specified maximum period of operation (power-on time). This protects the drive from overheating. Extreme overheating can cause a malfunction.

- ▶ The ratings plate specifies the maximum power-on time and the required pause intervals.

	<b>NOTICE</b>
	No more than two drives may be operated at rated load simultaneously!



**Avoiding electrical risks**

	 <b>CAUTION</b>
	Make sure that all live (current-carrying) parts of the drive system and power supply cannot be touched. In particular, be sure that unused power and control unit connections are covered adequately.

**Deep-discharge protection**



The drive system is completely deactivated whenever the voltage of the *ACCUCONTROL* has reached the shutdown threshold level. This deep discharge monitor protects the rechargeable battery from damages that could result when the discharge warning is ignored. The reset button on the control unit or handset (as described in sections 7.4.2 and 7.5.3) can be used once for lowering.

**Emergency shut off of a connected drive or control unit**

	 <b>CAUTION</b>
	Press the emergency-stop switch. The emergency-stop switch must be accessible for all operational situations.

**Avoiding cable damage**

Be sure that your operating instructions inform the user about the possible cable risks.

	 <b>CAUTION</b>
	The cables (and in particular the power supply cable and the connecting cable for the PLUG-IN CHARGER) may not be driven over. In order to prevent personal injury or damage to the <i>ACCUCONTROL</i> , no mechanical strain should be placed on the cables.

## 7.2 Programming the over-current shutdown mechanism when commissioning the system

<b>NOTICE</b>	
	<ul style="list-style-type: none"> <li>This programming must be carried out by the manufacturer of the end product. Do not forward the following description of action on to the end user.</li> <li>Carry out the programming (teach-in) for the <i>ACCUCONTROL</i> before its initial commissioning and after it has been serviced!</li> </ul>

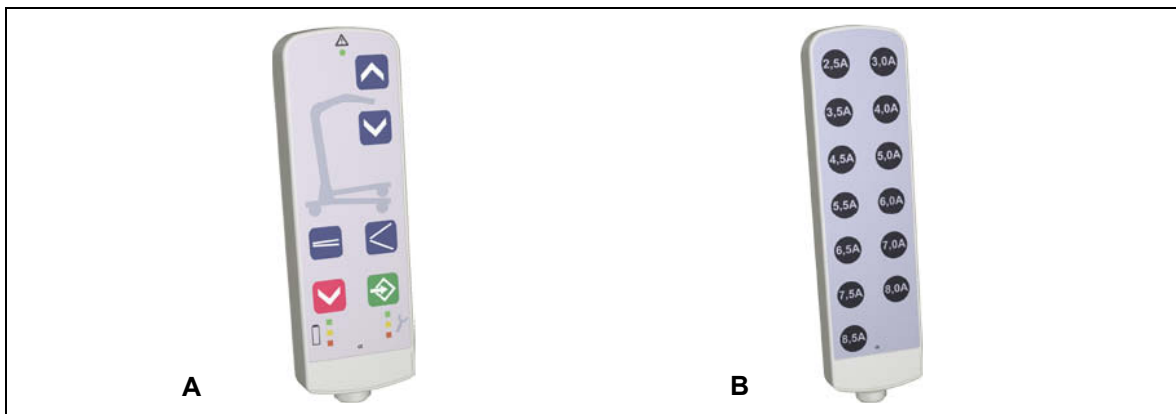



Figure 12 Variants of the handset

**A** IPROXX handset

**B** Programmer handset for the over-current detection

### a) Option 1: On the IPROXX handset

- 1 Attach an object to your end product (e.g. the patient lifter) that represents a specific overload.
- 2 Connect the IPROXX handset (**A**) to the *ACCUCONTROL*.
- 3 Press the button  on the IPROXX handset (**A**). The stroke drive moves automatically as long as the button is held down. The over-current shutdown mechanism is programmed in this way.
- 4 A beep tone signals that this process has been completed.

### b) Option 2: On the programmer handset for the over-current detection

- 1 Use your test system to determine the values for the over-current shutdown. The programmer handset (**B**) has buttons which specify the different current values for the over-current shutdown. All control units in this series can be programmed with one touch to the specified value.
- 2 Connect the programmer handset to the *ACCUCONTROL*.
- 3 Press (and hold down for at least 3 seconds) the button on the programmer handset that corresponds to the determined value. The *ACCUCONTROL* is then automatically programmed.
  - ▶ Depending on your actual system, the completed programming is confirmed by an acoustic signal and/or an illuminated red service LED (as shown in Figure 22) on the *ACCUCONTROL*.
  - ▶ If the programmed value for the over-current shutdown is reached or exceeded during operations, then the over-current shutdown mechanism triggers and the drives cannot be run. You should then reduce the load or move the drives down.

## 7.3 ACCUCONTROL

### 7.3.1 General safety instructions for the ACCUCONTROL

- Do not open or destroy the *ACCUCONTROL*.
- The *ACCUCONTROL* may only be charged as shown in Figure 13 or Figure 14 (pages 32 and 33).
- Do not expose the *ACCUCONTROL* to heat or open flame. Do not store it in direct sunlight.
- If the batteries leak and you come into contact with the leaked fluid, wash yourself with plenty of water and seek medical attention immediately.
- The *ACCUCONTROL* may only be used properly as intended.
- Keep the *ACCUCONTROL* out of the reach of children.
- Do not throw the *ACCUCONTROL* into fire or open it. Do not solder or weld on the *ACCUCONTROL*.

	<b>NOTICE</b>
<p>The following pause times for the <i>ACCUCONTROL</i> must be observed. The unit must not be in operation for at least 1 hour:</p> <ul style="list-style-type: none"> <li>• before commissioning,</li> <li>• before its removal.</li> </ul>	

	<b>NOTICE</b>
<p><b>Using original parts</b></p> <p>Use only DewertOkin components to ensure operational safety. Using an improper, non-matched power supply increases the risk of overcharging the batteries.</p>	

## 7.4 Charging the ACCUCONTROL

The *ACCUCONTROL* is charged using the mains power cable or the PLUG-IN CHARGER. The following applies to both variants of the *ACCUCONTROL*:

Charging	
ACCUCONTROL AC 3.0	<ul style="list-style-type: none"> <li>• Charge using the mains power cable</li> </ul>
ACCUCONTROL AC 3.0 XL	<ul style="list-style-type: none"> <li>• Charge using the main power cable or</li> <li>• Charge using the external PLUG-IN CHARGER</li> </ul>

NOTICE	
	<p>Charge the <i>ACCUCONTROL</i> using the mains power cable or the PLUG-IN CHARGER; these have been tested to work with the device.</p> <p>Note the following information when charging:</p> <ul style="list-style-type: none"> <li>• Charge the <i>ACCUCONTROL</i> completely (for at least 10 hours) before first use. The installed rechargeable batteries achieve their full capacity only after 5 to 10 discharge cycles.</li> <li>• Depending on your model, the battery charge status is displayed on either the handset or on the <i>ACCUCONTROL</i> control unit.</li> </ul>

## 7.4.1 Charging the ACCUCONTROL on the patient lifter (variant with mains power cable)

	<b>NOTICE</b>
	No motion functions are possible during the charging!



Figure 13 Charging the ACCUCONTROL (variant with mains power cable)

- |                      |   |
|----------------------|---|
| <b>A</b> Power cable | <b>B</b> Cable holder   |
| <b>C</b> ACCUCONTROL | <b>D</b> Connecting port for the mains power cable on the ACCUCONTROL |

► Steps 1 – 3 are **only taken** during the initial commissioning.

- 1 Initial commissioning:** Remove the shield cover (pull-out protection) if it is already mounted.
- 2 Initial commissioning:** Connect the power supply cable, handset and slave drives to the *ACCUCONTROL*, as shown in Figure 3.
- 3 Initial commissioning:** Mount the shield cover (the maximum torque for this screw is 1.5 Nm).
- 4** Insert the cable's power plug into a power outlet.
- 5** The charge state of the *ACCUCONTROL* is indicated by its LED:
  - LED is flashing green: The *ACCUCONTROL* is charging,
  - LED is steady green: The *ACCUCONTROL* is fully charged.
- 6** If the LED on the *ACCUCONTROL* is lit continually green:
  - Unplug the power supply from the power outlet.
  - Then wrap the power cable around the cable holder (**B**).



7.4.2 Charging the ACCUCONTROL directly at the patient lifter (for variant with the PLUG-IN CHARGER)

	<b>NOTICE</b>
No motion functions are possible during the charging!	

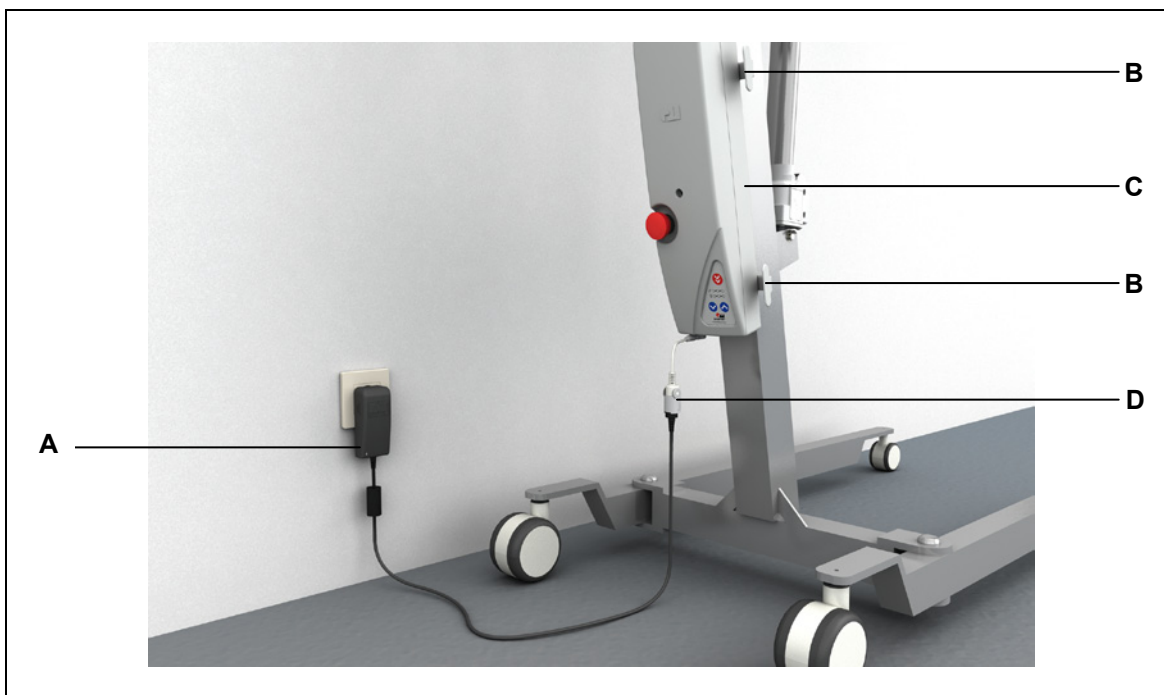

Figure 14 Loading the ACCUCONTROL with the PLUG-IN CHARGER

- |   |  |
|---|--|
| <p><b>A</b> PLUG-IN CHARGER</p> <p><b>C</b> ACCUCONTROL</p> | <p><b>B</b> Cable holder</p> <p><b>D</b> Connection for the PLUG-IN CHARGER (also refer to Figure 4)</p> |
|---|--|

- ▶ Steps 1 – 3 are **only taken** during the initial commissioning.
- 1 Initial commissioning:** Remove the shield cover (pull-out protection) if it is already mounted.
- 2 Initial commissioning:** Connect the handset and slave drives to the *ACCUCONTROL*, as shown in Figure 4.
- 3 Initial commissioning:** Mount the shield cover (the maximum torque of this screw is 1.5 Nm).
- 4** Connect the PLUG-IN CHARGER to the connecting cable using the locking cap (**D**), as shown in Figure 14.
- 5** Screw on the locking cap (**D**). The locking cap then engages.
- 6** Plug the PLUG-IN CHARGER into the socket.
- 7** The charge state of the *ACCUCONTROL* is indicated by the LED on the PLUG-IN CHARGER:
  - LED is flashing green: The *ACCUCONTROL* is charging,
  - LED is steady green: The *ACCUCONTROL* is fully charged.
- 8** If the LED on the PLUG-IN CHARGER is continually lit green:
  - Unplug the PLUG-IN CHARGER from the socket
  - Open the locking cap (**D**)
  - Unplug the connecting cable of the PLUG-IN CHARGER from the *ACCUCONTROL*.

### 7.5 Keypad for the ACCUCONTROL

The *ACCUCONTROL* has a keypad with the reset function button, a display for the battery charge state and a service indicator.

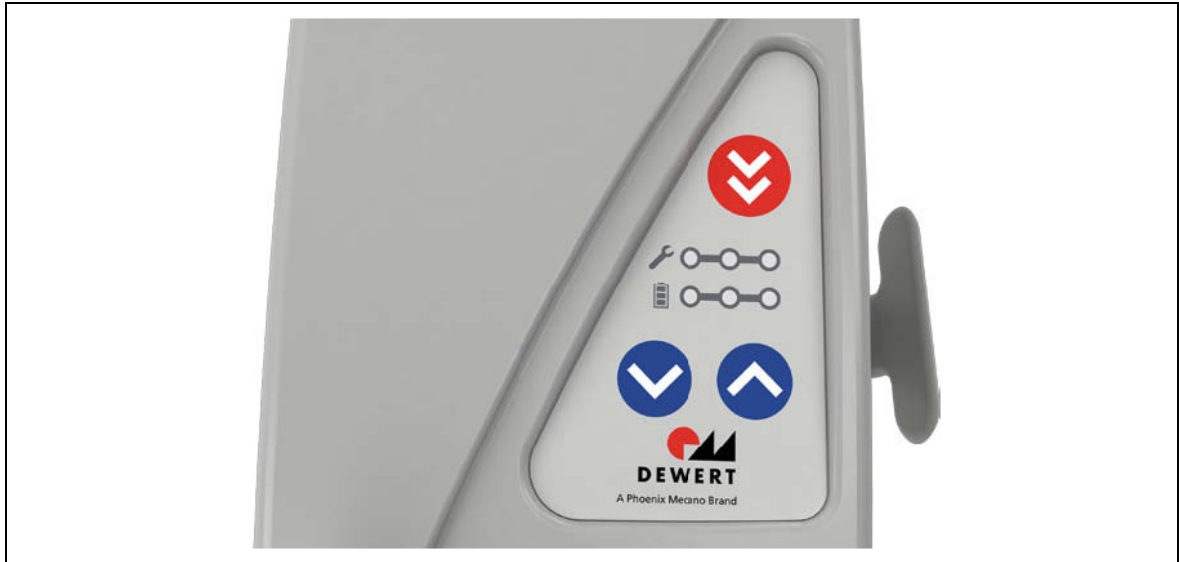

Figure 15 Keypad for the ACCUCONTROL 3.0 and ACCUCONTROL 3.0 XL

Button	Function
	Reset function <sup>1)</sup>
	Move down
	Move up

<sup>1)</sup> The button activates a separate circuit for lowering the main adjusting drive. This circumvents any protection mechanism in the *ACCUCONTROL* except for the emergency stop function.

Display	Function
	Service indicator
	Charge level indicator

7.5.1 Charge level indicator

Charge level indicator	Charge state	Measure / Action
Green	100% charged	
Green / yellow	Approx. 75% loaded	
Yellow	Approx. 50% loaded	
Yellow / dark orange	Almost completely discharged	Recharge the battery very soon.
Dark Orange	Completely discharged	Recharge the <i>ACCUCONTROL</i> <b>immediately</b> or the lifespan of the battery may be shortened. A red light and an audible signal indicate that a button has been pressed. One complete adjustment cycle is still possible.

7.5.2 Service indicator

Service indicator	Explanation for servicing
Green	There are no malfunctions of the drive system
Yellow	There are no malfunctions of the drive system <ul style="list-style-type: none"> <li>• Service is necessary in the near future</li> <li>• End of battery lifespan will be reached soon <b>or</b></li> <li>• End of drive lifespan will be reached soon</li> </ul> It is possible to continue to use the drive system.
Dark Orange	Check the drive system <ul style="list-style-type: none"> <li>• Replace defective components</li> </ul>
Dark orange and three acoustic beep signals	Drive: The end of the lifespan has been reached. <ul style="list-style-type: none"> <li>• After every fifth commissioning of the drive system, three beeps (each lasting one second) are emitted.</li> </ul> It is possible to continue to use the drive system.



**7.5.3 Servicing (if the service indicator is lit dark orange)**

If the service indicator lights up dark orange in combination with the acoustic beep signal, we recommend replacing or inspecting the following components:

Components	Measure / Action
All components of the ACCUCONTROL drive system	<ul style="list-style-type: none"> <li>• Visual inspection of cables and connectors</li> <li>• Visual inspection for housing damage</li> <li>• Check electrical function</li> <li>• Check the electrical emergency lowering function (by pressing the emergency lowering button)</li> <li>• Check for proper function of emergency-stop switch</li> </ul>

**7.5.4 Resetting the service indicator after the stroke drive has been replaced**

	<p><b>NOTICE</b></p> <p>Reset the service display only after all of the maintenance measures (as listed in the table above) have been successfully carried out.</p>
--	---

- 1 Simultaneously press the two buttons on the lifting drive (button  and button  ) (for about 10 seconds) until the signal beep sounds and the LED flashes dark orange.
- 2 Release both buttons. The green LED lights up after the buttons are released.

### 7.6 Buttons and indicators on the IPROXX 2 handset (an example)

Custom IPROXX handsets can be delivered for use with the patient lifter. The IPROXX PRO model is used for the example below. (For the IPROXX BAS handset, there is no reset function, no over-current shutdown, and no service or battery charge indicators).

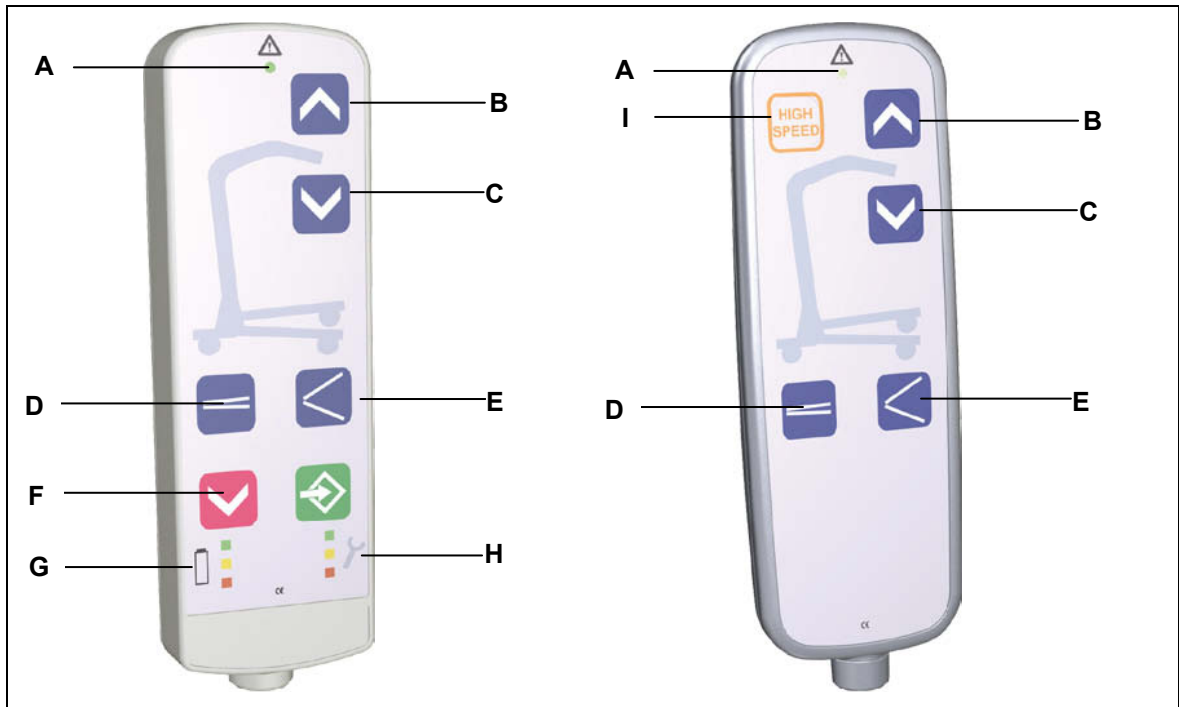

Figure 16 IPROXX 2 handset (example)



- A** Function LED
- B** Lifting motor button: up
- C** Lifting motor button: down
- D** Optional: Button: spread close
- E** Optional: Button: spread open
- F** Button: reset function
- G** Charge level indicator
- H** Service indicator
- I** High Speed

► The function LED (**A**) illuminates whenever a button is pressed. If the green function LED lights up continuously or does not light up when a button is pressed, this indicates that there is an error.

Button	Function	Key / indicator	Function
	Up		Reset function,
	Down		Charge level indicator
	Spread open		Service indicator
	Spread closed		High Speed

► Ask your customer representative for more information about other variants.

### 7.7 Emergency-stop switch

	 <b>CAUTION</b>
	<p>The emergency-stop switch must always be accessible during operations so that it can be quickly pressed in an emergency.</p>

The emergency-stop switch deactivates all functionality.





Figure 17 Emergency stop switch on the ACCUCONTROL

**A** Emergency-stop switch

	<b>NOTICE</b>
	<p>Make sure that the emergency-stop switch is not activated (pressed) during the initial commissioning!</p>

## 8. Troubleshooting

This chapter describes troubleshooting methods for fixing problems. If you experience an error that is not listed in this table, please contact your customer support representative.

	 <b>CAUTION</b>
	<p>Only qualified specialists who have received electrician training should carry out troubleshooting and repairs.</p>

Problem	Possible cause	Solution
The drive, handset or control unit is not functioning.	The drive, handset or control unit is defective.	Contact your customer support representative.
	There is no battery voltage.	Make sure the <i>ACCUCONTROL</i> is fully charged.
	The emergency-stop switch is pressed down.	Release the emergency-stop switch.
	The charger or power cable is connected and operating.	Remove the charger or pull the power cable from the socket.
The drive is suddenly not capable of movement.	The system protective circuit breaker has triggered.	Remove the overload (change or remove the load). Allow the system to rest for 20 to 30 minutes with the mains power unplugged. Contact your customer support representative if you cannot solve the problem.
	The over-current circuit shutdown mechanism in the control unit has triggered.	Reduce the load on the patient lifter.
	A cable has been disconnected (to a drive or control keypad).	Check the cables and reinsert them, if required.
The function LED on the handset does not light up or lights continuously when a key is pressed.	There is an error in the control system.	Contact your customer support representative.
	End position has been reached.	Move the drive from its end position.
	Drive load has been exceeded.	Take load off drives.
	Battery is fully discharged.	<i>Connect the ACCUCONTROL for charging</i>

## 9. Maintenance

- ▶ You should only use spare parts which have been manufactured or approved by DewertOkin. Only these parts will guarantee a sufficient level of safety.

### 9.1 Maintenance

Type of check	Explanation	Time interval
Make sure that no drive movements are carried out during the charging process.	The inspection may only be carried out by qualified personnel!	At least every six months.
Check the electrical, safety and emergency-stop functionality.	A qualified electrician should carry out this inspection. (Refer to the "Electrical connection" section in the "Installation" Chapter.)	Periodic inspections can be carried out at intervals based on the risk assessment which you conduct for your end product.
Look over the housing periodically for any signs of damage.	Check the housing for breaks or cracks.	At least every six months.
Look over the plug-in connections and electrical access points for signs of damage.	Check that all electrical cables and connections are firmly seated and correctly positioned.	At least every six months.
Look over the cables for any signs of damage.	Check the connecting cables for pinching or shearing. Also check the strain relief and kink protection mechanisms, in particular after any mechanical load.	At least every six months.



## 9.2 Cleaning and care

The *ACCUCONTROL* is easy to clean. Its smooth surfaces simplify the cleaning process.

	<b>NOTICE</b>
	<ul style="list-style-type: none"> <li>Never clean the <i>ACCUCONTROL</i> in an automated washing system or with a high-pressure cleaner. Do not allow fluids to penetrate the lighting. Damage to the system could result.</li> <li>Do not use a cleanser that contains benzene, alcohol or similar solvents.</li> <li>Only clean the <i>ACCUCONTROL</i> when it is mounted to the application (so that IPX4/IPX6 protection is guaranteed).</li> <li>Do not point the jet of water at the pressure compensation element.</li> </ul>

- 1 Be sure to unplug the drive cable on the *ACCUCONTROL* before you begin cleaning it! (Use dummy plugs to close any open sockets!)
- 2 Clean the *ACCUCONTROL* with a moist cloth.
- 3 Be sure that you do not damage the connecting cables during the cleaning.

## 9.3 Maintenance and care

### 9.3.1 Maintenance information

- Plastic surfaces (such as the housing surface) should only be cleaned with a damp cloth.
- Charge the *ACCUCONTROL* before you use it. Use a DewertOkin power cable or a PLUG-IN CHARGER, depending on your version. The integrated charging circuit automatically ensures that the battery is optimally charged.
- After the unit has been in storage for a long time, it may be necessary to charge the battery more than once before the complete capacity is restored.
- The storage time should not be longer than six months at the recommended storage temperature. The *ACCUCONTROL* should be recharged after this time. At higher storage temperatures, the battery should be recharged more frequently. This will help to prevent a complete discharge of the battery, which would damage it irreparably.

### 9.3.2 Care instructions

The lead-acid batteries are maintenance-free. As with any rechargeable battery, the lifespan of the *ACCUCONTROL* is limited. The actual lifespan is very dependent on the battery maintenance. In order to achieve the maximum lifespan for the battery, observe the battery level indicator and charge the batteries after any prolonged storage time (6 months storage should not be exceeded).

- Always keep the *ACCUCONTROL* clean and dry. Do not short circuit the *ACCUCONTROL*. Store the *ACCUCONTROL* so that its connection and sockets cannot be short-circuited by metallic objects.
- Do not expose the *ACCUCONTROL* to mechanical shocks.
- Only use the recommended power cable or charger.
- Do not use organic solvents (thinning solvents, alcohol, oil, rust inhibitors or surface-active agents such as chemical cleaners, etc.) on the *ACCUCONTROL*.
- Retain the original documents for any future inquiries.
- The best battery capacity is achieved when the *ACCUCONTROL* is used at normal room temperatures (from 20°C to 25°C).
- The *ACCUCONTROL* should not be submerged in water. It should be stored in a dry, cool place with a relative humidity of 50%.
- Only use the *ACCUCONTROL* for its specified purpose.

## 10. Disposal

### 10.1 Packaging material

The packaging material should be sorted into recyclable components and then disposed of in accordance with the appropriate national environmental regulations (in Germany according to the recycling law KrWG from 01.06.2012; internationally according to the EU Directive 2008/98/EC (Waste Framework Directive WFD as of 12.12.2008)).

### 10.2 Components of the ACCUCONTROL

The *ACCUCONTROL* consists of electronic components, cables and metal and plastic parts. You should observe all corresponding national and regional environmental regulations when disposing of the *ACCUCONTROL*.

The disposal of the product is regulated in Germany by Elektro-G, internationally by the EU Directive 2012/19/EC (WEEE), or by any applicable national laws and regulations.



The *ACCUCONTROL* should not be disposed of with normal household waste!

### 10.3 Batteries

The disposal of the rechargeable battery is regulated in the EU by the Battery Directive 2006/66/EC, in Germany by the BattG battery law of 25.6.2009, and internationally by any applicable national laws and regulations.

## EG-Konformitätserklärung

Nach Anhang IV der EMV-Richtlinie 2014/30/EU

Nach Anhang IV der EU-Niederspannungsrichtlinie 2014/35/EU

Nach Anhang VI der RoHS-Richtlinie 2011/65/EU (inkl. Delegierte Richtlinie (EU) 2015/863)

Der Hersteller

## EU Declaration of Conformity

*In compliance with Appendix IV of the EMC-Directive 2014/30/EU*

*In compliance with Appendix IV of the LVD-Directive 2014/35/EU*

*In compliance with Appendix VI of the EU RoHS Directive 2011/65/EU (incl. Commission delegated Directive (EU) 2015/863)*

*The manufacturer*

DewertOkin GmbH  
Weststraße 1  
32278 Kirchlegern  
Deutschland - Germany

erklärt hiermit, dass das Produkt

*declares that the following product*

### **ACCUCONTROL 3.0<sup>1)</sup>** **ACCUCONTROL 3.0 XL<sup>1)</sup>**

die Anforderungen folgender EG-Richtlinien erfüllt:

*meets the requirements of the following EU directives:*

**Richtlinie über elektromagnetische Verträglichkeit 2014/30/EU**

**Electromagnetic Compatibility Directive 2014/30/EU**

**Niederspannungsrichtlinie 2014/35/EU**

**Low Voltage Directive 2014/35/EU**

**DELEGIERTE RICHTLINIE (EU) 2015/863 DER KOMMISSION vom 31. März 2015 zur Änderung von Anhang II der Richtlinie 2011/65/EU des Europäischen Parlaments und des Rates hinsichtlich der Liste der Stoffe, die Beschränkungen unterliegen.**

**COMMISSION DELEGATED DIRECTIVE (EU) 2015/863 of 31 March 2015 amending Annex II to Directive 2011/65/EU of the European Parliament and of the Council as regards the list of restricted substances.**

Angewendete Normen

*Applied standards:*

- EN 60601-1:2006+A1:2013<sup>2)</sup>
- EN 55014-1:2006/A1:2009/A2:2011
- EN 55014-2:1997/A1:2001/A2:2008
- EN 61000-3-2:2014
- EN 61000-3-3:2013
- EN 62233:2008
- EN 60601-1-2:2015<sup>3)</sup>

Konstruktive Änderungen, die Auswirkungen auf die in der Montageanleitung angegebenen technischen Daten und den bestimmungsgemäßen Gebrauch haben, das Produkt also wesentlich verändern, machen diese Konformitätserklärung ungültig!

*This declaration of conformity is no longer valid if constructional changes are made which significantly change the drive system (i.e., which influence the technical specifications found in the instructions or the intended use)!*

Kirchlegern, Germany 25 November 2019



Dr.-Ing. Josef G. Groß  
Geschäftsführer / Managing Director

<sup>1)</sup> mit DewertOkin Antriebssystem / *with DewertOkin drive system*

<sup>2)</sup> Kurzbegriff: Edition 3.1 / *short description: Edition 3.1*

<sup>3)</sup> Kurzbegriff: Edition 4.0 / *short description: Edition 4.0*

## Additional information

The following standards have been applied for the patient lifter as used for transporting patients with handicaps – in accordance with:

- EN ISO 10535:2006 "lifter as used for transporting patients with handicaps":

EN ISO 10535, Section 4.3.1.24	Protection: min IPX4
EN ISO 10535, Section 4.3.1.17	Control with button
EN ISO 10535, Section 4.3.1.14	Easy-to-use controls
EN ISO 10535, Section 4.3.1.15	Control with lock switch / emergency-stop switch
EN ISO 10535, Section 4.3.1.16	Control with warn mechanism
EN ISO 10535, Section 4.3.1.23	Electromagnetic compatibility
EN ISO 10535, Section 4.3.1.18	Overload current switch-off

The following standards have applied for the models ACCUCONTROL 3.0 and ACCUCONTROL 3.0 XL with min IPX4 – in accordance with:

- EN 60601-1:2006+A1:2012, IEC 60601-1:2005+A1:2012 (short description: Edition 3.1), Medical electrical equipment.

IEC/EN 60601-1, Section 4	General requirements
IEC/EN 60601-1, Section 6	Classification
IEC/EN60601-1, Section 8	Protection against electrical danger
IEC/EN60601-1, Section 11.1	Overheating protection
IEC/EN60601-1, Section 11.2	Fire prevention
IEC/EN60601-1, Section 11.3	Design requirements for fire-resistant housing
IEC/EN60601-1, Section 13	Dangerous situations and error conditions
IEC/EN60601-1, Section 15.3	Mechanical attachment
IEC/EN60601-1, Section 15.4	Components and general construction
IEC/EN60601-1, Section 15.4.4	Indicator
IEC/EN60601-1, Section 16.6	Leakage current
IEC/EN60601-1, Section 17	Electromagnetic compatibility

DewertOkin GmbH  
Weststraße 1  
32278 Kirchlengern, Germany  
Tel: +49 (0)5223/979-0  
Fax: +49 (0)5223/75182  
<http://www.dewertokin.de>  
[Info@dewertokin.de](mailto:Info@dewertokin.de)

ID-Nr.: 89535