

DUOMAT 3 CARE EASY

Installation Instructions

(Translation of the original installation instructions)

Foreword

Document revision history

Version	Date	Modification, change
(-)	02/14	First release

Disclaimer and exclusion of liability

DewertOkin is not responsible for damage resulting from:

- failure to observe these instructions,
- changes made to this product which have not been approved by DewertOkin, or
- the use of replacement parts which have not been approved or manufactured by DewertOkin.

Manufacturer's address

DewertOkin GmbH
 Weststraße 1
 32278 Kirchlengern, Germany
 Germany
 Tel: +49(0)5223/979-0
 Fax.: +49 0 522375182
<http://www.dewertokin.de>
Info@dewertokin.de

Creation of a complete operating instruction manual for the entire end product

These instructions are only intended to be used by the end-product manufacturer. They should not be given to the operator of the end product. The factual information contained within may be used as a basis when creating the end-product manual.

The warning and danger notices are best suited for use in the end product's manual. However it is not sufficient to simply follow these notices. You should also carry out an internal risk assessment for your end product. This can then be used as the basis for the safety notices in your manual.

These installation instructions do not contain all information required to safely operate the end product. They only describe the installation and operation of the drive as partially completed machinery.

The instructions are intended for the technicians responsible for manufacturing an end product and not for the operators of the end product.

Notice for customers in EU nations**German Inspection Authority (TÜV) testing label**

The construction of the DUOMAT 3 CARE EASY has been inspected by the German Inspection Authority (TÜV). The TÜV also monitors the production of the DUOMAT 3 CARE EASY. The official German TÜV label certifies this construction inspection and production monitoring.

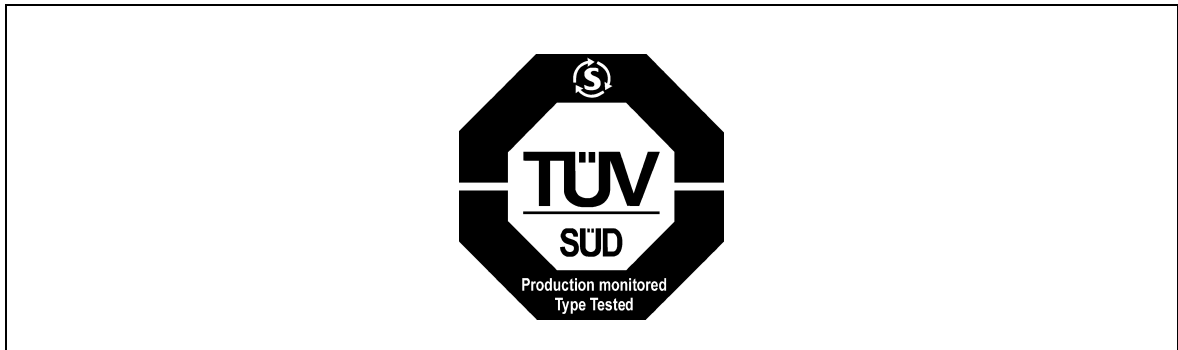

Figure 1 The TÜV label

Table of contents

Foreword	3
Document revision history	3
Disclaimer and exclusion of liability	3
Manufacturer's address	3
Creation of a complete operating instruction manual for the entire end product	3
Notice for customers in EU nations	4
Table of contents	5
1. General Information	7
1.1 About these installation instructions	7
1.2 Conventions used	7
2. Safety Instructions	8
2.1 Proper and Intended Usage	8
2.2 Safety notices within the installation instruction and the operating instructions for the entire machine	9
2.3 Selection and qualification of personnel	9
2.4 Notice on safety during operations	10
2.5 Product identification	11
3. Possible Combinations	12
4. Description	13
4.1 Components	13
5. Technical Specifications	15
6. Installation	17
6.1 Safety notices to observe during installation	17
6.2 Installation procedure	18
7. Operating Notes	24
7.1 General information	24
7.2 Notice for operating with optional configuration	26
8. Troubleshooting	27
9. Maintenance	28
9.1 Maintenance	28
9.2 Cleaning and care	29
78668(-)	5



10.	Disposal	30
10.1	Packaging material	30
10.2	Components of the DUOMAT 3 CARE EASY	30
10.3	Batteries	30
	Declaration of incorporation/installation	31
	EU Declaration of Conformity	32
	Additional information	33

1. General Information

1.1 About these installation instructions

These installation instructions must be followed closely in order to install this drive successfully and safely in the end product. These instructions are not an operating manual for the end product.

These instructions will help you to minimize danger, repair costs and down times. They will also help you to maximize the reliability and lifespan of the end product.

 CAUTION
<div style="display: flex; align-items: center;">  <div> <p>The notices in these instructions must be followed! Following the guidelines during installation and connection procedures will help to minimize:</p> <ul style="list-style-type: none"> • the risk of accident and injury, and • damage to the drive system or the end product. </div> </div>

These installation instructions have been written with due care and attention. However, we cannot guarantee that the data, images and drawings are complete and correct nor do we accept any liability for the information contained therein, unless required by law.



- ▶ We reserve the right to make unannounced technical changes in the course of our continual product improvement process!



1.2 Conventions used



Notices which do not relate to safety are indicated in these instructions with a triangle:

- ▶ Triangular notice symbol

Safety notice explanations

 WARNING
<div style="display: flex; align-items: center;">  <div> <p>WARNING indicates a hazardous situation which, if not avoided, could result in death or serious injury.</p> </div> </div>

 CAUTION
<div style="display: flex; align-items: center;">  <div> <p>CAUTION indicates a hazardous situation which, if not avoided, could result in minor or moderate injury.</p> </div> </div>



 NOTICE
<div style="display: flex; align-items: center;">  <div> <p>NOTICE is used to address practices which are not related to personal injury but may result in damage to the product or surroundings.</p> </div> </div>

2. Safety Instructions

2.1 Proper and Intended Usage



The DUOMAT 3 CARE EASY is meant to be installed in beds.



- They provide motor adjustment capabilities for movable reclining bed parts. They should be used in conjunction with suitable brackets and mechanics.
- for care purposes,
- or in hospitals.

	 CAUTION
	This drive should only be used for the applications described above. Any other form of usage is not permitted and can lead to accidents or destruction of the unit. Such non-approved applications will lead immediately to the expiration of all guarantee and warranty claims on the part of the end-product manufacturer against the manufacturer.

2.1.1 Improper usage

Be sure to follow the notices below concerning improper usage. You should include them in your product manual in order to inform the users of your end product.

	 WARNING
	The DUOMAT 3 CARE EASY may not be used: <ul style="list-style-type: none"> • in any environment where combustible or explosive gases or vapours (e.g., anaesthesiology) may be present, • in the proximity of open fires or other heat sources (such as furnaces, ovens or direct sunlight), • as a power source for toys or games, • in any application that will be cleaned with an automated washing system, • for raising and lowering loads in industrial or technical applications, • in a moist environment, or • outdoors.

	 CAUTION
	The DUOMAT 3 CARE EASY should not be used <ul style="list-style-type: none"> • by small children, • by frail or infirm persons without supervision, or • in the proximity of small children.

The DUOMAT 3 CARE EASY can be used by children of 8 years and older, persons with reduced physical, sensory or mental capabilities, or persons with lack of experience or knowledge when they are supervised or instructed concerning the safe use of the device and when they understand the resulting risks. Do not allow children to play with this device. The cleaning and user maintenance must not be carried out by children without supervision.

- ▶ You should only use spare parts which have been manufactured or approved by DewertOkin. Only these parts will guarantee a sufficient level of safety.



Using the drive systems in medical applications

This DewertOkin product is in compliance with the safety requirements found in IEC 60601-1.

We strongly recommend that the end product (including all its components) which you are manufacturing for a medical application should also be in compliance with the safety requirements found in IEC 60601-1.

You should make sure that the mechanical movement of the motor in your end product poses no risk of injury. Conduct a risk analysis for the end product for this purpose. You should also include safety notices in the instructions for the end product and technical safeguards in your product to eliminate any risk.

Optional: battery-operated reset function

	 CAUTION
The battery-operated reset function is not a safety system and does not avert danger.	

DewertOkin does not guarantee that the drive will function in the event of a power outage.

If the end-product manufacturer chooses to guarantee the functionality of the end product during a power outage, then the end-product manufacturer is responsible for arranging a mechanism to ensure this functionality.

2.2 Safety notices within the installation instruction and the operating instructions for the entire machine

The manufacturer of the end product is only permitted to operate the DUOMAT 3 CARE EASY (by itself an incomplete machine)

- when the end product (for which the DUOMAT 3 CARE EASY is intended) is in compliance with all protective measures specified in the Machinery Directive 2006/42/EC, and
- when the manufacturer expressly declares the compliance of the end product.

The manufacturer of the end product must create a manual for the users of that product. The safety notices in the end-product manual must be written based on the end product's risk assessment.

2.3 Selection and qualification of personnel

This drive should only be installed into the end product by someone who has completed training in electronic motor assembly or has equivalent qualifications.

You should only install this drive when you are qualified to do so. Otherwise, a properly qualified person should be found for this task.

2.4 Notice on safety during operations

Basic safety rules must be followed in order to ensure that the end product can be continually operated in a safe manner. These rules must be observed while using the end product and while installing the drive.

These rules and safety measures can be categorized as follows:

- Construction measures before the installation (refer to the "Safety notices to observe during installation" section in Chapter "Installation").
- Safety fundamentals during the drive installation and during cable and wire routing (refer to the "Safety notices to observe during installation" section in the "Installation" chapter).
- Using the drive in intermittent duty (refer to the "General information" section in the "Operating Notes" chapter).
- Basic safety rules during operation (refer to the "General information" Chapter).
- The creation of a manual for the end product which contains these and other safety rules.

Creating a user's manual

The manufacturer of the end product must create a manual for the users of that product. The safety notices in the end-product manual must be written based on the end product's risk assessment.

2.5 Product identification

2.5.1 Type plate

A ratings plate on each drive specifies the exact name and serial number of the drive. It also states the technical specifications valid for that particular drive. In particular, you will find the maximum pull force and the maximum push force here. The following illustration shows where the specifications are located on the drive's ratings plate.

- ▶ The ratings plate shown is an example; the specifications for your drive may differ from this illustration.

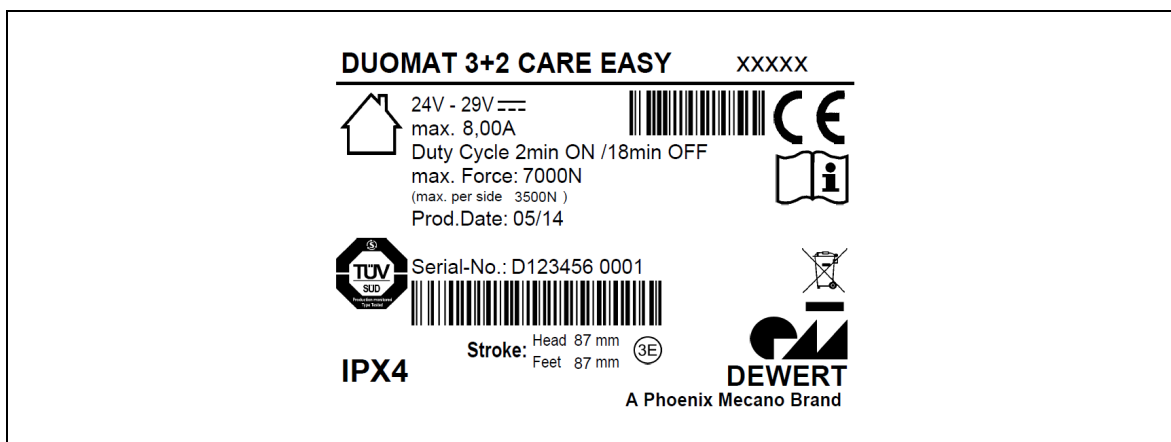





Figure 2 Ratings plate example

DUOMAT 3+2 CARE EASY	Model name
XXXXX	Article number
24V - 29V ~	Input voltage and frequency
Max. 8.00A	Rating of fuse
Duty Cycle 2min ON/18min OFF	Intermittent operations: 2 minutes / 18 minutes
Max. force	Push force
Prod.date	Calendar week / year
Serial No.	Serial number for your drive
IPX4	Protection degree
Stroke	Stroke (head / foot)
	Use in dry rooms only!
	Standards label: refer to additional information
	Follow all special disposal instructions!
	Conformity mark

3. Possible Combinations

The DUOMAT 3 CARE EASY double drive can be combined with other single drives. The following basic combinations are possible:

- a DUOMAT 3 CARE EASY with a IPROXX2 handset and a connected PD14/PD15 power supply,
- a DUOMAT 3 CARE EASY as the main drive with a IPROXX2 handset and one or two Megamat MCZ EASYs, as well as a connected PD14/PD15 power supply.

Systems can be customized by combining drives, power supplies and IPROXX2 handsets as needed.

DewertOkin has separate system instruction manuals containing the additional information and instructions needed for these systems. You can also find more information at www.dewertokin.de.

4. Description

The DUOMAT 3 CARE EASY is an electrically driven motor that is responsible for moving the end product in a linear direction. The head and foot sections of a bed can be adjusted depending on the drive options. The drive is controlled by means of a handset.

The different drive models vary according to the:

- model with optional reset function
- ▶ We reserve the right to make unannounced technical changes in the course of our continual product improvement process!
- ▶ The "Possible Combinations" chapter describes the different possible combinations of drives and handsets.

4.1 Components

The main components of the DUOMAT 3 CARE EASY are the electric motor and the adjustment motion mechanism. This mechanism is housed under the shutters. The shutters must be opened in order to mount the drive to the end product. The brackets fastened to the end product are then inserted into these openings.

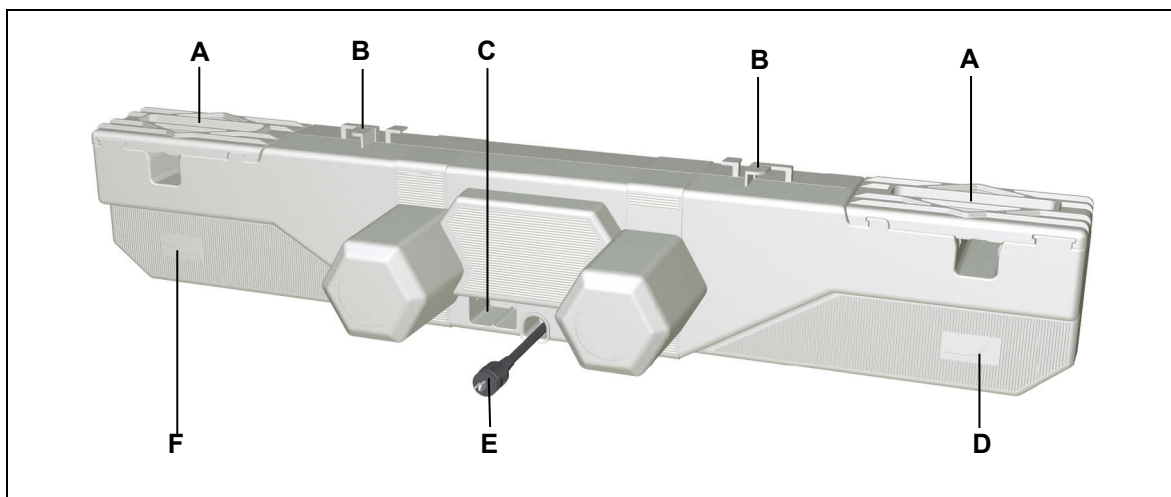

Figure 3 Main components of the DUOMAT 3 CARE EASY

- | | |
|--|-------------------------------------|
| A Shutters | B Strain relief |
| C Battery compartment for the nine-volt batteries | D Symbol for head end of bed |
| E Connecting cable to the PD14/PD15 power supply | F Symbol for foot end of bed |

4.1.1 Connection options

DUOMAT 3 CARE EASY with two connections



Figure 4 Connections located at the rear of the DUOMAT 3 CARE EASY

A LSP port for a single drive

B Handset port

DUOMAT 3 CARE EASY with three connections



Figure 5 Connections located at the rear of the DUOMAT 3 CARE EASY

A LSP port for a single drive 1

B LSP port for a single drive 2

C Handset port

5. Technical Specifications

Input voltage (DC)	24 – 29 VDC
Current consumption at rated load	Max. 8.0 A DC
Permitted push force	Max. 3500 N per side
Mode of operation ¹ under max. rated load.	Intermittent duty 2 min. ON / 18 min. OFF
Protection classification (EN 60335-1)	III
Meets the requirements of: Protection classification (EN 60601-1, 3 rd Edition)	II
Noise level	≤ 65 dB(A)
Drive type	Double drive
Protection degree	IPX4
Operating time	Approx. 10,000 switching cycles
Stroke ²⁾	87, 69 (standard)
Colours	Grey
Length x width x height	708 mm x 166 mm x 120 mm
Axle gap distance	581 mm
Weight	Approx. 4.4 kg
Optional: battery-operated reset function	
Voltage	Two nine-volt batteries (type 6LR61) depending on version
Ambient conditions for operation, storage and transport	
Transport / storage temperature	From -20 °C to +50 °C From -4 °F to +122 °F
Operating temperature	From +10 °C to +40 °C From +50 °F to +104 °F
Relative humidity	From 30% to 75%
Air pressure	From 800 hPa to 1060 hPa
Height	< 2000 m

¹ Mode of operation: intermittent duty 2 min./18 min. This means that after the unit is operated with its rated load for up to two minutes it must then be paused for 18 minutes. The system can malfunction if this pause is not observed!

² Other stroke distances are available on request.

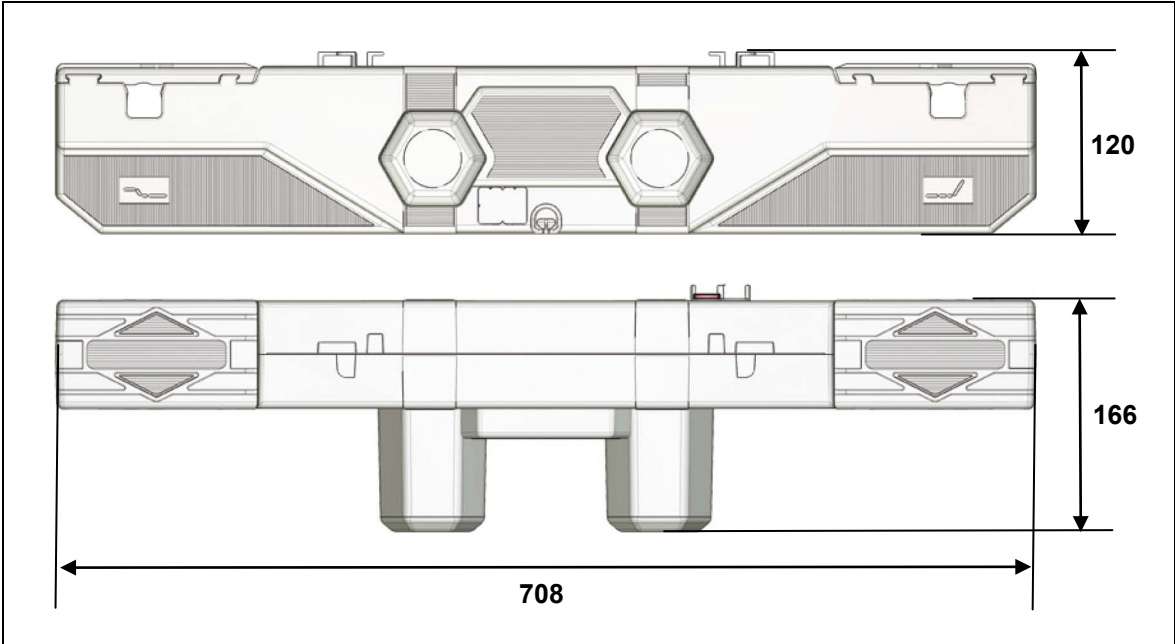

Figure 6 Dimensions of DUOMAT 3 CARE EASY (in mm)

6. Installation



6.1 Safety notices to observe during installation

Basic safety rules must be followed in order to ensure that the end product can be continually operated in a safe manner. These rules must be observed while using the end product and while installing the drive.



6.1.1 Ensuring operational reliability during installation

The safety and reliability of the end product containing the DewertOkin drive can be ensured by using the proper construction methods described below.

Avoiding fatigue fractures

 CAUTION
<div style="display: flex; align-items: center;">  <div> <p>Drives that are incorrectly installed can undergo fatigue fractures which then create a risk of injury.</p> <ul style="list-style-type: none"> • Install the drive in the end product so that it is properly aligned. This will help prevent shear stress. • Do not position the drive at a slanted angle when installing it in the end product. A slanted angle between the intended direction of movement of the end product and the drive's direction will create shear stress and could lead to a fatigue fracture. </div> </div>

Avoiding a pinching hazard

 CAUTION
<div style="display: flex; align-items: center;">  <div> <p>When designing your end product, you should take the drive adjustment movement into account with passive safety mechanisms and with the appropriate safety notices in your operating instructions.</p> <ul style="list-style-type: none"> • Installation methods for ensuring passive safety: Install the DUOMAT 3 CARE EASY so that none of the positions where shear and pinch hazards exist are accessible externally. </div> </div>

When preparing safety notices for the operator, be sure that your operating instructions inform the user of these points.

6.2 Installation procedure

6.2.1 An example installation

Before installing the drive, make sure that you are observing all of the safety notices found in the "Safety notices to observe during installation" section.

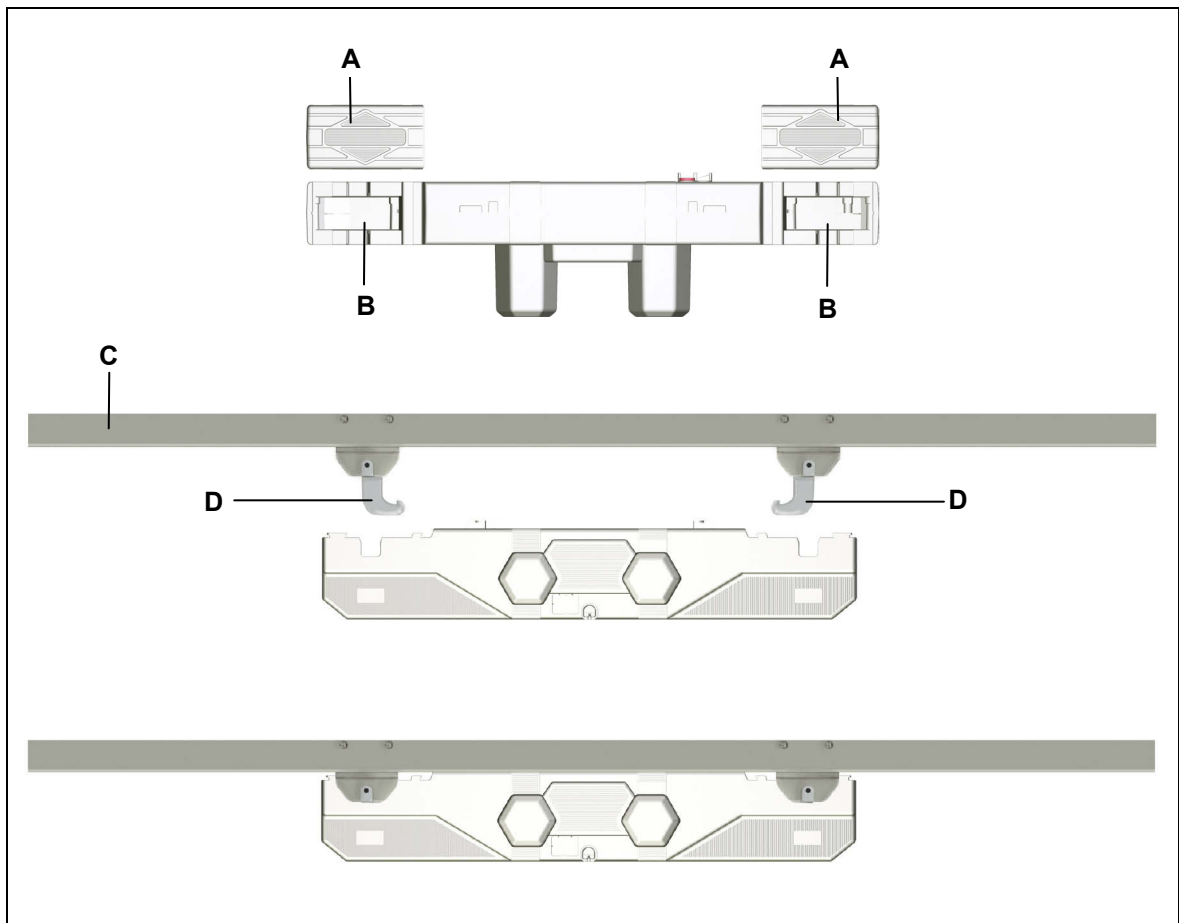

Figure 7 Installing the double drive



A Shutters

B Fitting mounts

C End product (bed)

D Brackets

- 1 Move your product into a position where it is supporting no load.

 CAUTION
 <ul style="list-style-type: none"> • Be sure to carry out work on the drive in a position so that no loads are bearing on it. Only in this way can you be sure to avoid any risks of crushing or injury. • Disconnect the batteries if you are using the battery-operated reset function. Disconnect the nine-volt block batteries.

- 2 Pull strongly on the shutters to the side (A). The slots (B) for the brackets (D) are uncovered.
- 3 Line the DUOMAT 3 CARE EASY up next to your product. The slots for the head and foot sides must be properly aligned with the correct brackets on your product (refer to the symbols on the DUOMAT 3 CARE EASY as described in Figure 3).
- 4 Push the drive in so that the brackets (D) fit into the slots (B). Press in until the tubes snap into the brackets.
- 5 Close the shutters (A) on the drive by snapping them back in. The DUOMAT 3 CARE EASY is now securely attached to the end product.
- 6 Disconnect all additional components (such as single drives or handset) from their sockets.
- 7 Close off the unused sockets using dummy plugs. The dummy plugs ensure that the sockets are properly protected against any splashed water.

6.2.2 Optional variant: Installing the strain relief mechanism to the DUOMAT 3 CARE EASY's connecting cable

The strain relief for the DUOMAT 3 CARE EASY's cable is installed on the end product as shown in Figure 8.

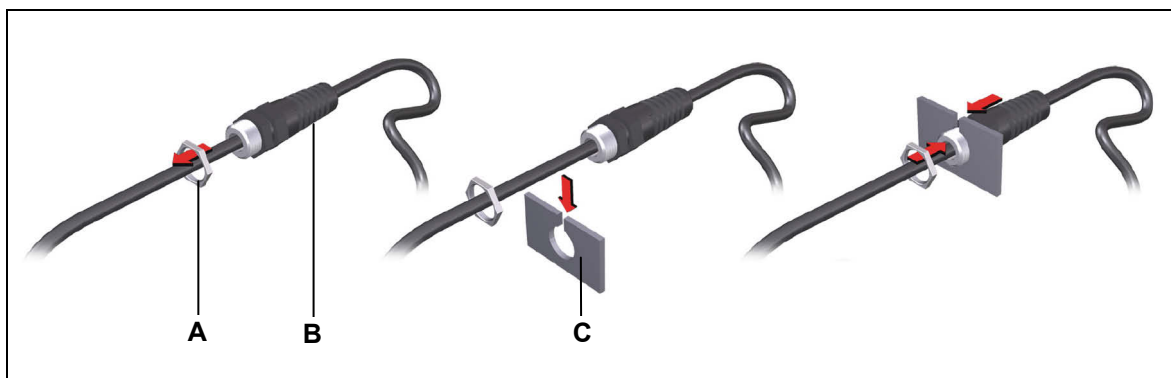

Figure 8 Mounting the strain relief cable grip (an example application)

- A** Hex nuts
- B** Strain relief
- C** End product (with slot for cable entry) that the strain relief mechanism will be attached to.

- 1 Unscrew the flat hex nut (A).
- 2 Insert the strain relief (B) through the slot in the hole in the end product (C).
- 3 Tighten the hex nut (A) back onto the strain relief cable grip.

6.2.3 Looping the handset cable through the strain relief mechanism

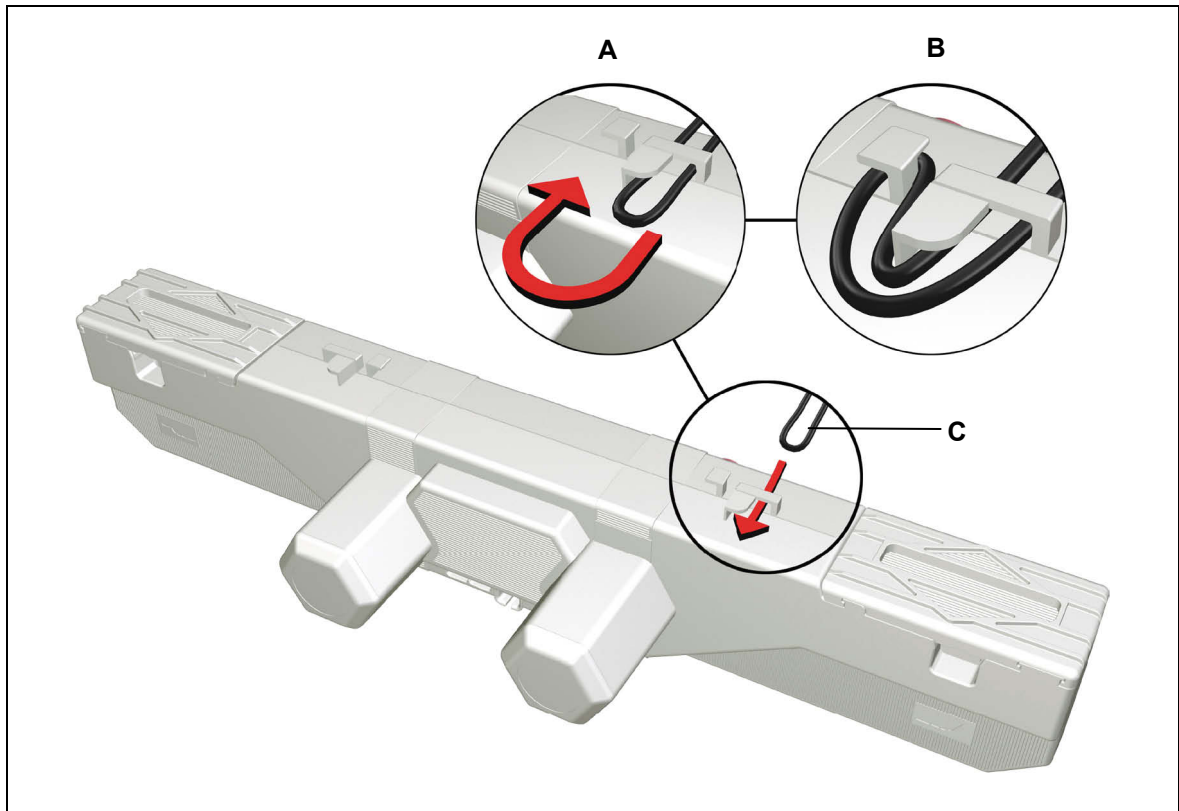

Figure 9 Looping the cable through the strain relief mechanism

A Looped-in cable

B Secured cable

C Handset cable loop

- 1 Connect the plug from the handset to the handset socket on the DUOMAT 3 CARE EASY.
- 2 Loop the handset cable through the strain relief catch and pull back gently on the loop as illustrated in Figure 9.

6.2.4 Optional variant: Route the connection cable through the strain relief

Routing the connecting cable through the mounted cable grip

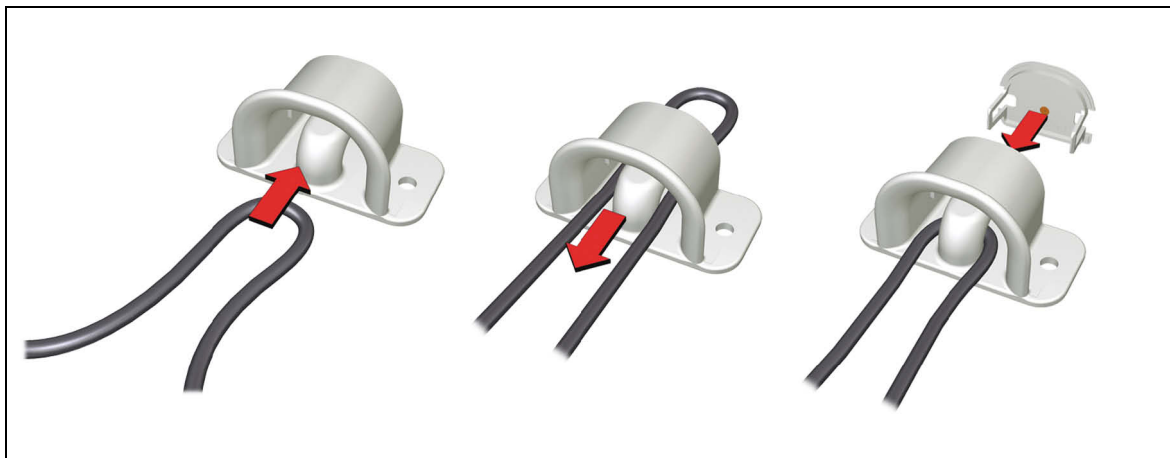

Figure 10 Routing the connecting cable through the mounted cable grip

- 1 Take a loop of the connecting cable and guide it through the strain relief cable grip, as shown in Figure 10.
- 2 Pull the cable slightly forward.
- 3 Put the cap onto the cable grip. The cap must snap on properly.

6.2.5 Electrical connection

	CAUTION
	Electrical components should be connected or disconnected only when the power supply cord (connecting cable) is unplugged.

	NOTICE
	There is a delay after the supply voltage is applied before the device actually turns on. Wait at least seven seconds before start up.

Routing the electrical cables

When routing the cables, be sure that:

- the cables cannot get jammed,
- no mechanical load (such as pulling, pushing or bending) will be put on the cables, and
- the cables cannot be damaged in any way.

Fasten all cables (especially the mains cable) to the end product using sufficient strain relief and kink prevention methods. Be sure that the design of the end product prevents the mains cable from coming into contact with the floor during transport.

6.2.6 Connecting the DUOMAT 3 CARE EASY to the PD14/PD15 power supply

The LSP plug on the DUOMAT 3 CARE EASY's cable should be plugged into the socket on the PD14/PD15 power supply's cable in order to establish the electrical connection between them.

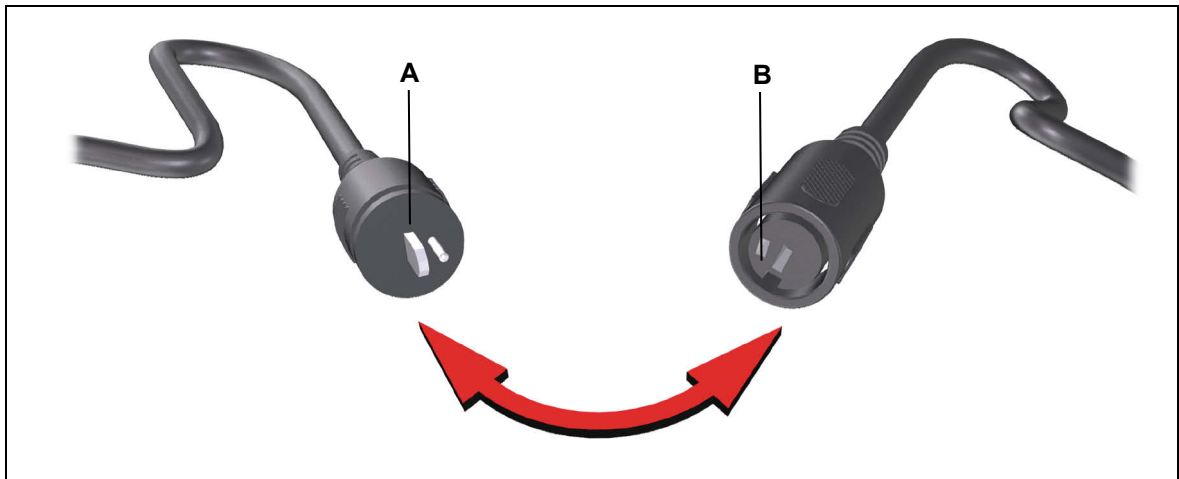



Figure 11 Connecting the DUOMAT 3 CARE EASY to the PD14/PD15 power supply



A LSP socket for the PD14/PD15 power supply

B LSP plug from the DUOMAT 3 CARE EASY



6.2.7 Dismantling

	 CAUTION
	Electrical components should be connected or disconnected only when the power supply cord (connecting cable) is unplugged.

- ▶ Certain details may change as a result of technical changes.
- 1 Move your product into a position where it is supporting no load.

	 CAUTION
	Be sure to carry out work on the drive in a position so that no loads are bearing on it. Only in this way can you be sure to avoid any risks of crushing or injury.

- 2 Unplug the plug from the connecting cable on the PD14/PD15 power supply or disconnect the power to the PD14/PD15 power supply.

	 CAUTION
	Disconnect the batteries if you are using the battery-operated reset function. Disconnect the nine-volt block batteries.



- 3 Disconnect the connecting cables from all additional components (such as single drives or handset) from their sockets.
- 4 Pull strongly on the shutters (**A**) sideways until they are completely out.
- 5 Pull out the DUOMAT 3 CARE EASY so that the brackets (**D**) are out of the slots (**B**). The DUOMAT 3 CARE EASY is now unattached and can be removed.

	NOTICE
	Be sure to support the drive's weight to prevent it falling.

- 6 Push the shutters (A) back onto the DUOMAT 3 CARE EASY so that they are not lost during transportation.

7. Operating Notes

The factual information contained within may be used when you are creating the end-product manual. The installation instructions do not contain all information required for the safe operation of the end product. They only describe the installation and operation of the drive as a partially assembled piece of machinery.

	 CAUTION
	<p>When creating the operating instructions, remember that the installation instructions are intended for qualified specialists and are not for typical users of the end product.</p>

7.1 General information

- ▶ Only a DewertOkin device should be used to control the drive since they have already been verified to work together.

Delayed start-up

After plugging the PD14/PD15's power plug into the power outlet:



	NOTICE
	<p>There is a delay after the supply voltage is applied before the device actually turns on. Wait at least seven seconds before start up.</p>

Power-on time / intermittent operations

The DUOMAT 3 CARE EASY has been designed for intermittent operations. Intermittent operation is an operational mode where the drive must pause after a specified maximum period of operation (power-on time). This protects the drive from overheating. Extreme overheating can cause a malfunction.

- ▶ The ratings plate on the drive specifies the maximum power-on time and the required pause intervals.



Avoiding electrical risks

	 CAUTION
	<p>Make sure that all live (current-carrying) parts of the drive system and power supply cannot be touched. In particular, be sure that unused power and control unit connections are covered adequately.</p>

Avoiding overheating



	NOTICE
	No more than two drives may be operated at rated load simultaneously!

Shutting off the drive

	 CAUTION
	In an emergency, disconnect the PD14/PD15 power supply from the main power supply (unplug the PD14/PD15 power supply from the power outlet). This power outlet must be accessible at all times during operation so that the cable can be unplugged. Or you can disconnect the plug on the DUOMAT 3 CARE EASY from the PD14/PD15 power supply. This will shut down the connected drive.

Avoiding cable damage

Be sure that your operating instructions inform the user about the possible cable risks.

	 CAUTION
	The cables (particularly the mains cable) should not be run over. In order to prevent injuries or drive damage, no mechanical strain should be placed on the cables.

7.2 Notice for operating with optional configuration

7.2.1 Optional: battery-operated reset function

The battery-operated reset function allows the drive system to be operated during a power outage. One or two 9-V batteries can be used to power the DUOMAT 3 CARE EASY in the event of a power outage. The batteries should only be connected when a power cut occurs. The batteries are not connected by default since they have limited capacity. They can only be used to power the reset function once. The used batteries should then be replaced and properly disposed of.

	CAUTION
The battery-operated reset function is not a safety system and does not avert danger.	

	CAUTION
Connect the nine-volt batteries first when you would like to perform a battery-operated reset. The batteries may only be used to power the reset function one time. Take out the batteries and dispose of them properly after the reset function has been carried out.	

- ▶ If the end product is under a heavy load which prevents the reset function from operating, the strain or load on the end product must first be removed before a reset can be carried out.

Connecting the nine-volt batteries

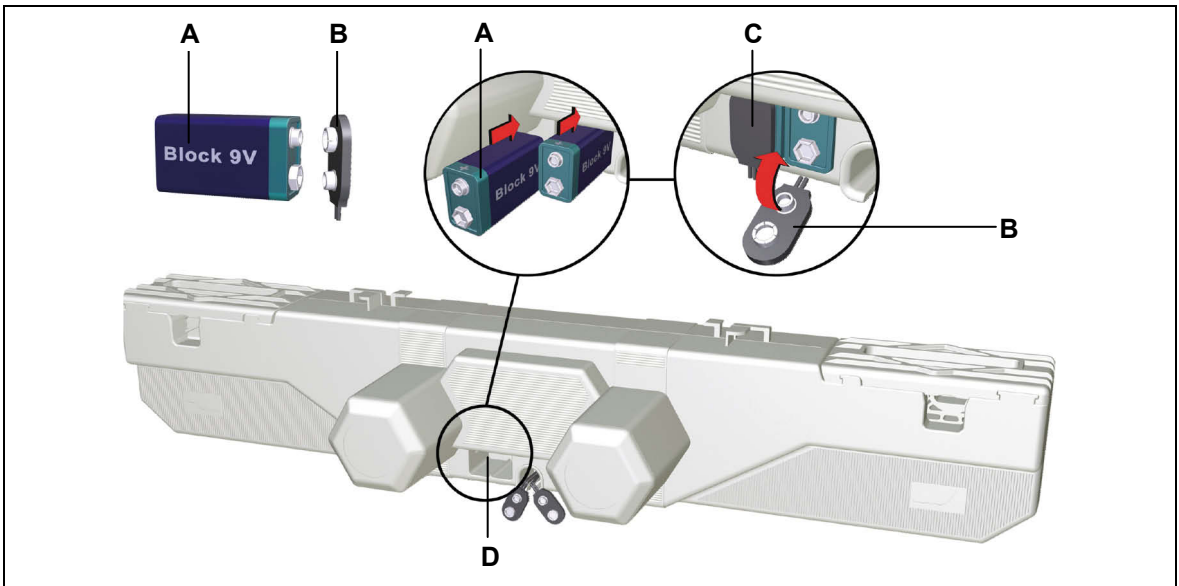



Figure 12 Connecting the 9-V batteries

- | | |
|-----------------------------------|------------------------------|
| A 9-V battery (type 6LR61) | B Battery clip |
| C Battery clip connected, | D Battery compartment |

8. Troubleshooting

This chapter describes troubleshooting methods for fixing problems. If you experience an error that is not listed in this table, please contact your supplier.

	 CAUTION
	<p>Only qualified specialists who have received electrician training should carry out troubleshooting and repairs.</p>

Problem	Possible cause	Solution
The drive or control unit is not functioning.	There is no mains supply voltage.	Connect the mains power.
	The drive or control unit is defective.	Please contact your supplier or sales agent.
		Make sure the batteries are connected.
The drive is suddenly not capable of movement.	The overheating protection or system protection has been triggered.	Remove the overload (change or remove the load). Allow the system to rest for 20 to 30 minutes with the mains power unplugged. If this does not resolve the problem, contact your supplier or distributor.
	The unit's fuse may have been triggered.	Please contact your supplier or sales agent.
	There is no mains supply voltage.	Connect the mains power.
	A cable has been disconnected (to mains power, drive or control keypad).	Check the cables and reinsert them, if required.
The battery-operated reset is not functioning.	The batteries are empty.	Check the batteries and replace if necessary.
	The batteries are not connected.	Connect the batteries.

9. Maintenance

- ▶ You should only use spare parts which have been manufactured or approved by DewertOkin. Only these parts will guarantee a sufficient level of safety.

9.1 Maintenance

Type of check	Explanation	Time interval
Check the function and safety of the electrical system.	A qualified electrician should carry out this inspection. (Refer to the "Electrical connection" section in the "Installation" Chapter.)	Periodic inspections can be carried out at intervals based on the risk assessment which you conduct for your end product.
Look over the housing periodically for any signs of damage.	Check the housing for breaks or cracks. The IP-class protection will be impaired by any breakage or cracks.	At least every six months.
Look over the plug-in connections and electrical access points for signs of damage.	Check that all electrical cables and connections are firmly seated and correctly positioned.	At least every six months.
Look over the cables for any signs of damage.	Check the connecting cables for pinching or shearing. Also check the strain relief and kink protections mechanisms, in particular after any mechanical load.	At least every six months.
Periodic functional test of the end switches.	Move the drive to the end positions in order to test the end switches.	At least every six months.

9.2 Cleaning and care

The DUOMAT 3 CARE EASY was designed so that it would be easy to clean. Its smooth surfaces simplify the cleaning process.

	NOTICE
	Never clean the DUOMAT 3 CARE EASY in an automated washing system or with a high-pressure cleaner. Do not allow fluids to penetrate into the unit. Damage to the system could result. Do not use a cleanser that contains benzene, alcohol or similar solvents.

- 1 Unplug the power cable between the DUOMAT 3 CARE EASY and the PD14/PD15 power supply before you clean the unit.

	CAUTION
	Battery-operated reset function: Disconnect the nine-volt block batteries.

- 2 Clean the DUOMAT 3 CARE EASY using a moist cloth.
- 3 Make sure that you do not damage the drive's connecting cable.

10. Disposal

10.1 Packaging material

The packaging material should be sorted into recyclable components and then disposed of in accordance with the appropriate national environmental regulations (in Germany according to the recycling law KrWG from 01.06.2012; internationally according to the EU Directive 2008/98/EC (Waste Framework Directive WFD as of 12.12.2008)).

10.2 Components of the DUOMAT 3 CARE EASY

The DUOMAT 3 CARE EASY consists of electronic components, cables and metal and plastic parts. You should observe all corresponding national and regional environmental regulations when disposing of the DUOMAT 3 CARE EASY.

The disposal of the end product is regulated in Germany by Elektro-G, internationally by the EU Directive 2011/65/EC (RoHS), or by any applicable national laws and regulations. (The end product is not regulated by the EU Directive 2002/96/EC (WEEE) and its amendment EU Directive 2003/108/EC.)



The DUOMAT 3 CARE EASY should not be disposed of with normal household waste!

10.3 Batteries

The disposal of the batteries is regulated in the EU by Battery Directive 2006/66/EC, in Germany by the BattG battery law of 25.6.2009, and internationally by any applicable national laws and regulations.



These batteries should not be disposed of with normal household waste!

Declaration of Incorporation

According to Appendix II of the EU Machinery Directive 2006/42/EC

The manufacturer:
DewertOkin GmbH
Weststraße 1
32278 Kirchlengern
Germany

declares that the incomplete machine described below

DUOMAT 3 CARE EASY

complies with the following basic requirements of the Machinery Directive (2006/42/EC):

Sections: 1.1.3; 1.3.3; 1.3.4; 1.3.7; 1.5.1; 1.5.2; 1.5.5; 1.5.6; 1.5.7; 1.5.8;
1.5.9; 1.5.10; 1.5.13; 1.6.3

You may only operate this incomplete machine after you have confirmed that the end product (into which this machine will be installed) complies with the Machinery Directive 2006/42/EC.

On request, the manufacturer is obliged to send the special documentation accompanying the partially completed machinery electronically to the appropriate national institution. The special technical documents corresponding to the machine have been created according to Appendix VII, part B.

The following person is responsible for the technical documentation: Hartmut Klimm,
Address cited above.
Tel.: 05223 979150

Kirchlengern, Germany on 26 February 2014



Dipl.-Ing. (FH) NT Walter R. Dobeslaw
Head of Development and Design Engineering

EU Declaration of Conformity

In compliance with Appendix IV of the EU EMC Directive 2004/108/EC
In compliance with Appendix III of the EU Low Voltage Directive 2006/95/EC
In compliance with Appendix VI of the EU RoHS Directive 2011/65/EU

The manufacturer:
DewertOkin GmbH
Weststraße 1
32278 Kirchlengern
Germany

declares that the following product

DUOMAT 3 CARE EASY

meets the requirements of the following EU directives:

Electromagnetic Compatibility Directive 2004/108/EC

Low Voltage Directive 2006/95/EC

RoHS Directive 2011/65/EU of the European Parliament and of the Council of 8 June 2011 on the restriction of the use of certain hazardous substances in electrical and electronic equipment

Applied standards:

- EN 55014-1/A2:2011
- EN 55014-2/A2:2008
- EN 61000-3-2/A2:2009
- EN 61000-3-3:2008
- EN 60335-1/A14:2012
- EN 62233:2008

This declaration of conformity is no longer valid if constructional changes are made which significantly change the product (i.e., which influence the technical specifications found in the instructions or the intended use)!

Kirchlengern, Germany on 26 February 2014



Dipl.-Ing. (FH) NT Walter R. Dobeslaw
Head of Development and Design Engineering

Additional information

In accordance with the EN 60601-1:2006, "Electrical medicinal devices", the following standards are used: **3E** (refer to the ratings plate for label):

EN 60601-1, section 4	General requirements
EN 60601-1, section 6	Classification
EN 60601-1, section 7.1	Labelling – general
EN 60601-1, section 7.2	Labelling – inscriptions
EN60601-1, Section 8	Protection against electrical danger, leakage currents
EN60601-1, Section 11.1	Overheating protection
EN60601-1, Section 11.2	Fire prevention
EN60601-1, Section 11.3	Design requirements for fire-resistant housing
EN60601-1, Section 13	Dangerous situations and error conditions
EN60601-1, Section 15.3	Mechanical attachment
EN60601-1, Section 15.4	Components and general construction
EN60601-1, Section 15.4.4	Replaced by EN 60601-2-52, section 201.15.4.4
EN60601-1, Section 17	Electromagnetic compatibility

In accordance with EN 60601-2-52:2010, "Particular requirements for the safety and essential performance of medical beds", the following standards have been used (refer to the ratings plate for label **3E**):

EN 60601-2-52, Section 201.6.2	Protection against electrical shock: Protection class II
EN 60601-2-52, Section 201.7.6.3	Control panel symbols (depending on model, customer requirements)
EN 60601-2-52, Section 201.9.2.2.5	Operating device with automatic reset function (e.g. IPROXX)
EN 60601-2-52, Section 201.9.2.3.1	Unintentional movement: Prevented by means of a locking mechanism (such as Control box, Supervisor, IPROXX [®] SE, IPROXX [®] , or Meditouch)
EN 60601-2-52, Section 201.9.8.3.2	Static load
EN 60601-2-52, Section 201.11.1.1	Temperatures
EN 60601-2-52, Section 201.11.6.5.101	Waterproof protection
EN 60601-2-52, Section 201.11.8	Loss of power: e.g. use of a battery, depending on customer requirements
EN 60601-2-52, Section 201.13.1.4	Special mechanical risks, depending on customer requirements: Prevented by means of a locking mechanism (such as Control box, Supervisor, IPROXX [®] SE, IPROXX [®] , or Meditouch)
EN 60601-2-52, Section 201.15.3.4.1	Mechanical strength – handset (e.g. IPROXX)
EN 60601-2-52, Section 201.15.4.4	Displays: Ready indicator is not required
EN 60601-2-52, Section BB.3.3.3	Dimensions (depending on version and customer requirements) – handset (e.g. IPROXX)
EN 60601-2-52, Section BB.3.4.1	Operational forces – handset (e.g. IPROXX)

DewertOkin GmbH
Weststraße 1
32278 Kirchlengern, Germany
Tel: +49 (0)5223/979-0
Fax: +49 (0)5223/75182
<http://www.dewertokin.de>
Info@dewertokin.de

ID-Nr.: 78668