



# **DUOMAT 9**

## **Installation Instructions**

**(Translation of the original installation instructions)**



# Foreword

## Document revision history

Version	Date	Modification, change
1.0	05/2014	First release
2.0	04/2015	Optional: AUX connection positions
3.0	01/2016	Cover/shutter, Bowden cable
4.0	05/2020	Ratings plate, toggle, declaration of incorporation and of conformity, additional information

## Disclaimer and exclusion of liability

DewertOkin is not responsible for damage resulting from:

- failure to observe these instructions,
- changes made to this product which have not been approved by DewertOkin, or
- the use of replacement parts which have not been approved or manufactured by DewertOkin.

## Contact address

DewertOkin GmbH  
 Weststrasse 1  
 32278 Kirchlengern  
 Germany  
 Tel: +49 5223/979-0  
 Fax.: +49 5223/75182  
<http://www.dewertokin.de>  
[Info@dewertokin.de](mailto:Info@dewertokin.de)

## Creation of a complete operating instruction manual for the entire end product

These instructions are only intended to be used by the end-product manufacturer. They should not be given to the operator of the end product. The factual information contained within may be used as a basis when creating the end-product manual.

The warning and danger notices are best suited for use in the end product's manual. However it is not sufficient to simply follow these notices. You should also carry out an internal risk assessment for your end product. This can then be used as the basis for the safety notices in your manual.

These installation instructions do not contain all information required to safely operate the end product. They only describe the installation and operation of the drive as partially completed machinery.

The instructions are intended for the technicians responsible for manufacturing an end product and not for the operators of the end product.



# Table of contents

<b>Foreword</b>	<b>3</b>
Document revision history	3
Disclaimer and exclusion of liability	3
Contact address	3
Creation of a complete operating instruction manual for the entire end product	3
Notice for customers in EU nations	4
<b>Table of contents</b>	<b>5</b>
<b>1. General Information</b>	<b>7</b>
1.1 Versions	7
1.2 About these installation instructions	7
1.3 Availability of this document	7
1.4 Conventions used	8
<b>2. Safety notices</b>	<b>9</b>
2.1 Proper and intended usage	9
2.2 Safety notices within the installation instruction and the operating instructions for the entire machine	10
2.3 Selection and qualification of personnel	11
2.4 Notice on safety during operations	11
2.5 Product identification	12
<b>3. Possible combinations</b>	<b>13</b>
3.1 Layout of system connections	13
<b>4. Description</b>	<b>15</b>
4.1 Components	15
<b>5. Technical specifications</b>	<b>18</b>
<b>6. Installation</b>	<b>21</b>
6.1 Safety notices to observe during installation	21
6.2 Installation procedure	22
<b>7. Operating notes</b>	<b>29</b>
7.1 General information	29
<b>8. Troubleshooting</b>	<b>35</b>

<b>9.</b>	<b>Maintenance</b>	<b>36</b>
9.1	Maintenance	36
9.2	Cleaning and care	37
<b>10.</b>	<b>Disposal</b>	<b>38</b>
10.1	Packaging material	38
10.2	Drive components	38
10.3	Batteries	38
Declaration of incorporation/installation		39
EU Declaration of Conformity		40
Additional information		41

# 1. General Information



## 1.1 Versions

The DUOMAT 9 can be operated in several different versions (configurations). The DUOMAT 9 name, as used here, also includes the DUOMAT 9+1 and DUOMAT 9+2 configurations. The "Possible combinations" chapter includes information about the different device combinations available.

## 1.2 About these installation instructions

These installation instructions must be followed closely in order to install this drive successfully and safely in the end product. These instructions are not an operating manual for the end product.

These instructions will help you to minimize danger, repair costs and down times. They will also help you to maximize the reliability and lifespan of the end product.

 <b>CAUTION</b>	
	<p>The notices in these instructions must be followed! Following the guidelines during installation and connection procedures will help to minimize:</p> <ul style="list-style-type: none"><li>• the risk of accident and injury, and</li><li>• damage to the drive system or the end product.</li></ul>

These installation instructions have been written with due care and attention. However, we cannot guarantee that the data, images and drawings are complete and correct nor do we accept any liability for the information contained therein, unless required by law.

- ▶ We reserve the right to make unannounced technical changes in the course of our continual product improvement process!

## 1.3 Availability of this document





As manufacturer of the end product, you are obligated to comply with Machinery Directive 2006/42/EC. This directive stipulates that the installation instructions must be kept on file for governmental inspection purposes.

### 1.4 Conventions used

Notices which do not relate to safety are indicated in these instructions with a triangle:

- ▶ Triangular notice symbol

#### Safety notice explanations

	<p> <b>WARNING</b></p> <p>WARNING indicates a hazardous situation which, if not avoided, could result in death or serious injury.</p>
	<p> <b>CAUTION</b></p> <p>CAUTION indicates a hazardous situation which, if not avoided, could result in minor or moderate injury.</p>
	<p><b>NOTICE</b></p> <p>NOTICE is used to address practices which are not related to personal injury but may result in damage to the product or surroundings.</p>







## 2. Safety notices

### 2.1 Proper and intended usage

The DUOMAT 9 is meant to be installed in beds.



- It provides motor adjustment capabilities for movable reclining bed parts. It should be used in conjunction with suitable fittings and mechanics:
- for care purposes,
- or in hospitals.



 <b>CAUTION</b>
 <p>This drive should only be used for the applications described above. Any other use is forbidden. Improper usage can lead to accidents or destruction of the unit. Such non-approved applications will lead immediately to the expiration of all guarantee and warranty claims on the part of the end-product manufacturer against the manufacturer.</p>

 <b>NOTICE</b>
 <p>General ESD protective measures must be observed in accordance with DIN IEC/EN 61340-5-1.</p>



### Improper usage

Be sure to follow the notices below concerning improper usage. You should include them in your product manual in order to inform the users of your end product.



 <b>WARNING</b>
 <p>The DUOMAT 9 should not be used:</p> <ul style="list-style-type: none"> <li>• in any environment where combustible or explosive gases or vapours (e.g., anaesthesiology) may be present,</li> <li>• in the proximity of open fires or other heat sources (such as furnaces, ovens or direct sunlight),</li> <li>• as a power source for toys or games,</li> <li>• in any application that will be cleaned with an automated washing system,</li> <li>• for raising and lowering loads in industrial or technical applications,</li> <li>• in a moist environment, or</li> <li>• outdoors.</li> </ul>

 <b>CAUTION</b>
 <p>The DUOMAT 9 may not be operated:</p> <ul style="list-style-type: none"> <li>• by small children,</li> <li>• by frail or infirm persons without supervision, or</li> <li>• in the proximity of small children.</li> </ul>

The DUOMAT 9 can be used by children of 8 years and older, persons with reduced physical, sensory or mental capabilities, or persons with lack of experience or knowledge when they are supervised or instructed concerning the safe use of the device and when they understand the resulting risks. Do not allow children to play with this device. The cleaning and user maintenance must not be carried out by children without supervision.

	 <b>CAUTION</b>
	You should only use spare parts which have been manufactured or approved by DewertOkin. Only these parts will guarantee a sufficient level of safety.

#### **Optional: mechanical reset function which functions without mains power**

	 <b>CAUTION</b>
	The mechanical reset function operates without mains power. It is not a safety system in the sense of security and is not intended for continuous use.

DewertOkin does not guarantee that the drive will function in the event of a power outage.

If the end-product manufacturer chooses to guarantee the functionality of the end product during a power outage, then the end-product manufacturer is responsible for arranging a mechanism to ensure this functionality.

#### **Using the drive systems in medical applications**

This DewertOkin product complies with the safety requirements found in IEC 60601-1.

We strongly recommend that the end product (including all its components) which you are manufacturing for a medical application should also comply with the safety requirements found in IEC 60601-1.

You should make sure that the mechanical movement of the motor in your end product poses no risk of injury. Conduct a risk analysis for the end product for this purpose. You should also include safety notices in the instructions for the end product and technical safeguards in your product to eliminate any risk.

## **2.2 Safety notices within the installation instruction and the operating instructions for the entire machine**

The manufacturer of the end product is only permitted to operate the DUOMAT 9 (by itself an incomplete machine)

- when the end product (for which the DUOMAT 9 is intended) is in compliance with all protective measures specified in the Machinery Directive 2006/42/EC, and
- when the manufacturer expressly declares the compliance of the end product.

The manufacturer of the end product must create a manual for the users of that product. The safety notices in the end-product manual must be written based on the end product's risk assessment.

## 2.3 Selection and qualification of personnel

This drive should only be installed into the end product by someone who has completed training in electronic motor assembly or has equivalent qualifications.

You should only install this drive when you are qualified to do so. Otherwise, a properly qualified person should be found for this task.

## 2.4 Notice on safety during operations

Basic safety rules must be followed in order to ensure that the end product can be continually operated in a safe manner. These rules must be observed while using the end product and while installing the drive.

These rules and safety measures can be categorized as follows:

- Construction measures before the installation (refer to the "Ensuring operational reliability during installation" section in Chapter "Installation").
- Safety fundamentals during the drive installation and during cable and wire routing (refer to the "Safety notices to observe during installation" section in the "Installation" Chapter).
- Using the drive in intermittent duty (refer to the "General information" section in the "Operating notes" chapter).
- Basic safety rules during operation (refer to the "Operating notes" Chapter).
- The creation of a manual for the end product which contains these and other safety rules.

### Creating a user's manual

The manufacturer of the end product must create a manual for the users of that product. The safety notices in the end-product manual must be written based on the end product's risk assessment.

## 2.5 Product identification

### 2.5.1 Ratings plate

A ratings plate on each drive specifies the exact name and serial number of the drive. It also states the technical specifications valid for that particular drive. The maximum pushing force is specified here. The following illustration shows where the specifications are located on the drive's ratings plate.

- ▶ The ratings plates shown are examples; the specifications for your drive may differ from this illustration.

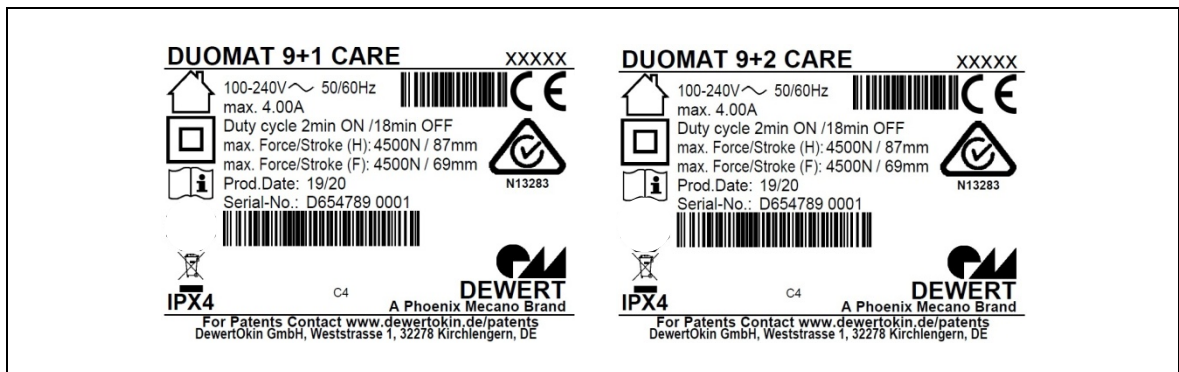







Figure 2 Ratings plate example

DUOMAT 9+1 CARE DUOMAT 9+2 CARE	Model name
xxxxxx	Article number
100-240V ~ 50/60Hz	Input voltage and frequency
max. 4.00A	Current consumption
Duty cycle 2min ON / 18min OFF	Intermittent operations: 2 minutes / 18 minutes
max. Force/Stroke	Push force / stroke (head / foot)
Prod.Date	Calendar week / year
Serial-No.	Serial number for your drive
IPX4	Protection degree
	Use in dry rooms only!
	Protection class II
	Always follow the instructions in the manual!
	Follow all special disposal instructions!
	Conformity mark

### 3. Possible combinations

The DUOMAT 9 can be combined for use with other drives. The following basic combinations are possible:

- a DUOMAT 9 with a controller keypad,
- a DUOMAT 9+1 as the main drive and a single drive used as a slave drive with a controller keypad,
- a DUOMAT 9+2 as the main drive and two drives used as slave drives with a controller keypad,

Systems can be customized by combining drives with the controller keypad and control units as needed.

DewertOkin has separate system instruction manuals containing all information and instructions needed for these systems.

- ▶ Only a DewertOkin device should be used to control the drive since they have already been verified to work together.

#### 3.1 Layout of system connections

Refer to the sticker on the drive for details about layout and positioning of the connections. The sticker is located under the sockets. It indicates the proper type of connections for the drive. The layout of the connection scheme is individual and depends on the system specifications. Figure 3 shows an example of the position of the sticker (label).

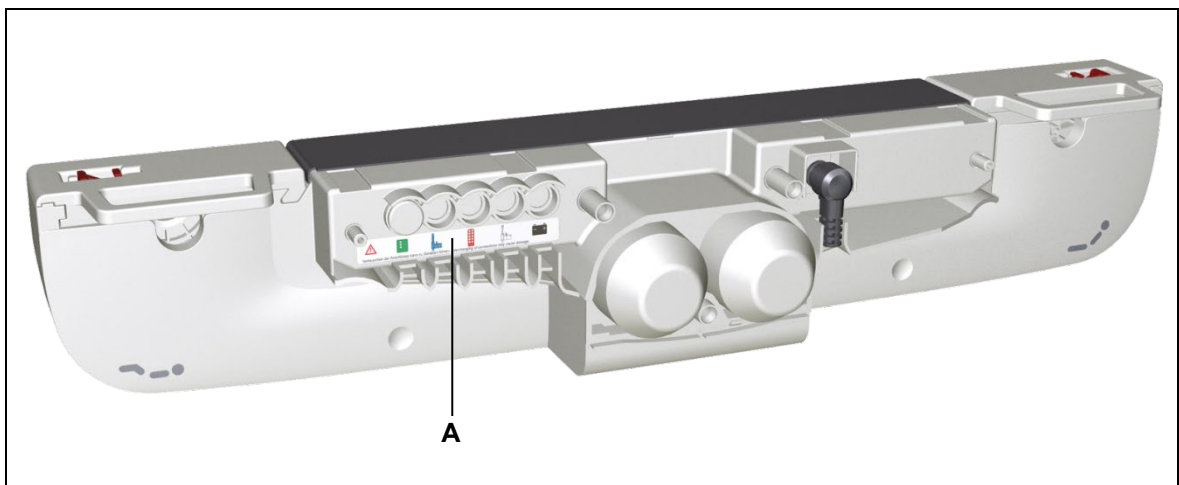

Figure 3 Position of the connection layout sticker

**A** Layout of connections



#### NOTICE

Only connect the components according to the specifications found on the drive sticker. Any other arrangement of connections may damage the drive.

**3.1.1 Optional: AUX connection positions**

The optional AUX connection label indicates the location of the AUX connection for service and maintenance personnel.

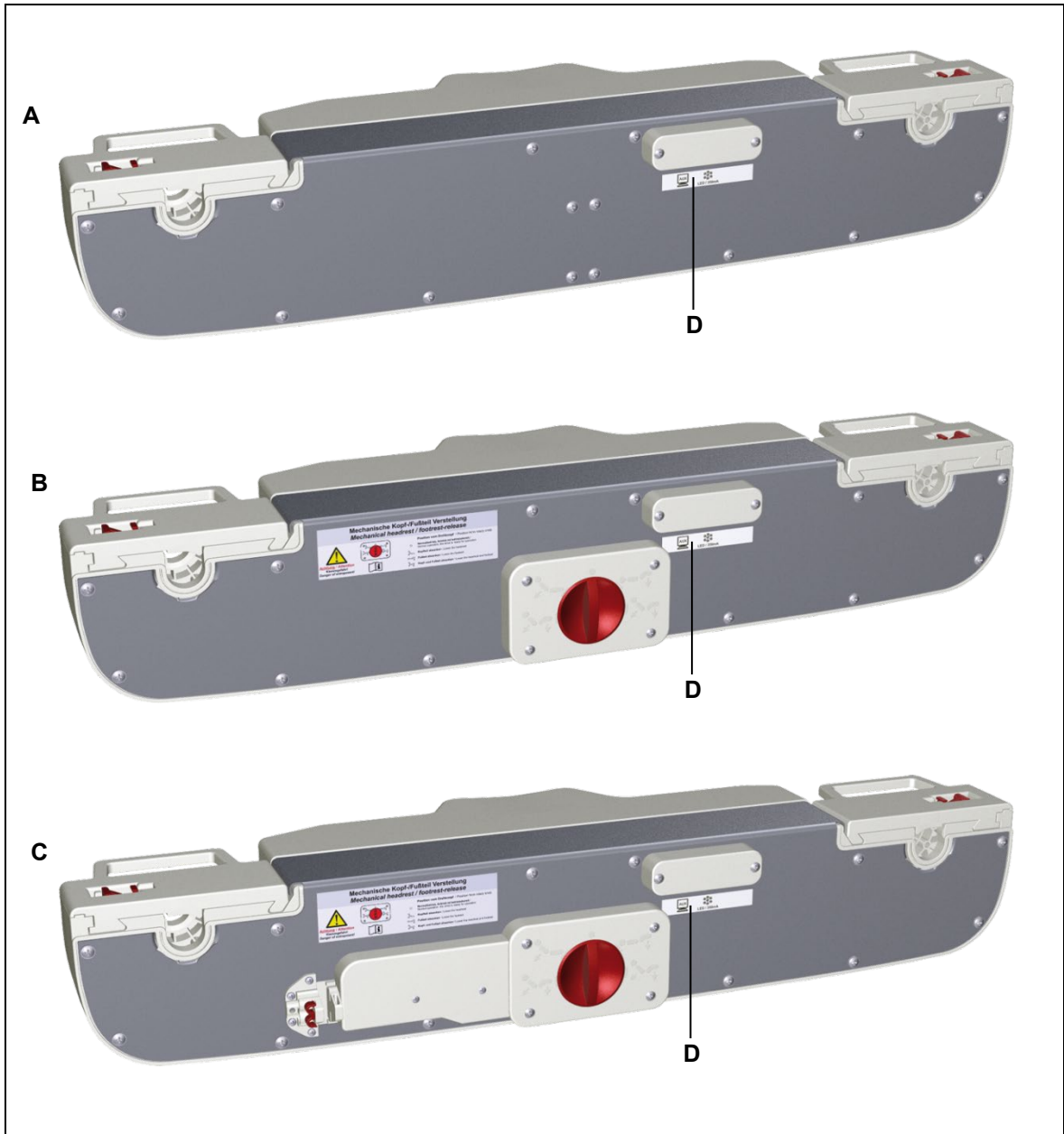

Figure 4 Optional AUX connection label on the back of the DUOMAT 9

- A** DUOMAT 9
- B** DUOMAT 9 ER/SB (with mechanical reset function)
- C** DUOMAT 9 ER/SB (with mechanical reset function) and Bowden cable retainer
- D** AUX connection label (optional)

## 4. Description

The DUOMAT 9 is an electrically driven unit that is responsible for adjusting the end product. The head and foot sections of a bed can be adjusted depending on the drive options. The drive is operated by means of a controller keypad.

The different drive models vary according to their:

- motor power,
  - number of motors,
  - optionally available mechanical reset function (using a rotary switch),
  - optionally available mechanical reset function (using a rotary switch and Bowden cable).
- We reserve the right to make unannounced technical changes in the course of our continual product improvement process!
- Refer to the "Possible combinations" chapter for more details about the different configurations of drives and controllers. Your supplier or sales agent can also provide you with more information.

### 4.1 Components

The main components of the DUOMAT 9 are its electric motors and the adjustment mechanism which is enclosed under the housing and shutters. The shutters must be opened in order to mount the drive to the end product. The brackets fastened to the end product are then inserted into these openings. A rechargeable battery can be connected to the DUOMAT 9.

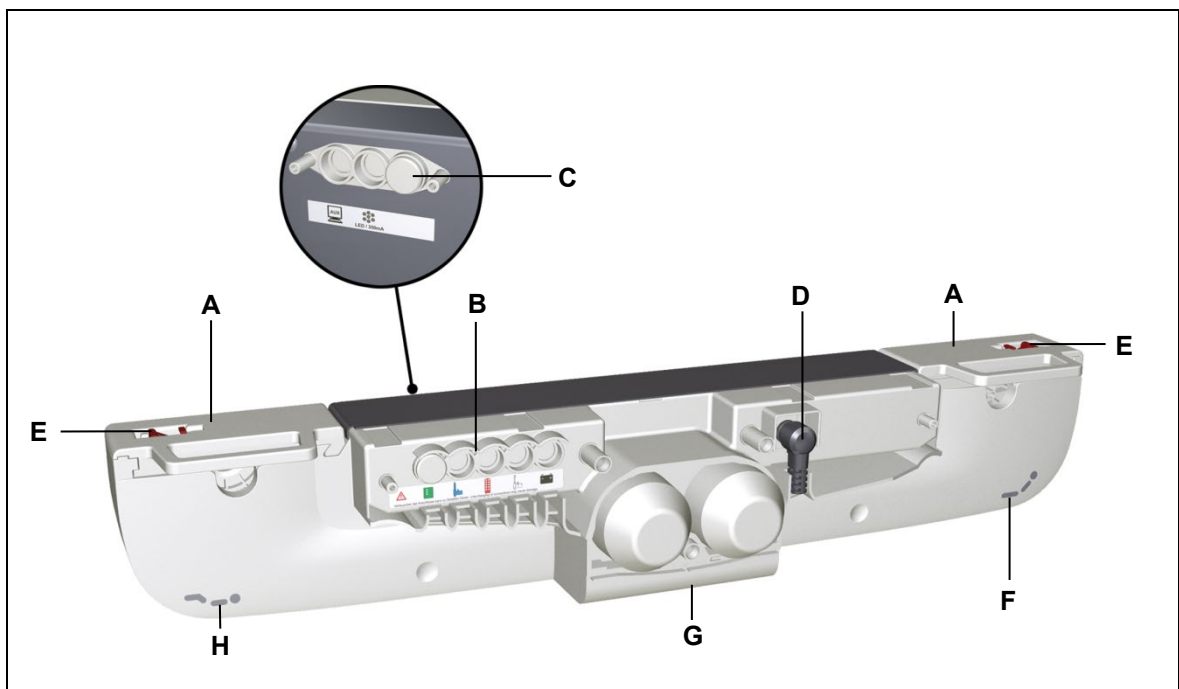

Figure 5 DUOMAT 9 (without motor cap)

- |   |  |
|---|--|
| <b>A</b> Shutters   | <b>B</b> Connections for slave drives, controller keypad, etc. |
| <b>C</b> Connections for special equipment (at rear of drive) | <b>D</b> Connection for power cord                             |
| <b>E</b> Snap-in locking device (for cover)                   | <b>F</b> Symbol for head end of bed                            |
| <b>G</b> Optional UBB (floor lighting feature)                | <b>H</b> Symbol for foot end of bed                            |

4.1.1 Configurations variants for the DUOMAT 9

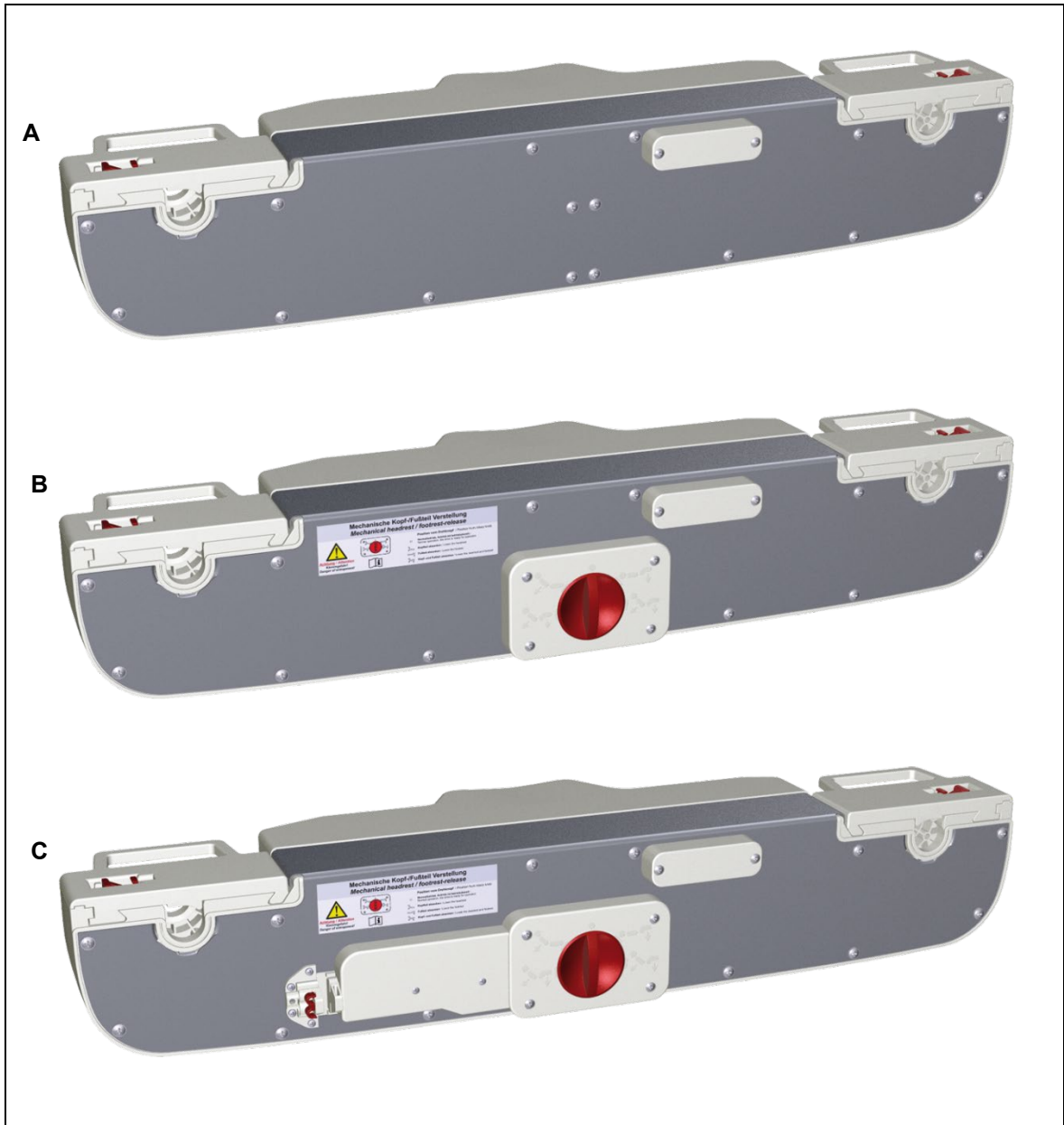



Figure 6 Rear sides of the DUOMAT 9

A DUOMAT 9



B DUOMAT 9 ER/SB (with mechanical reset function)

C DUOMAT 9 ER/SB (with mechanical reset function) and Bowden cable retainer



 <b>CAUTION</b>	 <p>The mechanical reset function operates without mains power. It is not a safety system in the sense of security and is not intended for continuous use. It should not be used to adjust the bed in emergencies!</p>
--	---



#### 4.1.2 Mains power supply connection

	 <b>WARNING</b>
	<p>Please follow these operating instructions carefully. You could be injured by fire or electrical shock if you do not follow these assembly instructions.</p>

The appropriate pluggable power supply cord is included, depending on the regional version (USA, EURO continental Europe, the UK, Australia or Japan).

	 <b>WARNING</b>
	<p>Only use the proper power cable that is permitted in your country. Be sure to use the correct plug shape (refer to Figure 7).</p>

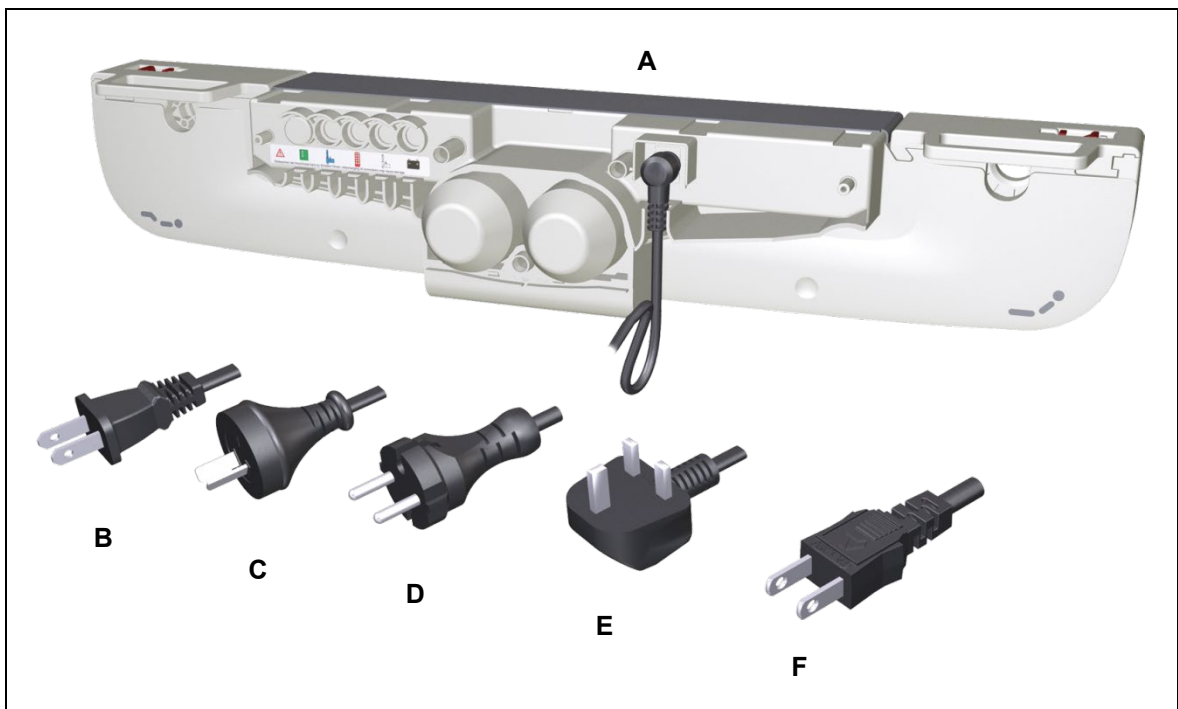

Figure 7 Power cord, regional variants

A DUOMAT 9

C Power plug (Australia)

E Power plug (United Kingdom)

B Power plug (USA)

D Power plug (EURO flat plug)

F Power plug (Japan)

## 5. Technical specifications

Mains power supply connection	100 V - 240 V AC, 50/60 Hz (refer to the ratings plate on the drive)
Current consumption at rated load	4.0 A – 1.5 A (depending on power connection)
Push force	Max. 6000 N, depending on version (refer to the ratings plate on the drive)
Pushing force of the ER/SB	Max. 4500 N, depending on version (refer to the ratings plate on the drive)
Mode of operation <sup>1</sup> under max. rated load.	Intermittent duty 2 min./18 min.
Protection class	II
Noise level	≤ 65 dB(A)
Current consumption of all drives <sup>2</sup>	Max. 5 A DC for intermittent duty 2 min / 18 min
Drive type	Double drive
Drive options	DUOMAT 9, DUOMAT 9+1, DUOMAT 9+2
Protection degree	IPX4
Stroke	87, 81, 69 mm
Length x width x height	733 mm x 191 mm x 131 mm 733 mm x 193 mm x 131 mm (ER/SB)
Axle gap distance	581 ±2 mm
Diameter of axle support	Ø 25 mm, Ø 34 mm (depending on application)
Weight	Max. 6.3 kg
<b>Ambient conditions for operation, storage and transport</b>	
Transport / storage temperature	From -20 °C to +50 °C From -4 °F to +122 °F
Operating temperature	From +10 °C to +40 °C From +50 °F to +104 °F
Relative humidity	From 30% to 75%
Air pressure	From 800 hPa to 1060 hPa
Height	< 2000 m

<sup>1</sup> Mode of operation: intermittent duty 2 min./18 min. This means that after the unit is operated with its rated load for up to two minutes it must then be paused for 18 minutes. The system can malfunction if this pause is not observed!

<sup>2</sup> No more than two drives may be operated at rated load simultaneously!

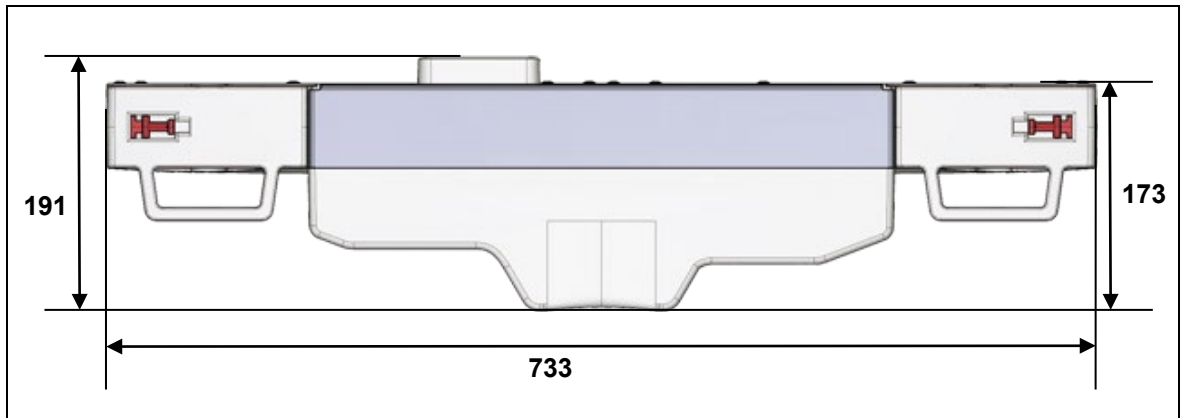

Figure 8 Dimensions of the DUOMAT 9 drive, in mm

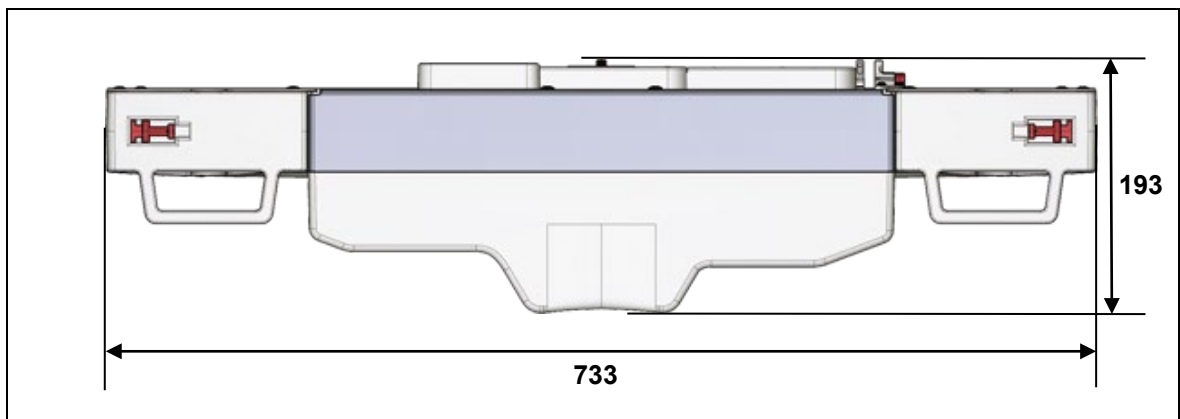

Figure 9 Dimensions of the 9 DUOMAT ER/SB (with mechanical reset function or Bowden cable retainer), in mm



Figure 10 Dimensions of the DUOMAT 9 drive, in mm

**Pivot lever**

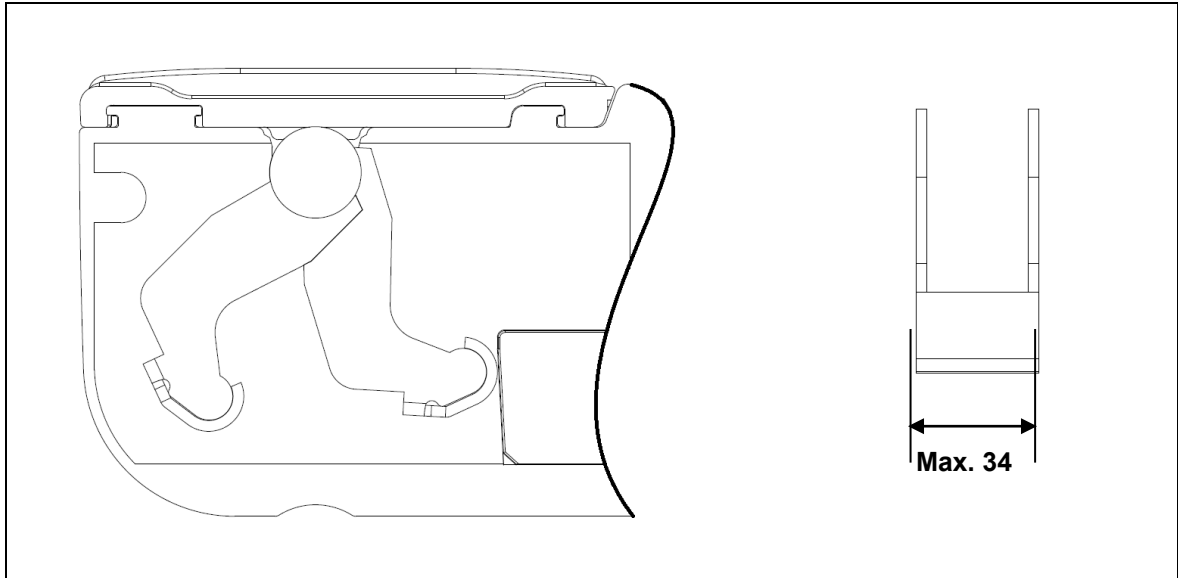

Figure 11 Pivot lever, in mm (an example)

- ▶ Only use a pivot lever with the proper dimensions.
- ▶ Make sure that you consider the amount of torque that is generated by the drive when you design the weld between the bracket and the end product.

## 6. Installation



### 6.1 Safety notices to observe during installation

Basic safety rules must be followed in order to ensure that the end product can be continually operated in a safe manner. These rules must be observed while using the end product and while installing the drive.



#### 6.1.1 Ensuring operational reliability during installation

The safety and reliability of the end product containing the DewertOkin drive can be ensured by using the proper construction methods described below.

##### Avoiding fatigue fractures

	 <b>CAUTION</b>
	<p>Drives that are incorrectly installed can undergo fatigue fractures which then create a risk of injury.</p> <ul style="list-style-type: none"> <li>• Install the drive in the end product so that it is properly aligned. This will help prevent shear stress.</li> <li>• Do not position the drive at a slanted angle when installing it in the end product. A slanted angle between the intended direction of movement of the end product and the drive's direction will create shear stress and could lead to a fatigue fracture.</li> </ul>

##### Avoiding a pinching hazard

	 <b>CAUTION</b>
	<p>When designing your product, you should take the drive adjustment movement into account with passive safety mechanisms and with the appropriate safety notices in your operating instructions.</p> <ul style="list-style-type: none"> <li>• Installation methods for ensuring passive safety: Make sure that you install the DUOMAT 9 so that none of the positions where shear and pinch hazards exist are accessible externally.</li> </ul>

When preparing safety notices for the operator, make sure that your operating instructions inform the user of these safety points.

## 6.2 Installation procedure

### 6.2.1 An example installation

Before installing the drive, make sure that you are observing all of the safety notices found in the "Safety notices to observe during installation" section.

	<b>CAUTION</b>
For the optional rechargeable battery: Disconnect the cable for the rechargeable battery from its socket before installing the DUOMAT 9.	

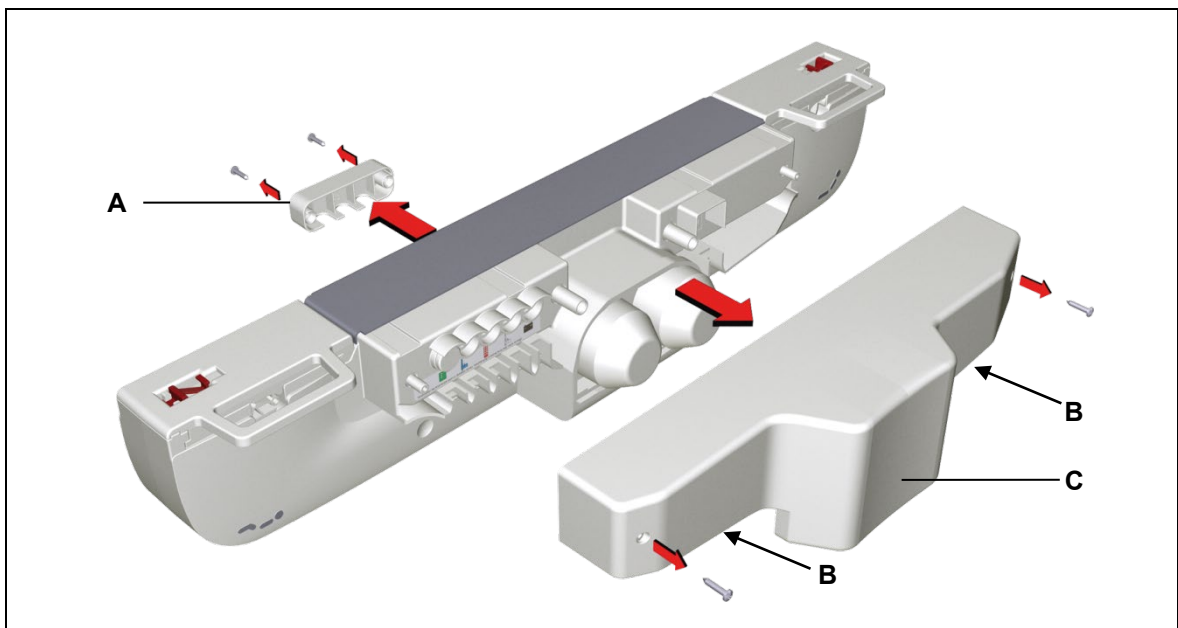



Figure 12 Removing the motor cap

**A** Cover (optional)

**B** Handholds

**C** motor cap

	<b>CAUTION</b>
Electrical components should be connected or disconnected only when the mains power cord and the battery plug (when present) are unplugged.	

1 Move your product into a position where it is supporting no load.

	<b>CAUTION</b>
Be sure to carry out work on the drive in a position so that no loads are bearing on it. Only in this way can you be sure to avoid any risks of crushing or injury.	

2 Loosen the screws of the motor cap (**C**) and remove the motor cap from the DUOMAT 9 by pulling firmly on the two handholds (**B**).

3 Loosen the screws on the cover (shown by **A** in Figure 12) at the rear of the drive and remove the cover.

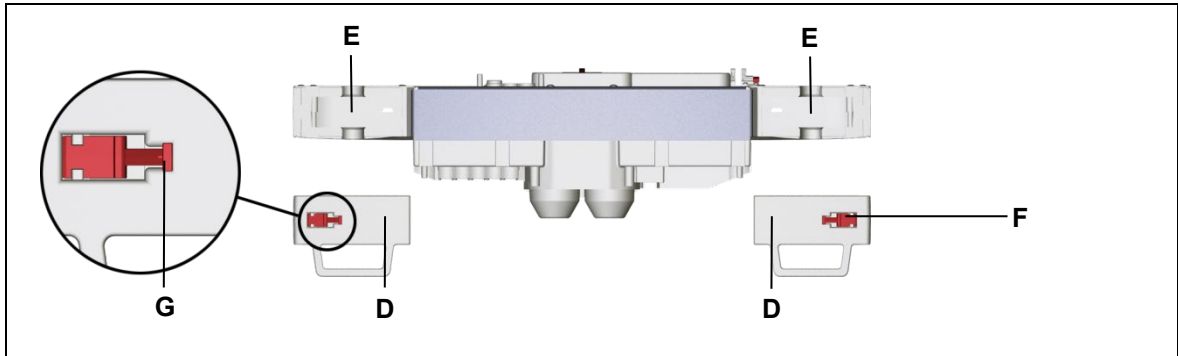

Figure 13 Removing the shutters

- D** Shutters
- E** Fitting mounts
- F** Snap-in locking device (for cover)
- G** Locking tab on shutter lock

- 4 Lift the locking tab on the shutter lock (**F**) and slide the shutter lock towards the middle of the drive. This will open the shutter.
- 5 Pull firmly on the shutters (**D**) so that they are completely removed from the DUOMAT 9.

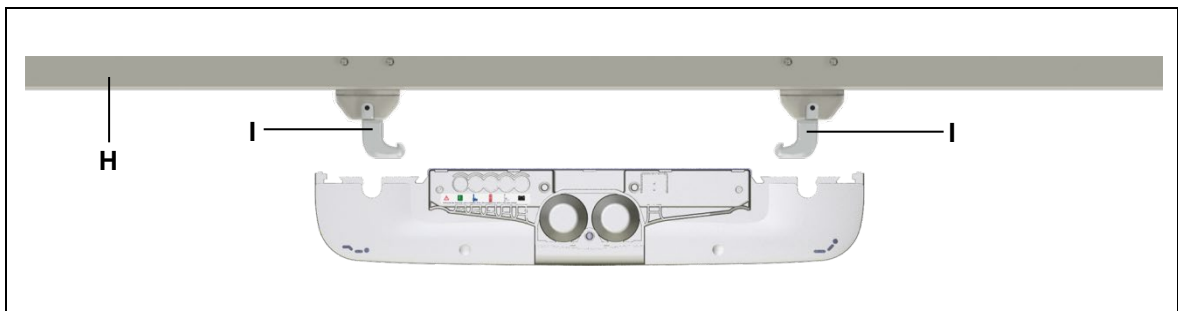

Figure 14 Positioning the double drive on the end product

- H** End product
- I** Shaft with pivot lever

- 6 Move the DUOMAT 9 into the proper position within your end product. The slots for the head and foot ends must be properly aligned with the correct brackets to your end product (**H**) (refer to the symbols on the DUOMAT 9 in Figure 5).
- 7 Slide the drive's slots (**E**) on the shaft (**I**) until the drive snaps in.
- 8 Attach the shutters to the DUOMAT 9. The drive is now firmly attached to your end product.
- 9 Lock the shutter lock (**F**) so that it locks into position (so that the locking tab (**G**) is in the recess of the shutter).

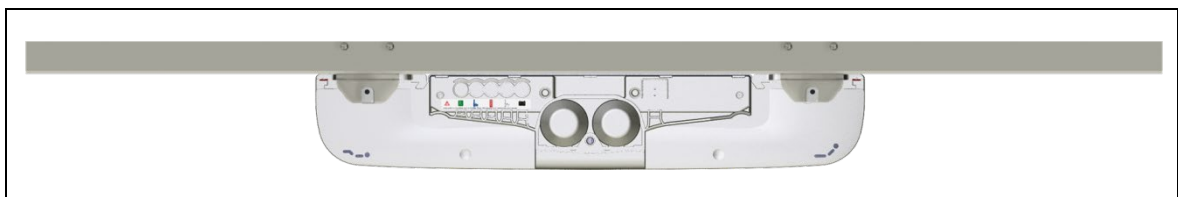

Figure 15 Double drive mounted to the end product

- 10 Connect all of the additional functionality (optional features such as slave drives, controller keypad, battery, etc.). (Refer to section 3.1 "Layout of system connections".)
- 11 Close off the unused sockets using dummy plugs. The dummy plugs ensure that the sockets are properly protected against any splashed water.

	<b>WARNING</b>
	<p>The appropriate pluggable power supply cord is included, depending on the regional version (USA, EURO continental Europe, the UK or Australia). Only use the proper power cable that is permitted in your country. Be sure to use the correct plug shape (refer to Figure 7).</p>

The power cord (**K**) should be plugged into the power socket (**J**) at the front of the DUOMAT 9 double drive.

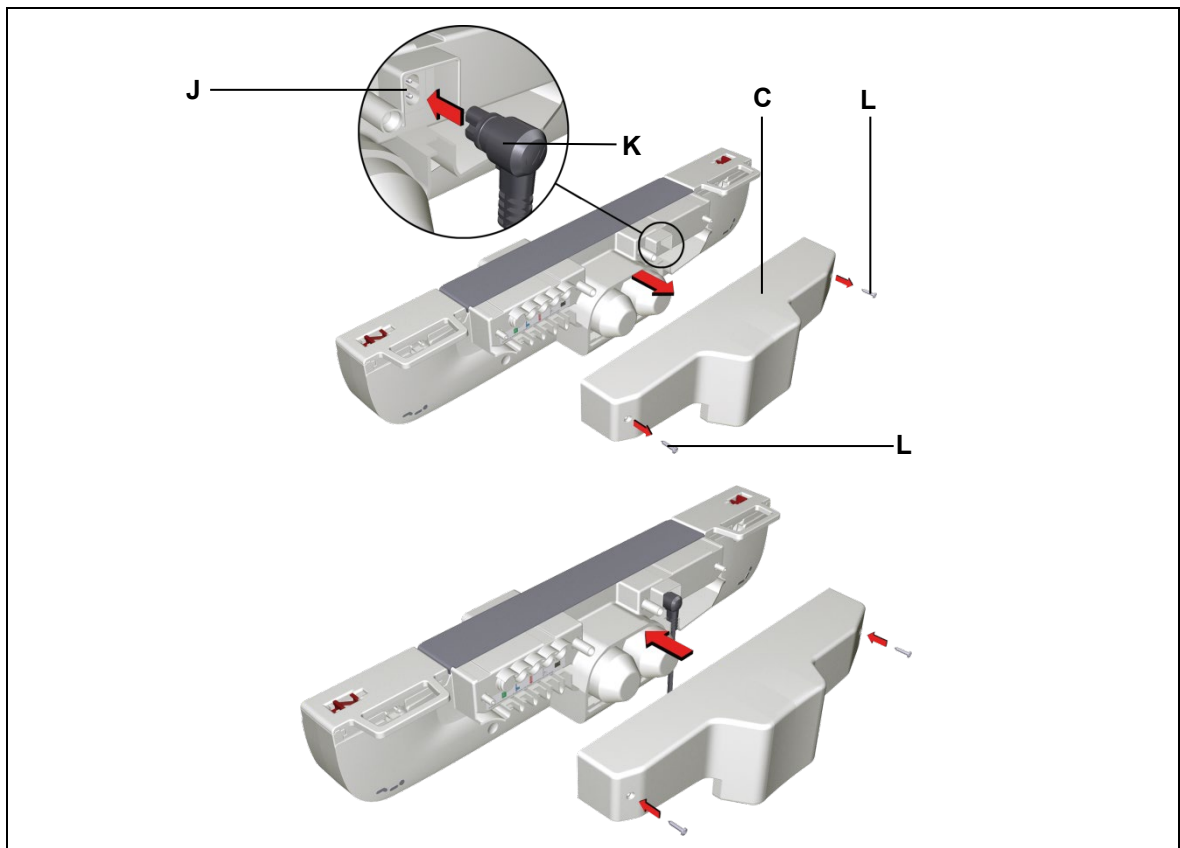



Figure 16 Plugging the power cord into the DUOMAT 9

- |                       |                     |
|-----------------------|---------------------|
| <b>J</b> Power socket | <b>K</b> Power cord |
| <b>C</b> Motor cap    | <b>L</b> Screw      |

- 12 Insert the power cord plug (**K**) into the mains socket (**J**) on the DUOMAT 9.
- 13 Screw the cover (**A**: optional) back onto the rear of the drive.
- 14 Put the motor cap (**C**) back onto the DUOMAT 9. Use the two screws (**L**) to secure the motor cap.
- 15 Insert the mains power plug into a power outlet.



After plugging the power plug into the power outlet:

	<b>NOTICE</b>
There is a delay after the supply voltage is applied before the device actually turns on. Wait at least seven seconds before beginning the commissioning.	

### 6.2.2 Option mechanical reset function, with Bowden cable attachment

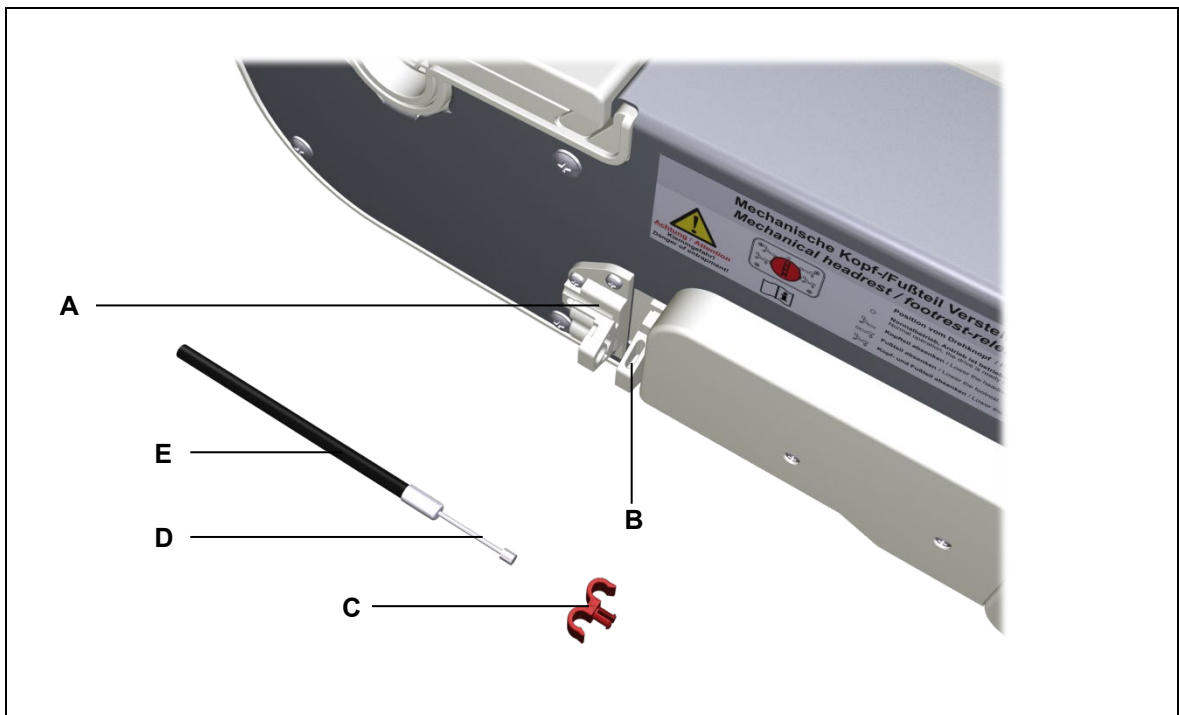

Figure 17 Mounting the drive with mechanical reset function

- |                              |                          |
|------------------------------|--------------------------|
| <b>A</b> Bowden cable holder | <b>B</b> Push-out slider |
| <b>C</b> Pull-out guard      | <b>D</b> Bowden cable    |
| <b>E</b> Bowden cable sheath |                          |

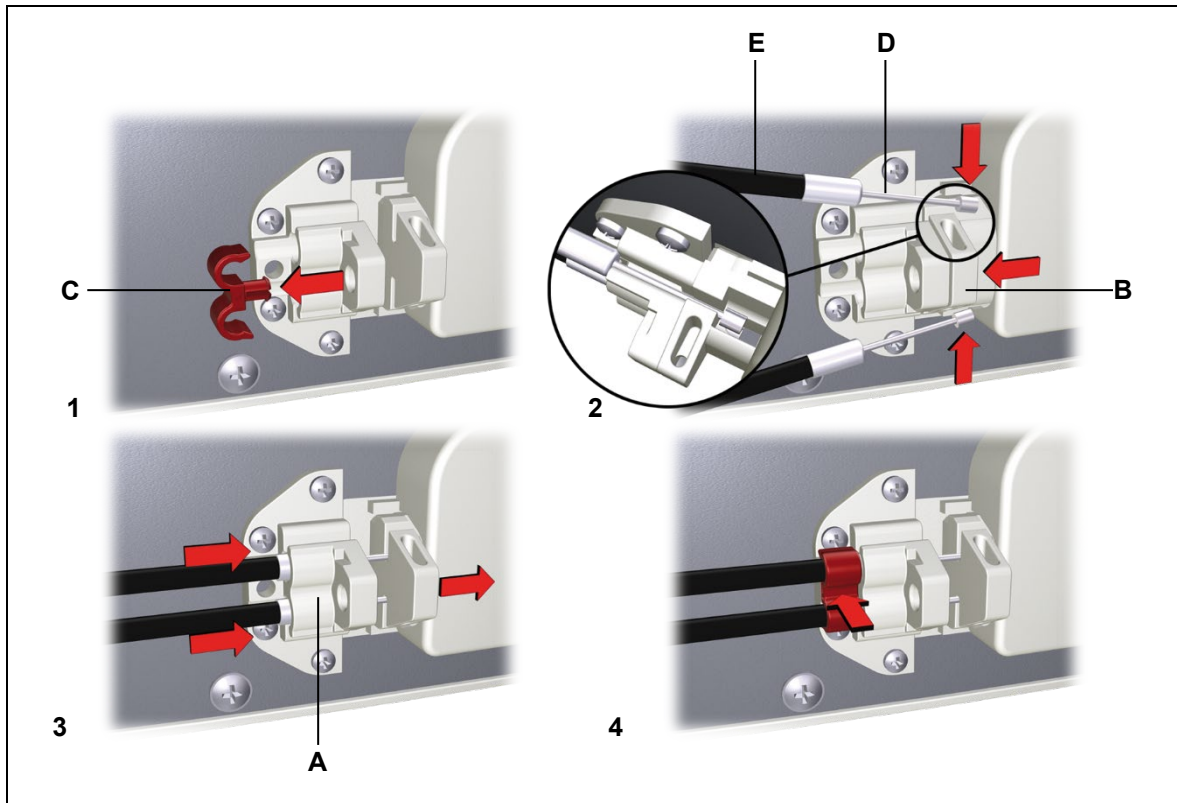





Figure 18 Installation of the Bowden cable for the mechanical reset function (optional)

- 1 Remove the pull-out guard **(C)**.
- 2 Move the push-out slider **(B)** in the direction of arrow (as shown in Figure 18.2) to the Bowden cable retainer **(A)**. Hold the push-out slider in this position.
- 3 Guide each end of the Bowden cable **(D)** through the corresponding grooves in the push-out slider **(B)** and then through the grooves in the Bowden cable retainer **(A)** (as shown in Figure 18.3).
- 4 You can now release the push-out slider **(B)**. The push-out slider move back automatically to its rest position.
- 5 Slide one or two Bowden cable sleeves **(E)** onto the Bowden cable retainer **(A)**.
- 6 Secure the Bowden cable in position using the pull-out guard **(C)**. You can hear the pull-out guard snap into position (as shown in Figure 18.4).

	 <b>CAUTION</b>
<p>Do not put too much tension on the Bowden cable. An over-strained Bowden cable could cause an accidental adjustment to occur by triggering the mechanical reset function.</p>	

- 7 Mount the Bowden cable to your end product.
  - 8 Verify that the mechanical reset function is functioning properly.
- The rotary switch maintains its function even with this optional Bowden cable connection.

### 6.2.3 Electrical connection

	 <b>CAUTION</b>
	Work on electrical components should be conducted only when the mains power connection is unplugged.



#### Routing the electrical cables



When routing the cables, be sure that:

- the cables cannot get jammed,
- no mechanical load (such as pulling, pushing or bending) will be put on the cables, and
- the cables cannot be damaged in any way.

Fasten all cables (especially the mains cable) to the end product using sufficient strain relief and kink prevention methods. Be sure that the design of the end product prevents the mains cable from coming into contact with the floor during transport.

### 6.2.4 Dismantling

	 <b>CAUTION</b>
	Work on electrical components should be carried out only when the mains power and battery plugs (when present) are unplugged.

	 <b>CAUTION</b>
	Be sure to carry out work on the drive in a position so that no loads are bearing on it. Only in this way can you be sure to avoid any risks of crushing or injury.

► Certain details may change because of technical changes.



- 1 Move your product into a position where it is supporting no load.
- 2 Pull out the mains plug from the outlet.
- 3 Loosen the screws of the motor cap and remove the motor cap from the DUOMAT 9 by pulling firmly on the two handholds.
- 4 Remove all connecting cables (such as slave drives, controller keypad, battery, etc.) from the sockets.
- 5 Option mechanical reset function, with Bowden cable attachment: Remove the Bowden cables.

	<b>NOTICE</b>
	Be sure to support the drive's weight while you open the shutters to release it.

- 6 Open the snap-in locks and pull out firmly on the shutters to remove them.
- 7 Pull out the DUOMAT 9 far enough so that the shafts are out of the slots. The DUOMAT 9 is now unattached and can be removed.
- 8 Push the shutters back onto the DUOMAT 9 so that they are not lost during transportation. Close the snap-in locks.

## 7. Operating notes

The factual information contained within may be used when you are creating the end-product manual. The installation instructions do not contain all information required for the safe operation of the end product. They only describe the installation and operation of the drive as a partially assembled piece of machinery.

	 <b>CAUTION</b>
	When creating the operating instructions, remember that the installation instructions are intended for qualified specialists and are not for typical users of the end product.

### 7.1 General information

- ▶ Only a DewertOkin device should be used to control the drive since they have already been verified to work together.

#### Power-on time / intermittent operations

The DUOMAT 9 has been designed for intermittent operations. Intermittent operation is an operational mode where the drive must pause after a specified maximum period of operation (power-on time). This protects the drive from overheating. Extreme overheating can cause a malfunction.



- ▶ The ratings plate specifies the maximum power-on time and the required pause intervals.

#### Avoiding toggle operations

You should avoid switching from one direction of travel to the opposite direction without first stopping the motor. Make sure that you pause between motions! A pause (motor stop time) can be activated using the controls.



	<b>NOTICE</b>
	You should always avoid a quick change (toggling) of directions.

#### Shutting off the drive



	 <b>CAUTION</b>
	In order to shut off the drive, unplug the mains power plug and the battery plug (when present)! The power plug must always be accessible during operations so that emergency shut-off is possible.

#### Avoiding cable damage

Be sure that your operating instructions inform the user about the possible cable risks.

	 <b>CAUTION</b>
	The cables (particularly the mains cable) should not be run over. In order to prevent injuries or drive damage, no mechanical strain should be placed on the cables.

**For floor lighting feature (UBB)**

	 <b>CAUTION</b>
Do not look directly into this light and do not point the light into other people's eyes.	

Optional: Mechanical reset functions (Bowden cable and rotary switch)

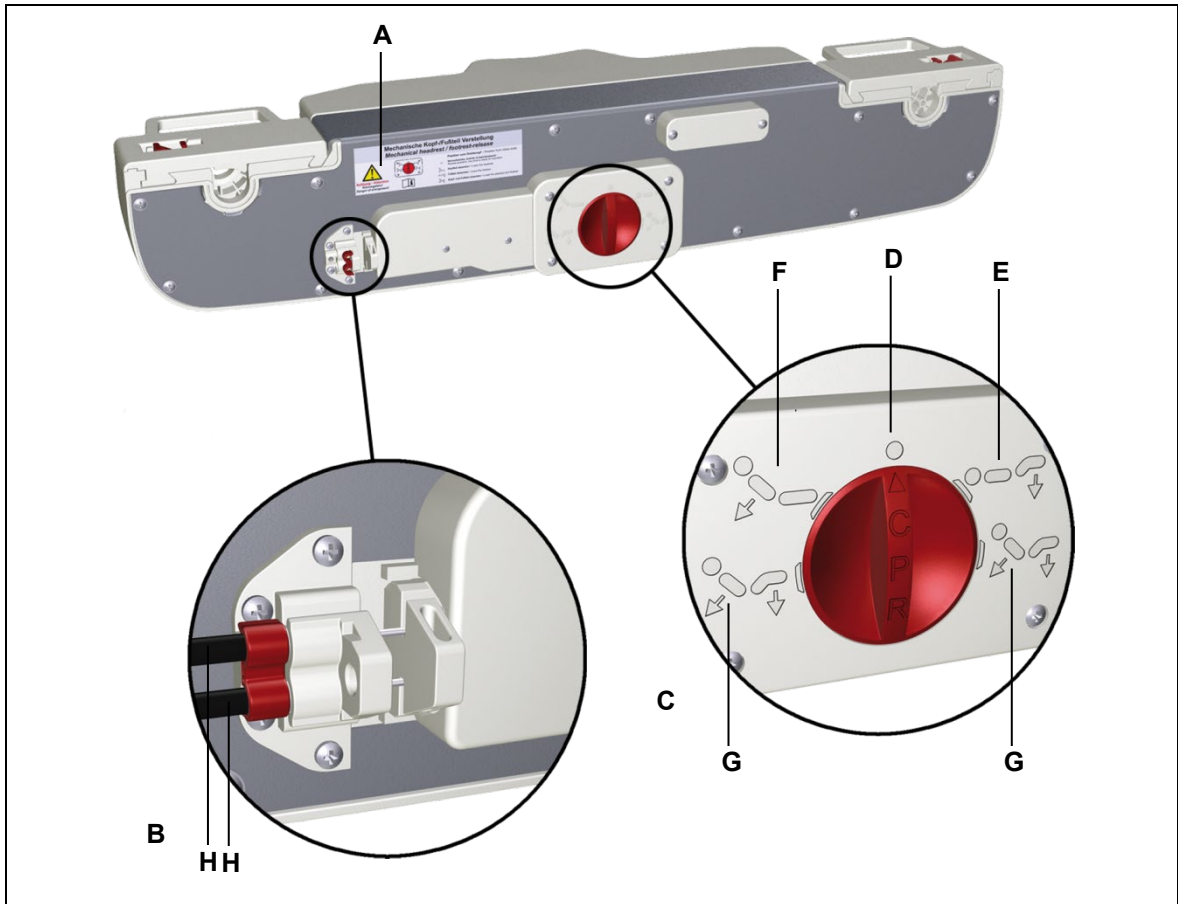

Figure 19 Mechanical reset function at the rear of the DUOMAT 9

- A** Sticker label for the mechanical reset function
- B** Attachment for the Bowden cable
- C** Mechanical reset function (rotary switch)
- D** Normal mode position
- E** Symbol: Lower the foot section
- F** Symbol: Lower the head section
- G** Symbol: Lower the foot and head sections
- H** One or two Bowden cables (for lower the head section)

Switch position	Function
	Lowering head section
	Lowering foot section
	Lowering head and foot sections
	Normal mode

**Optional: Mechanical reset function (rotary switch for head and foot sections)**

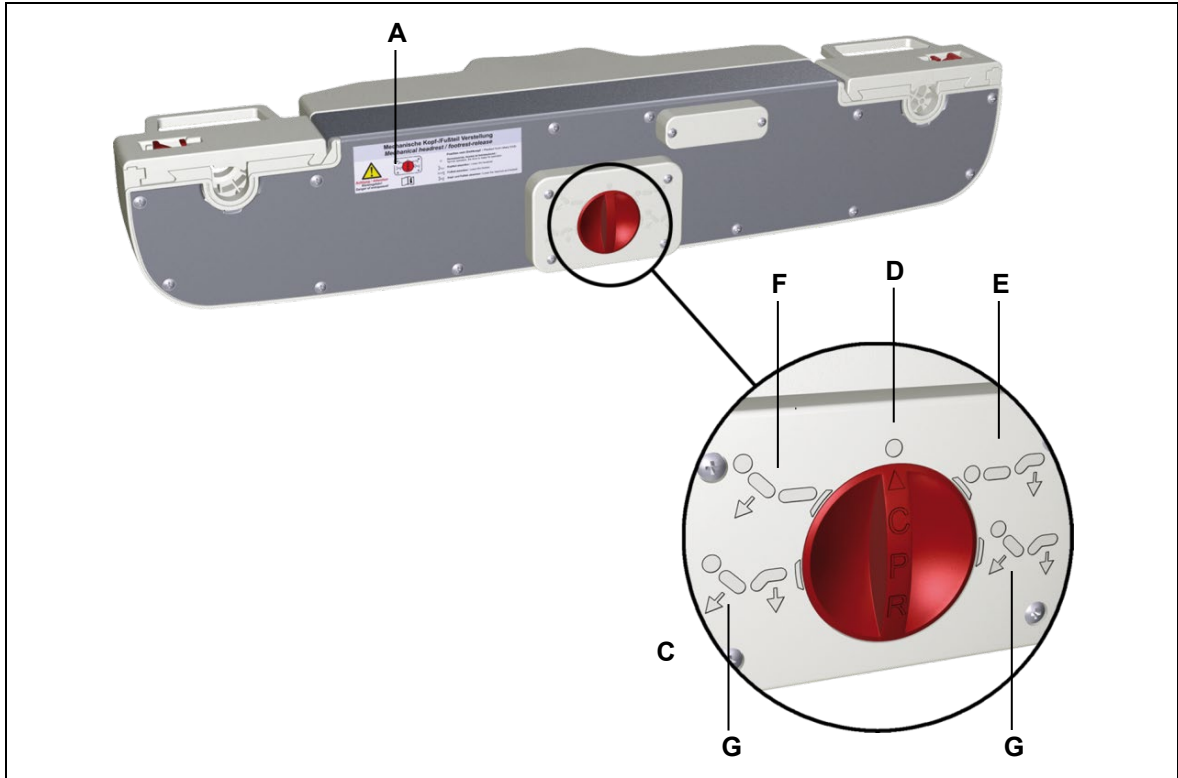

Figure 20 Mechanical reset function at the rear of the DUOMAT 9

Switch position	Function
	Lowering head section
	Lowering foot section
	Lowering head and foot sections
	Normal mode



**Optional: Mechanical reset function (rotary switch for head section)**

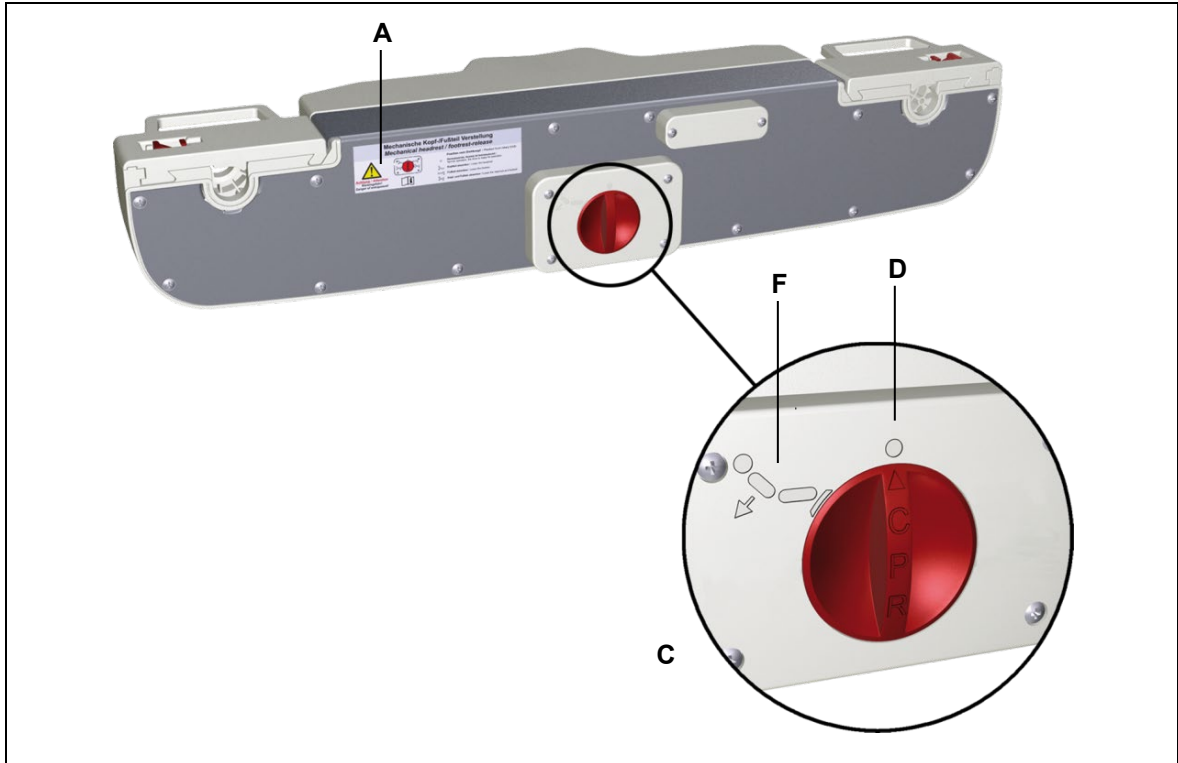





Figure 21 Mechanical reset function at the rear of the DUOMAT 9

Switch position	Function
	Lowering head section
	Normal mode

- ▶ The DUOMAT 9 (with adjustable head section) features only the "Normal mode" (B) and "Lower head section" (F) choices.
- ▶ With the mechanical reset function (using the Bowden cable), the rotary switch is used to lower the head section.

If you have purchased the DUOMAT 9 with the mechanical reset function (rotary switch or Bowden cable), then you should note the following:

- In the event of a power failure or emergency, the head and foot sections can be lowered mechanically using the mechanical reset function.
- Follow the instructions on the sticker on the back of the DUOMAT 9 (refer to Figure 19).
- Turn the rotary switch only when the unit is not operating.
- Use the Bowden cable only when the unit is not operating.
- Relieve the pressure on the head/foot section by raising it up.
- Once the head/foot section is in this unloaded state, turn the rotary switch to the mechanical reset position. Turn the rotary switch so that the desired section of your end product is selected:

 = Lowering head section,

 = Lowering foot section (optional),

 = Lowering head and foot sections (optional),



 = Normal mode.

- Depending on the design of the head and foot sections, the section may lower merely from its own weight. If the head or foot sections do not lower themselves by their own weight, you will need to help the section down by applying light pressure to the end product.
- Turn the rotary switch back to normal mode; the drive is ready for use again.
- Only turn the rotary switch when the unit is not operating. (The drive motor or motors must not be running!)

<b>NOTICE</b>	
	<p>If you are installing the DUOMAT 9 with a mechanical reset function in your end product, then it is essential that you use mechanical end stops to limit the bottom end point motion. Mechanical damage to the drive system will result if end stops are not used.</p>

## 8. Troubleshooting

This chapter describes troubleshooting methods for fixing problems. If you experience an error that is not listed in this table, please contact your supplier.

	 <b>CAUTION</b>
	<p>Only qualified specialists who have received electrician training should carry out troubleshooting and repairs.</p>

Problem	Possible cause	Solution
The controller keypad or drive system is not functioning.	There is no mains supply voltage.	Connect the mains power.
	Controller or drive system is defective.	Please contact your supplier or sales agent.
	The controller keypad is locked.	Unlock the controller keypad.
The drives can no longer be moved.	Thermocouple may have triggered or is defective.	Remove the power plug and allow the drive system to rest for 20 to 30 minutes.
	Thermocouple may have triggered or is defective.	Please contact your supplier or sales agent.
	The unit's fuse may have been triggered or may be broken.	Please contact your supplier or sales agent.
	There is no mains supply voltage.	Connect the mains power.
	A cable has been disconnected (for mains power, lifting column or controller).	Check the cables and reinsert them, if required.
	The rotary switch is not set to normal operating mode.	Turn the rotary switch to the normal operating mode position.
The motor is running but there is no motion.	The Bowden cable is not in its home position. There is too much tension on the Bowden cable.	Adjust the Bowden cable.
	The rotary switch is not set to "normal operating mode".	Set the rotary switch to "normal operating mode".

## 9. Maintenance

- ▶ You should only use spare parts which have been manufactured or approved by DewertOkin. Only these parts will guarantee a sufficient level of safety.

### 9.1 Maintenance

Type of check	Explanation	Time interval
Check the function and safety of the electrical system.	A qualified electrician should carry out this inspection. (Refer to the "Electrical connection" section in the "Installation" Chapter.)	Periodic inspections can be carried out at intervals based on the risk assessment which you conduct for your end product.
Look over the housing periodically for any signs of damage.	Check the housing for breaks or cracks. The IP-class protection will be impaired by any breakage or cracks.	At least every six months.
Look over the plug-in connections and electrical access points for signs of damage.	Check that all electrical cables and connections are firmly seated and correctly positioned.	At least every six months.
Look over the cables for any signs of damage.	Check the connecting cables for pinching or shearing. Also check the strain relief and kink protections mechanisms, in particular after any mechanical load.	At least every six months.
Periodic functional test of the end switches.	Move the drive to the end positions in order to test the end switches.	At least every six months.
Check periodically to see if the rechargeable battery is ready and operational.	If you can no longer move the drive in both directions with a fully charged battery, then you should replace the battery.	At least every four weeks.
A periodic check that the mechanical reset function is functioning properly.	Check that the mechanical reset function is functioning properly (refer to the "Optional: Mechanical reset" section in Chapter "Operating notes").  If the mechanical reset function is not triggered then the drive is broken.	At least every six months.
Periodic visual inspections, cleaning, and then a mechanical-reset functionality test (for the Bowden cable).	Check to see if the mechanical reset function (for the Bowden cable) is dirty. Clean and check function again.	At least every six months.

## 9.2 Cleaning and care

The DUOMAT 9 was designed so that it is easy to clean. Its smooth surfaces simplify the cleaning process.



### NOTICE

Never clean the drive in an automated washing system or with a high-pressure cleaner. Do not allow fluids to penetrate the drive. Damage to the system could result.

- 1 Always disconnect the mains power plug before you start to clean the drive!
- 2 Clean the DUOMAT 9 using a moist cloth.
- 3 Make sure that you do not damage the drive's connecting cable.

## 10. Disposal

### 10.1 Packaging material

The packaging material should be sorted into recyclable components and then disposed of in accordance with the appropriate national environmental regulations (in Germany according to the recycling law KrWG from 01.06.2012; internationally according to the EU Directive 2008/98/EC (Waste Framework Directive WFD as of 12.12.2008)).

### 10.2 Drive components

The DUOMAT 9 consists of electronic components, cables and metal and plastic parts. You should observe all corresponding national and regional environmental regulations when disposing of the DUOMAT 9.

The disposal of the product is regulated in Germany by Elektro-G, internationally by the EU Directive 2012/19/EC (WEEE), or by any applicable national laws and regulations.



The DUOMAT 9 should not be disposed of with normal household waste!

### 10.3 Batteries

The disposal of the rechargeable battery is regulated in the EU by the Battery Directive 2006/66/EC, in Germany by the BattG battery law of 25.6.2009, and internationally by any applicable national laws and regulations.



This battery should not be disposed of with normal household waste!

## Einbauerklärung

nach Anhang II der EU-Maschinenrichtlinie  
2006/42/EG

Der Hersteller

## Declaration of Incorporation

According to Appendix II of the EU Machinery  
Directive 2006/42/EC

The manufacturer:

DewertOkin GmbH  
Weststraße 1  
32278 Kirchlengern  
Deutschland - Germany

erklärt hiermit, dass nachstehend beschriebene  
unvollständigen Maschinen

*declares that the incomplete machines described  
below*

**DUOMAT 9<sup>1)</sup>**

**DUOMAT 9+1<sup>1)</sup>**

**DUOMAT 9+2<sup>1)</sup>**

die folgenden grundlegenden Anforderungen der  
Richtlinie Maschinen (2006/42/EG) erfüllt:

*complies with the following basic requirements of the  
Machinery Directive (2006/42/EC):*

Abschnitt:

*Sections:*

1.1.3; 1.3.3; 1.3.4; 1.3.7; 1.5.1; 1.5.2; 1.5.5; 1.5.6; 1.5.7; 1.5.8; 1.5.9; 1.5.10; 1.5.13

Die unvollständige Maschine darf erst dann in Betrieb  
genommen werden, wenn festgestellt wurde, dass  
die Maschine, in die die unvollständige Maschine ein-  
gebaut werden soll, den Bestimmungen der Richtlinie  
Maschinen (2006/42/EG) entspricht.

*You may only operate this incomplete machine after  
you have confirmed that the end product (into which  
this machine will be installed) complies with the  
Machinery Directive 2006/42/EC.*

Der Hersteller verpflichtet sich, die speziellen Unter-  
lagen zur unvollständigen Maschine einzelstaatlichen  
Stellen auf Verlangen elektronisch zu übermitteln. Die  
zur Maschine gehörenden speziellen technischen  
Unterlagen nach Anhang VII Teil B wurden erstellt.

*On request, the manufacturer is obliged to send the  
special documentation accompanying the partially  
completed machinery in electronic form to the  
appropriate national institution. The special technical  
documents corresponding to the machine have been  
created according to Appendix VII, part B.*

Für die Zusammenstellung der technischen Unter-  
lagen ist bevollmächtigt: DewertOkin GmbH  
Weststraße 1  
32278 Kirchlengern  
Tel.: 05223 979-0  
Deutschland - Germany

*For preparation of the technical documentation is  
authorized: DewertOkin GmbH  
Weststraße 1  
32278 Kirchlengern  
Phone: +49 5223 979-0  
Deutschland - Germany*



Dr.-Ing. Josef G. Groß  
Geschäftsführer / Managing Director

Kirchlengern, Germany 11 May 2020

<sup>1)</sup> Ausführung / Version: CARE, HOSP

## EG-Konformitätserklärung

Nach Anhang IV der EMV-Richtlinie 2014/30/EU

Nach Anhang IV der EU-Niederspannungsrichtlinie 2014/35/EU

Nach Anhang VI der RoHS-Richtlinie 2011/65/EU (inkl. Delegierte Richtlinie (EU) 2015/863)

Der Hersteller

## EU Declaration of Conformity

*In compliance with Appendix IV of the EMC-Directive 2014/30/EU*

*In compliance with Appendix IV of the LVD-Directive 2014/35/EU*

*In compliance with Appendix VI of the EU RoHS Directive 2011/65/EU (incl. Commission delegated Directive (EU) 2015/863)*

*The manufacturer*

DewertOkin GmbH  
Weststraße 1  
32278 Kirchlengern  
Deutschland - Germany

erklärt hiermit, dass das Produkt

*declares that the following product*

**DUOMAT 9<sup>1)</sup>**  
**DUOMAT 9+1<sup>1)</sup>**  
**DUOMAT 9+2<sup>1)</sup>**

die Anforderungen folgender EG-Richtlinien erfüllt:

*meets the requirements of the following EU directives:*

**Richtlinie über elektromagnetische Verträglichkeit 2014/30/EU**

**Electromagnetic Compatibility Directive 2014/30/EU**

**Niederspannungsrichtlinie 2014/35/EU**

**Low Voltage Directive 2014/35/EU**

**DELEGIERTE RICHTLINIE (EU) 2015/863 DER KOMMISSION vom 31. März 2015 zur Änderung von Anhang II der Richtlinie 2011/65/EU des Europäischen Parlaments und des Rates hinsichtlich der Liste der Stoffe, die Beschränkungen unterliegen.**

**COMMISSION DELEGATED DIRECTIVE (EU) 2015/863 of 31 March 2015 amending Annex II to Directive 2011/65/EU of the European Parliament and of the Council as regards the list of restricted substances.**

Angewendete Normen

*Applied standards:*

- EN 60335-1:2012/A11:2014
- EN 55014-1:2006/A1:2009/A2:2011
- EN 55014-2:1997/A1:2001/A2:2008
- EN 61000-3-2:2014
- EN 61000-3-3:2013
- EN 62233:2008
- EN 60629/A2:2013

Konstruktive Änderungen, die Auswirkungen auf die in der Montageanleitung angegebenen technischen Daten und den bestimmungsgemäßen Gebrauch haben, das Produkt also wesentlich verändern, machen diese Konformitätserklärung ungültig!

*This declaration of conformity is no longer valid if constructional changes are made which significantly change the drive system (i.e., which influence the technical specifications found in the instructions or the intended use)!*

Kirchlengern, Germany 11 May 2020



Dr.-Ing. Josef G. Groß  
Geschäftsführer / Managing Director

<sup>1)</sup> Ausführung / Version: CARE, HOSP



## Additional information

### DUOMAT 9

The following standards and norms were used in the versions<sup>1)</sup> with at least IPX4 and higher - in according to:

- EN 60601-1:2006 + A1:2013, IEC 60601-1:2005 + A1:2012 (short description: Edition 3.1), Medical electrical equipment.
- EN 60601-1-2:2015, IEC 60601-1-2:2014 (short description: Edition 4.0), EMC

IEC/EN60601-1, Section 4	General requirements
IEC/EN60601-1, Section 6	Classification
IEC/EN60601-1, Section 7.1	Labelling – general
IEC/EN60601-1, Section 7.2	Labelling – inscriptions
IEC/EN60601-1, Abschnitt 8	Protection against electrical danger, leakage currents
IEC/EN60601-1, Section 11.1	Overheating protection
IEC/EN60601-1, Section 11.2	Fire prevention
IEC/EN60601-1, Section 11.3	Design requirements for fire-resistant housing
IEC/EN60601-1, Section 13	Dangerous situations and error conditions
IEC/EN60601-1, Section 15.3	Mechanical attachment
IEC/EN60601-1, Section 15.4	Components and general construction
IEC/EN60601-1, Section 17	Electromagnetic compatibility

<sup>1)</sup> Version: CARE, HOSP

## Additional information

### DUOMAT 9

The following standards and norms were used in the versions<sup>1)</sup> with at least IPX4 and higher - in according to:

- EN 60601-2-52, IEC 60601-2-52, (Particular requirements for the safety and essential performance of medical beds)

IEC/EN 60601-2-52, Section 201.6.2	Protection against electrical shock: Protection class II
IEC/EN 60601-2-52, Section 201.7.6.3	Control panel symbols (depending on model, customer requirements)
IEC/EN 60601-2-52, Section 201.8.11.3.2	EPR-power supply lead: only $\geq 2.5$ m length
IEC/EN 60601-2-52, Section 201.9.2.2.5	Continuous operations: Control unit only with button
IEC/EN 60601-2-52, Section 201.9.2.3.1	Unintentional movement: Prevented by means of a locking mechanism (such as Control box, Supervisor, IPROXX <sup>®</sup> SE, IPROXX <sup>®</sup> , or Meditouch)
IEC/EN 60601-2-52, Section 201.9.8.3.2	Static load
IEC/EN 60601-2-52, Section 201.9.2.1	Noise level: $\leq 65$ dB(A)
IEC/EN 60601-2-52, Section 201.11.1.1	Temperature
IEC/EN 60601-2-52, Section 201.11.6.5.101	Protection against water ingress: only for $\geq$ IPX4
IEC/EN 60601-2-52, Section 201.11.8	Loss of power: e.g. use of a battery, depending on customer requirements
IEC/EN 60601-2-52, Section 201.13.1.4	Special mechanical risks, depending on customer requirements: Prevented by means of a locking mechanism (such as Control box, Supervisor, IPROXX <sup>®</sup> SE, IPROXX <sup>®</sup> , or Meditouch)
IEC/EN 60601-2-52, Section 201.15.3.4.1	Mechanical strength – handset (e.g. IPROXX <sup>®</sup> )
IEC/EN 60601-2-52, Section 201.15.4.4	Displays: Ready indicator is not required
IEC/EN 60601-2-52, Section BB.3.3.3	Dimensions (depending on version and customer requirements) – handset (e.g. IPROXX <sup>®</sup> )
IEC/EN 60601-2-52, Section BB.3.4.1	Operational forces – handset (e.g. IPROXX <sup>®</sup> )

<sup>1)</sup> Version: CARE, HOSP



DewertOkin GmbH  
Weststrasse 1  
Kirchlengern 32278, Germany  
Tel: +49 5223/979-0  
Fax.: +49 5223/75182  
<http://www.dewertokin.de>  
[Info@dewertokin.de](mailto:Info@dewertokin.de)

ID No.: 79338